

Other Tools

Wireless Video Borescope

Feature:

- With Three Comprehensive Application Mode (Single Handed Mode, Two Handed Mode, Free Handed Mode)
- Wireless imaging allows inspection results to be sent to a larger screen up to 50M away for team based analysis
- Working temperature of -20°C to +60°C
- The probe can easily fits through the spark plug hole of engine
- Water, oil, dust and scratch resistant probes (IP67)
- Obedient probe that retains required shape
- 2.0 times digital zoom function
- Horizontal picture reflection function
- Live video and photo replay on TFT display
- Snapshot and Video recording to SD card
- Voice recording through integrated microphone during video recording
- Multi lingual menu (28 languages)

CE FC RoHS



Contents:

- Console
- Handle
- 1m semi-rigid spiral shaft camera probe
- 8 GB SD card
- AV cable
- Attachment mirror
- AC Adapter

Application:

Automotive, aircraft, marine, locksmiths, electricians, law enforcement, mechanics, exterminator plumbers, welders, carpenters, HVAC repair & inspect all kinds of hard-to-reach areas.

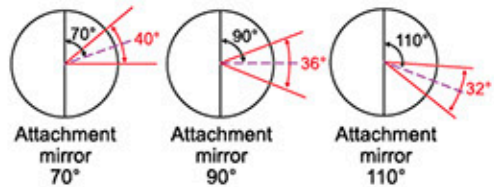

Set includes three Angle / Refracting Mirror Attachment for Ø 5.5mm Probe Video Borescope



Mirror 70°, 90°, 110°

Set includes one Angle / Refracting Mirror Attachment for Ø 3.9mm Probe Video Borescope



Mirror 110°

ITEM NO.	Probe Diameter (mm)	Probe Length (M)	Probe Type	Viewing Direction of the camera	Types of Plug Adapter (power charger)
VBRF3901	Ø3.9	1	Semi-Rigid	Forward View	A (US) E (EU) Z (AUNZ)
VBRF5501	Ø5.5	1	Semi-Rigid	Forward View	A (US) E (EU) Z (AUNZ)

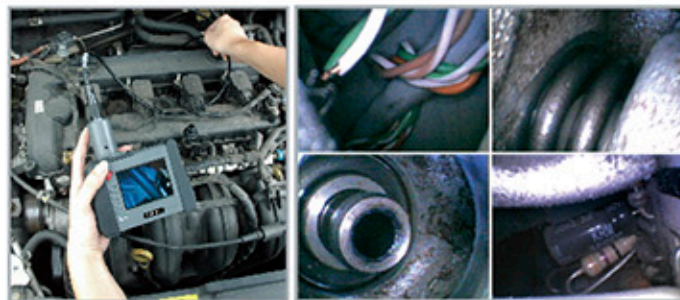

Camera System and Insert Tube	
Camera Resolution	325(H) x 250(V) = 81250 pixels
Image Sensor	CMOS
Housing	Stainless Steel
Field of View (Aperture Angle)	Horizontal field angle 46° Vertical field angle 34° Diagonal field angle 56°
Focused Depth of Field	1cm - 6cm
Protection Class	IP67
Resistance	DO NOT immerse the insert tube deeper than 1M depth and over 30 minutes.(water) DO NOT immerse the insert tube deeper than 6cm and over 10 minutes besides water.(such as lubricant oil, gasoline and etc.)
Working Temperature	0°C - 55°C
Light Source	White LED
Bend Radius	min. 15mm
Mirror Attachment (Ø3.9)	Line of Vision 110° (Aperture Angle 32°) Line of Vision 70° (Aperture Angle 40°) Line of Vision 90° (Aperture Angle 36°)
Mirror Attachment (Ø5.5)	Line of Vision 110° (Aperture Angle 32°)
Handle	
Dimension	140 x 35 x 32mm
Frequency of Wireless Transceiver	2.4 GHz 4 Channels (2414 MHz, 2432 MHz, 2450 MHz, 2468 MHz)
Battery	Battery Rechargeable Li-Polymer Battery 3.7V
Brightness Control	Variable
Audio	Integrated Microphone

Portable Video Borescope

Feature:

- Multi-function keys selection
- Working temperature of -20°C to +60°C
- The probe can easily fits through the spark plug hole of engine
- Water, oil, dust and scratch resistant probes (IP67)
- Obedient probe that retains required shape
- 2.0 times digital zoom function
- Horizontal picture reflection function
- Live video and photo replay on TFT display
- Snapshot and Video recording to SD card
- Multi lingual menu (27 languages)

CE RoHS



Contents:

- Operation panel
- 1m semi-rigid spiral shaft camera probe
- 8 GB SD card
- USB data cable
- AV cable
- Attachment mirror
- AC Adapter

Application:

Automotive, aircraft, marine, locksmiths, electricians, law enforcement, mechanics, exterminator plumbers, welders, carpenters, HVAC repair & inspect all kinds of hard-to-reach areas.

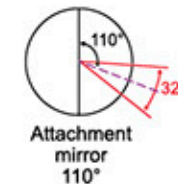

Set includes one Angle / Refracting Mirror Attachment for Ø 3.9mm Probe Video Borescope



Mirror 110°

ITEM NO.	Probe Diameter (mm)	Probe Length (M)	Probe Type	Viewing Direction of the camera	Types of Plug Adapter (power charger)
VARF3901	Ø3.9	1	Semi-Rigid	Forward View	A (US) E (EU) Z (AUNZ)

Main System (Hand Held Unit)	
Dimension	117.5 x 207 x 37mm
Display	3.5" (TFT LCD QVGA)
Video Out Format	NTSC & PAL
Video Out Interface	AV Out
Still Image Storage Format	JPEG (640 x 480 pixels)
Frame Rate	~30fps
Compression Format	MPEG4 (320 x 240 pixels)
Recording Medium	SD card up to max. 8GB
Exposure	Automatic
White Balance	Fix
S / N Ratio	42dB or more
Power	Battery Rechargeable Li-Polymer Battery 3.7V Power Supply AC 100 - 240V / 50 - 60Hz Power Consumption DC5.5 1.8A
Working Time	4 hours
Recharge Time	2 hours
Working Temperature	-20°C - 60°C
Language	English/Danish/French/Spanish/Russian/Dutch/Polish/Italian/ German/Portuguese/Japanese/Bulgarian/Traditional Chinese/ Simplified Chinese/Turkish/Swedish/Finnish/Norwegian/ Estonian/Lithuanian/Latvian/Hungarian/Czech/Slovak/ Slovene/Romanian/Greek



Camera System and Insert Tube	
Camera Resolution	325(H) x 250(V) = 81250 pixels
Image Sensor	CMOS
Housing	Stainless Steel
Field of View (Aperture Angle)	Horizontal field angle 46° Vertical field angle 34° Diagonal field angle 56°
Focused Depth of Field	1cm - 6cm
Protection Class	IP67
Resistance	DO NOT immerse the insert tube deeper than 1M depth and over 30 minutes.(water) DO NOT immerse the insert tube deeper than 6cm and over 10 minutes besides water.(such as lubricant oil, gasoline and etc.)
Working Temperature	0°C - 55°C
Light Source	White LED
Bend Radius	min. 15mm
Mirror Attachment (Ø3.9)	Line of Vision 110° (Aperture Angle 32°)

Other Tools

Two Way Articulation Probe

-NEW

Feature:

- Multi-function keys selection
- Control wheel can adjust bending angle of neck for probe
- The probe can easily fits through the spark plug hole of engine and various inspection jobs
- Maximum bending angle 300°
- Obedient probe allows to equip 70° Refracting Mirror that offers anti-reflection & particle-free images on object during inspection
- View angle rotary function allow inspection result to be sent to a TFT display (VARF Series) for team based analysis
- Brighter view images in low-light conditions
- Working temperature of -20°C to +60°C
- Water, oil, dust and scratch resistant probes (IP67)
- Obedient probe that retains required shape
- Suitable for connection to VARF Series

RoHS



Contents:

- Operation panel
- Articulation, Soft-metal camera probe
- Mirror 70°

Application:

Automotive, aircraft, marine, locksmiths, electricians, law enforcement, mechanics, exterminator plumbers, welders, carpenters, HVAC repair & inspect all kinds of hard-to-reach areas.

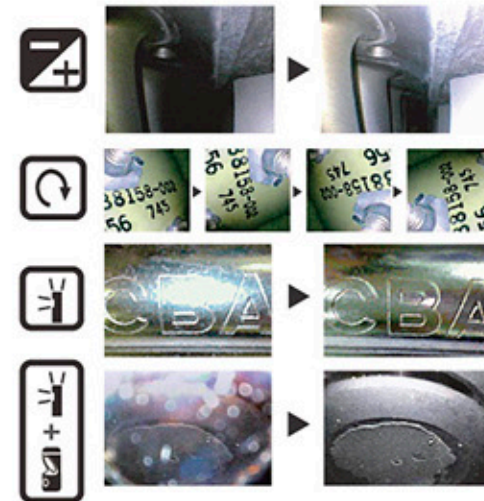

Specifications	
Dimension	228 x 35 x 53mm
Camera Resolution	VGA 640(H) x 480(V) = 307200 pixels
Image Sensor	CMOS
Camera Head Length	23.3mm
Camera Head Material	Stainless steel
Light Source	White LED
Focused Depth of Field	1cm - 6cm
Working Temperature	-20°C - 60°C
Protection Class	IP67
Video Out Format	NTSC
Articulation Angle	1m 155° view angle
Articulation Radius	48±1mm
Mirror Attachment (Ø6.0)	Line of Vision 70° (Aperture Angle 40°)



Set includes one Angle / Refracting Mirror Attachment for Ø 6.0mm Probe Video Borescope

ITEM NO.	Probe Diameter (mm)	Probe Length (M)	Probe Type	Viewing Direction of the camera
VLAB6001	Ø6.0	1	Soft-Metal	Two way 155° view

T-Type Image Guide Scope

Application:

Automotive, aircraft, marine, locksmiths, electricians, law enforcement, mechanics, exterminator plumbers, welders, carpenters, HVAC repair & inspect all kinds of hard-to-reach areas.

Feature:

- Easy to grip T-type handle
- Flexible cable for easy operation
- Bright light and adjustable focus for clearer viewing
- Angle mirrors can be attached for angle viewing

Specification:

- Material: Main unit / Handle (aluminum)
- Cable Length: 18"
- Cable Diameter: 4mm O.D.
- Bulb: HID
- Battery: CR123A (3V)
- CE approved
- Set includes 2 lithium batteries & 4 HID bulbs

ITEM NO. JJAU0418

ALUMINUM FRAMED PLASTIC CASE: W420 x D330 x H65 (mm)



Angle / Refracting Mirror (Optional attachment for T-Type Image Guide Scope)



ITEM NO.	ANGLE MIRROR (DEGREE)	10	40
JLAB0435	35	10	40
JLAB0445	45	10	40
JLAB0460	60	10	40

Scope Magnet (Optional attachment for T-Type Image Guide Scope)



ITEM NO.	JLAD0406	10

LED Rechargeable Magnet Work Lamp

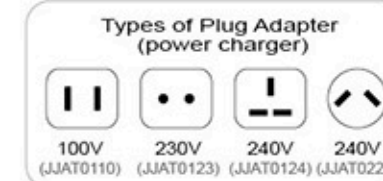

- Material of housing: Hi-impact nylon
- Clear PC material lampshade
- 30pcs LED bulbs: 20000MCD / each
- Lithium battery: 3.7V / 2400ma (Li-Ion)
- Maximum working time: approx 4 - 5 hours
- Recharge time: 5 - 6 hours
- Net weight (lamp & battery): 205g

ITEM NO.	POWER CHARGER (AC)	L (mm)	10	30
JJAT0110	100V	290	10	30
JJAT0123	230V	290	10	30
JJAT0124	240V	290	10	30
JJAT0224	240V	290	10	30



Other Tools

Industrial Lever Riveter



- 4 Interchangeable nosepieces
- Rivet steering capacity: 3.2mm(1/8"), 4.0mm(5/32")
4.8mm(3/16"), 6.4mm(1/4")
- Rivet material: Steel / Aluminum / Copper / Stainless Steel
- Length: 450mm(17-1/2")
- Material: Aluminum body, steel tube with rubber handle
- Lever design reduces physical strength for all rivet sizes
- Extra long handle provides excellent leverage

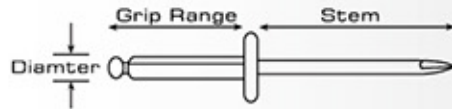

ITEM NO.	RIVET DIAMETER(mm)	1	12
JBAB3264	3.2(1/8"), 4.0(5/32"), 4.8(3/16"), 6.4(1/4")		

Scissor Action Industrial Riveter

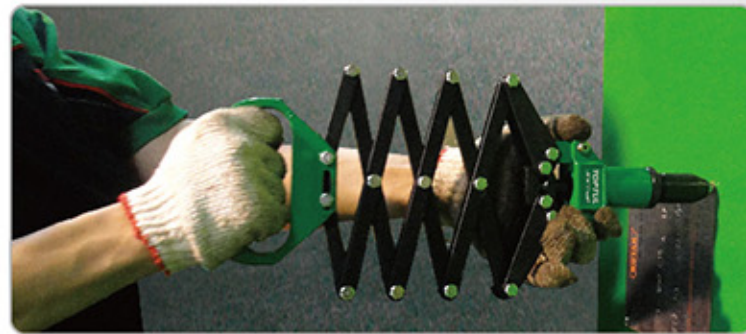
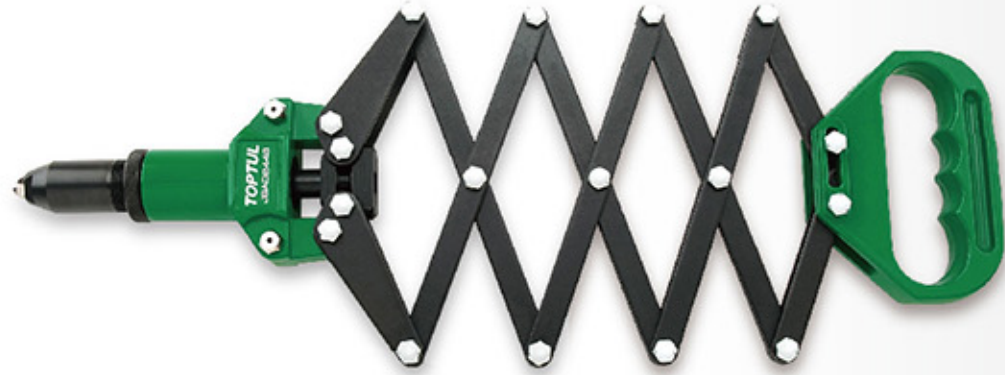

- Rugged all steel construction
- Single pull action for fast repetitive applications
- Stretching design for use in difficult access area
- Suitable for industrial and construction applications
- 4 interchangeable nose pieces: 2.4mm(3/32"), 3.2mm(1/8"), 4.0mm(5/32"), 4.8mm(3/16")
- Extended Length: 310 to 835 mm max.

ITEM NO.	RIVET DIAMETER(mm)	1	10
JBAD2448	2.4(3/32"), 3.2(1/8"), 4.0(5/32"), 4.8(3/16")		

Hand Riveter

- High-leverage chrome molybdenum handles for more power and easier operation
- Precision die-cast aluminum alloy frame constructed with extra hardened steel for longer tool life
- Extended riveter nose design for reaching confined spaces
- Full cushion grips provide optimum comfort in use
- 4 interchangeable nose pieces: 2.4mm(3/32"), 3.2mm(1/8"), 4.0mm(5/32"), 4.8mm(3/16")



ITEM NO.	RIVET DIAMETER(mm)	10	30
JBAA2448	2.4(3/32"), 3.2(1/8"), 4.0(5/32"), 4.8(3/16")		

151PCS Hand Riveter Set



ITEM NO.	CONTENTS	6 (SET)
GAAD0101	1 JBAA2448 Hand Riveter	
	30 ALCA0308 Aluminum Rivets - Ø 3.2 x 8mm	
	30 ALCA0410 Aluminum Rivets - Ø 4 x 10mm	
	30 ALCA0510 Aluminum Rivets - Ø 4.8 x 10mm	
	30 ALCB0407 Stainless Rivets - Ø 4 x 7mm	
	30 ALCB0510 Stainless Rivets - Ø 4.8 x 10mm	

METAL CASE: W370 x D154 x H50 (mm)

360° Swivel Head Hand Riveter



- Rugged all steel construction
- Aluminum alloy steel riveter head
- 360° rotating head for any angle riveting
- Perfect for use in confined spaces
- Spring loaded handle for easy loading
- 4 interchangeable nose pieces: 2.4mm(3/32"), 3.2mm(1/8"), 4.0mm(5/32"), 4.8mm(3/16")

ITEM NO.	RIVET DIAMETER(mm)	L(mm)	6	24
JBAC2448	2.4(3/32"), 3.2(1/8"), 4.0(5/32"), 4.8(3/16")	280		

Rivet Diameter (mm)	Recommended Rivet Material
2.4 (3/32")	Aluminum/Copper
3.2 (1/8")	Aluminum/Copper/Steel/Stainless Steel
4.0 (5/32")	Aluminum/Copper/Steel/Stainless Steel
4.8 (3/16")	Aluminum/Copper

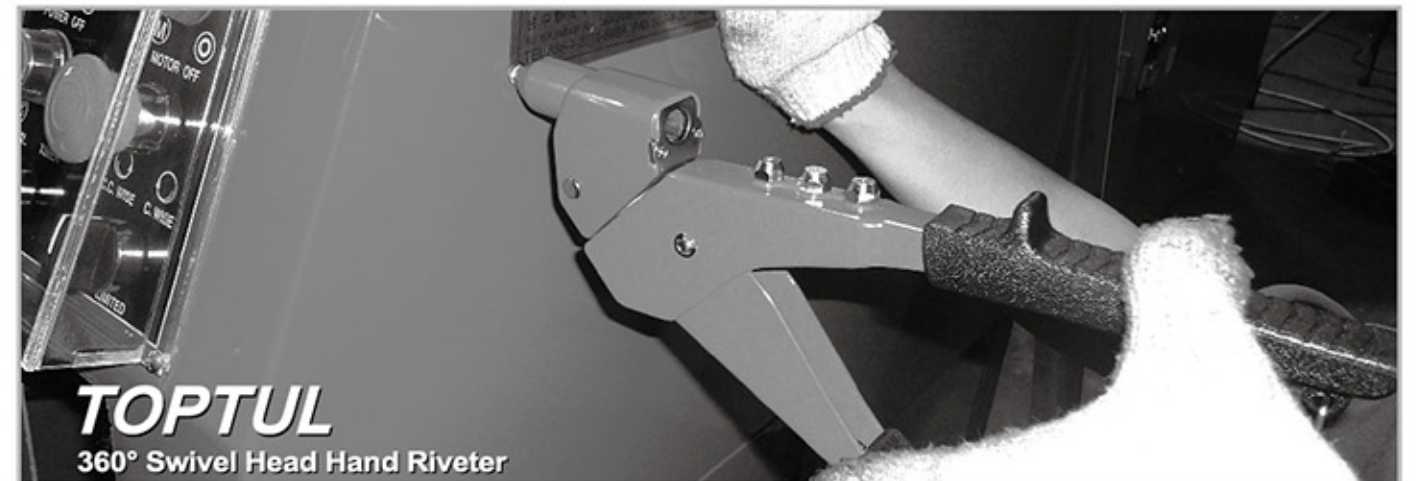

TOPTUL
360° Swivel Head Hand Riveter

Other Tools

■ **All Cast Steel Bench Vise**



- Made of robust cast steel
- Duty hardened and knurled jaw
- 360° swivel base
- Equipped with anvil and pipe jaw
- Finished with quality wrinkle green paint



ITEM NO.	SIZE(inch)	JAW OPENING(inch)	THROAT DEPTH(inch)	👤	📦
DJAC0103	3	3	2	1	1
DJAC0104	4	4	2-1/4	1	1
DJAC0105	5	5	2-5/8	1	1
DJAC0106	6	6	3	1	1
DJAC0108	8	8	3-1/2	1	1
DJAC0110	10	10	4	1	1

■ **2-Jaw Gear Puller (Sliding Arm Type)**

- Made of Chrome Vanadium Alloy Steel
- Sliding-arm universal puller with constantly parallel claws
- Puller arms design for confined spaces

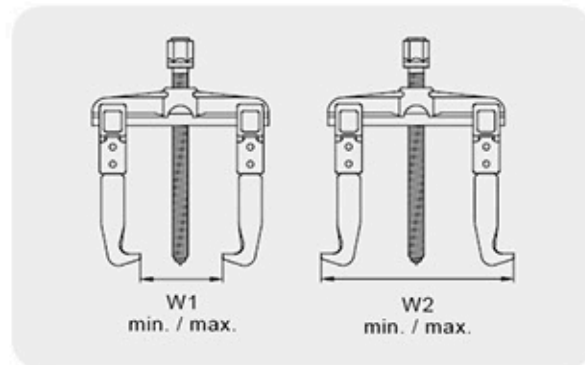

ITEM NO.	SIZE (mm)	Outside Grip Range W1 (min. / max.) mm	Inside Grip Range W2 (min. / max.) mm	👤	📦
JJAL1208	80	30 - 80	90 - 150	1	10
JJAL1212	120	30 - 120	90 - 180	1	10
JJAL1216	160	40 - 160	90 - 220	1	6
JJAL1220	200	40 - 200	90 - 260	1	6

■ **3-Jaw Gear Puller**

- Professional gear puller to remove gears, pulleys and collars from shafts effortlessly and safely. Three-point grip applies a parallel pull. Jaws and arms are forged and machined from quality alloy steel, precision heat treated for maximum durability and strength. Hardened steel center bolt with hex head for sure-grip wrench fit. Jaws can be reversed to grip firmly inside or outside gears or parts.

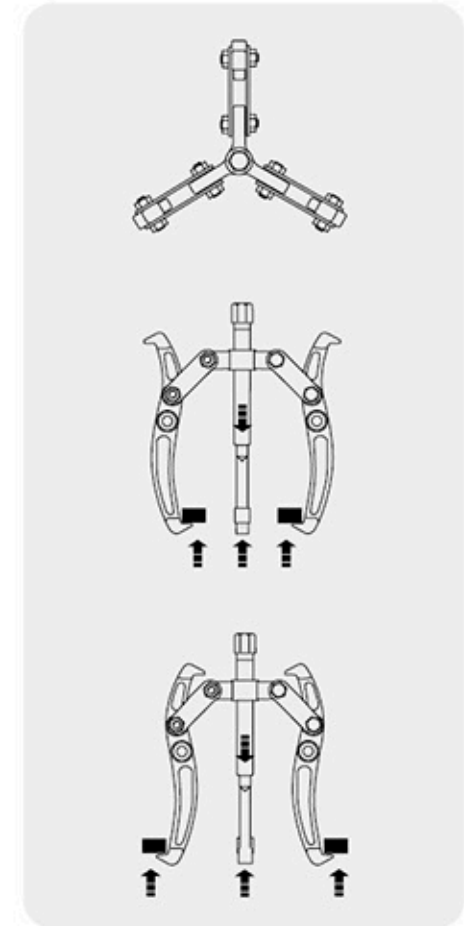

ITEM NO.	SIZE(inch)	👤	📦
JJAL0303	3	1	36
JJAL0304	4	1	18
JJAL0306	6	1	8
JJAL0308	8	1	4
JJAL0312	12	1	2

■ **2-Jaw Gear Puller**

- Professional gear puller to remove gears, sprockets, arings and pulleys effortlessly and safely. Jaws and arms are forged and machined from quality alloy steel, precision heat treated for maximum durability and strength. Hardened steel center bolt with hex head for sure-grip wrench fit. Jaws can be reversed to grip firmly inside or outside gears or parts.

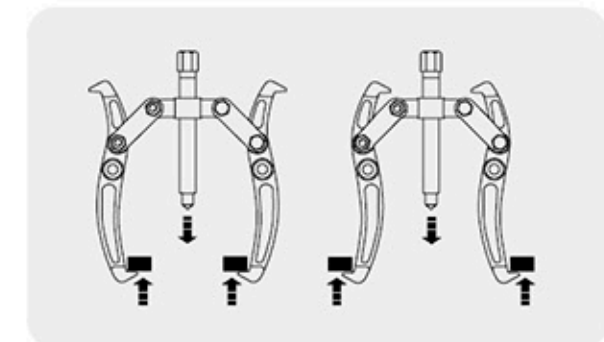

ITEM NO.	SIZE(inch)	👤	📦
JJAL0203	3	1	40
JJAL0204	4	1	32
JJAL0206	6	1	12
JJAL0208	8	1	5
JJAL0212	12	1	2

Air Operated Continuous Flow Grease Gun

Pistol Grip Type

W/ 6" Rigid Tube & 12" Flexible Hose

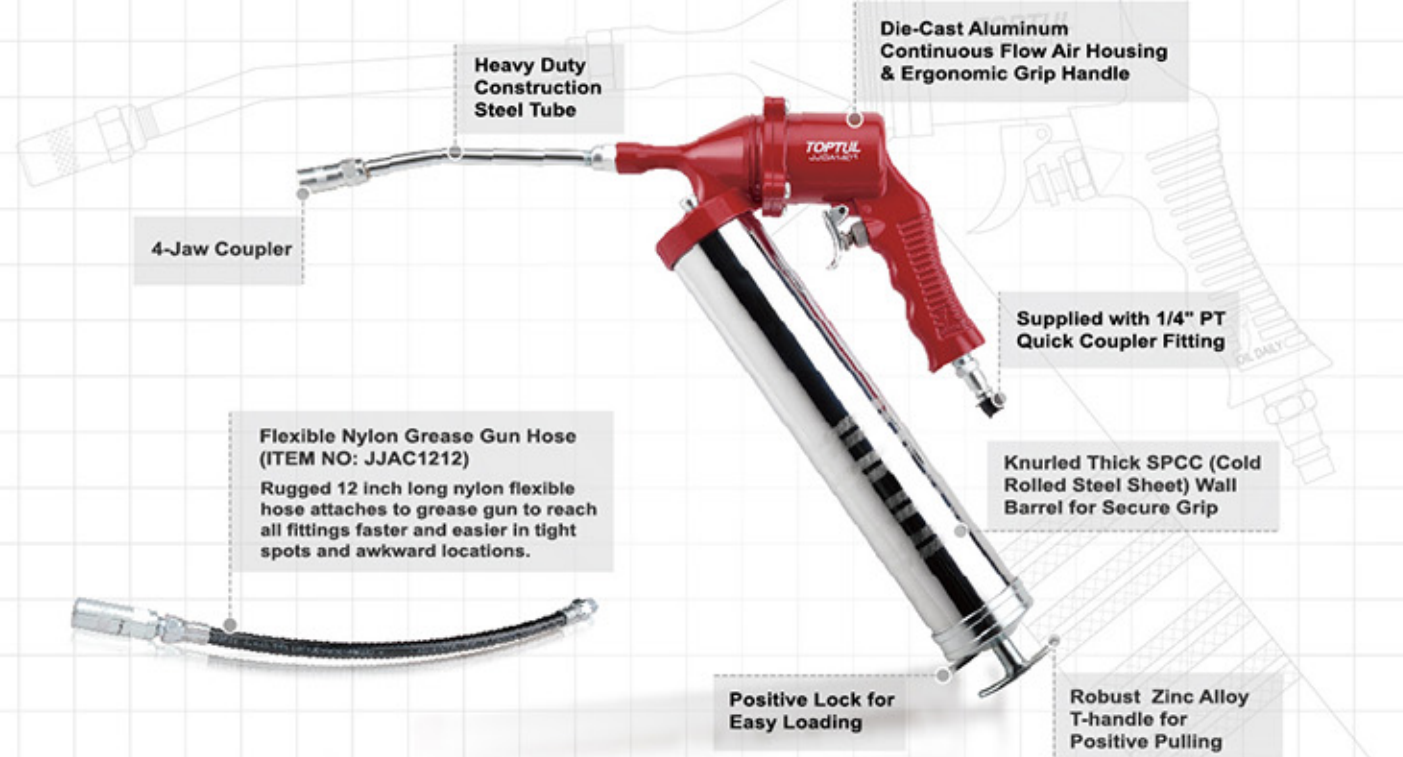

Air Operated Continuous Flow Grease Gun

■ Air Operated Continuous Flow Grease Gun (Pistol Grip Type)
W/ 6" Rigid Tube & 12" Flexible Hose



- 4-Jaw Coupler for Secure Grip
- Air Operating Range: (40:1 Pressure Ratio)
Air supplied input 60 - 150 psi (4.2 - 10.3 bar) / output 2,400 - 6,000 psi (165 - 412 bar)
- Working Pressure:
Recommend air supplied input 90 psi (6.2 bar) / output 3,600 psi (250 bar)
- Grease Coupler Thread: 1/8 inch x 28PT / Air Inlet Thread: 1/4 inch x 19PT
- Use standard 14 oz. grease cartridge
- Ideal for use in factory maintenance, automobiles and etc.

ITEM NO.	CONTENTS	10 (SET)
JGAE0204	<ul style="list-style-type: none"> ■ JJCA1401 Air Operated Continuous Flow Grease Gun (Pistol Grip Type) W/ 6" Rigid Tube Standard 14 oz. Cartridge, Pressure filler, Bulk 400 c.c., L=15" (385mm) ■ JJAC1212 Flexible Nylon Grease Gun Hose L=12" (300mm) 	

■ Air Operated Continuous Flow Grease Gun (Pistol Grip Type)
W/ 6" Rigid Tube



- 4-Jaw Coupler for Secure Grip
- Air Operating Range: (40:1 Pressure Ratio)
Air supplied input 60 - 150 psi (4.2 - 10.3 bar) / output 2,400 - 6,000 psi (165 - 412 bar)
- Working Pressure:
Recommend air supplied input 90 psi (6.2 bar) / output 3,600 psi (250 bar)
- Grease Coupler Thread: 1/8 inch x 28PT / Air Inlet Thread: 1/4 inch x 19PT
- Use standard 14 oz. grease cartridge
- Ideal for use in factory maintenance, automobiles and etc.

ITEM NO.	CAPACITY	10
JJCA1401	Standard 14 oz. Cartridge Pressure filler, Bulk 400 c.c., L=15" (385mm)	

■ Lever Type Grease Gun (Variable Stroke) - W/ 6" Rigid Tube

- Electric plated finish for long service life
- Short stroke "lever action" for easy use
- Vented head cap for easy filling
- Variable stroke action (2-stage compression)

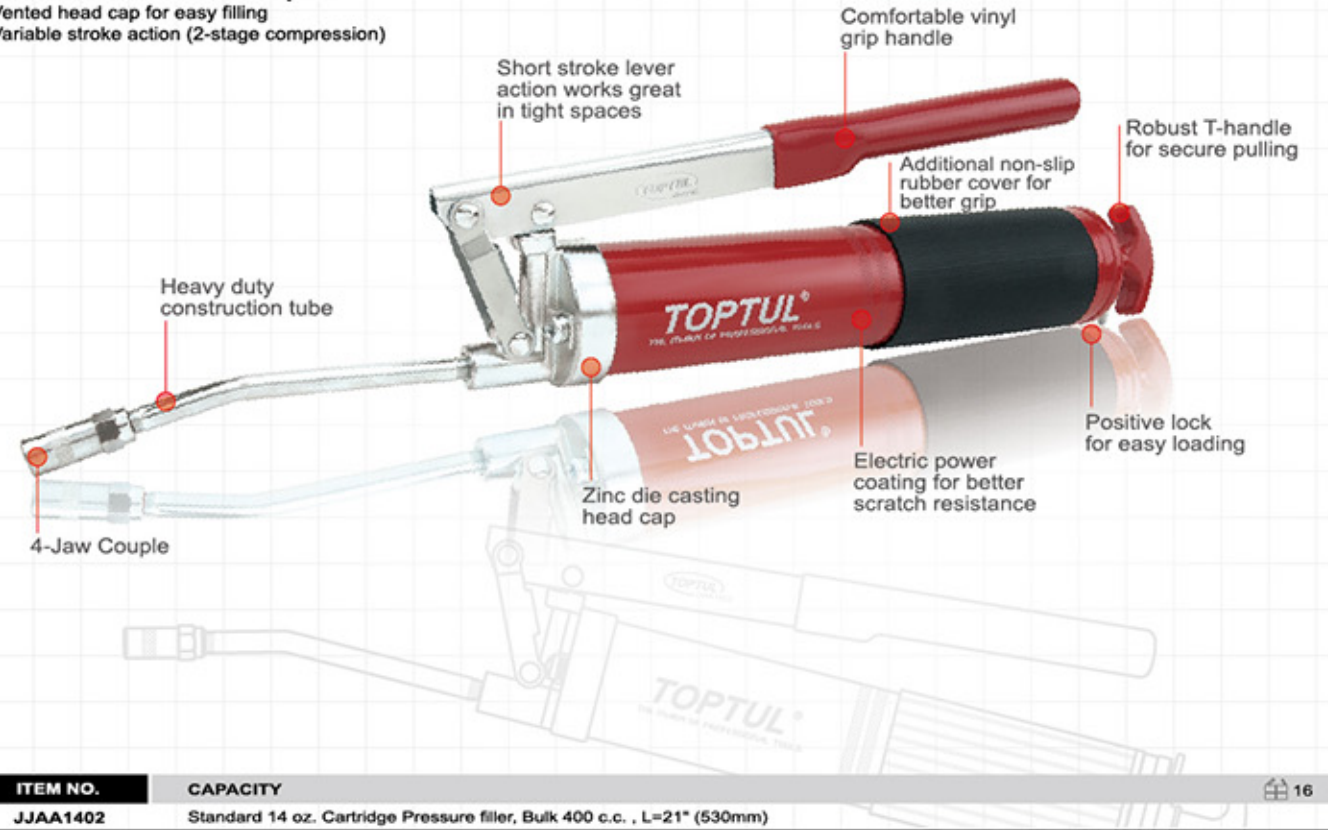

ITEM NO.	CAPACITY	16
JJAA1402	Standard 14 oz. Cartridge Pressure filler, Bulk 400 c.c., L=21" (530mm)	

Lever Type Grease Gun

■ Lever Type Grease Gun (Variable Stroke)
W/ 6" Rigid Tube & 12" Flexible Hose



- Flexible Nylon Grease Gun Hose (ITEM NO: JJAC1212)
Rugged 12 inch long nylon flexible hose attaches to grease gun to reach all fittings faster and easier in tight spots and awkward locations.

- Electric plated finish for long service life
- Short stroke "lever action" for easy use
- Vented head cap for easy filling
- Variable stroke action (2-stage compression)

ITEM NO.	CONTENTS	16 (SET)
JGAE0202	<ul style="list-style-type: none"> ■ JJAA1402 Lever Type Grease Gun (Variable Stroke) W/ 6" Rigid Tube Standard 14 oz. Cartridge, Pressure filler, Bulk 400 c.c., L=21" (530mm) ■ JJAC1212 Flexible Nylon Grease Gun Hose L=12" (300mm) 	

Other Tools

**Piston Grip Grease Gun
W/7" Rigid Tube**



- Electric plated finished for long service life
- Short stroke piston grip action works great in tight spaces
- Two discharge outlets - 90° & 180°
- Vented head cap for easy filling
- Use standard 14 oz. grease cartridge

ITEM NO.	CAPACITY	12
JJBA1402	Standard 14 oz. Cartridge Pressure filler, Bulk 400 c.c., L=14" (360mm)	

**Piston Grip Grease Gun
W/7" Rigid Tube & 12" Flexible Hose**



- Electric plated finished for long service life
- Short stroke piston grip action works great in tight spaces
- Two discharge outlets - 90° & 180°
- Vented head cap for easy filling
- Use standard 14 oz. grease cartridge

ITEM NO.	CONTENTS	12 (SET)
JGAE0203	1 JJBA1402 Piston Grip Grease Gun-W/7" Rigid Tube Standard 14 oz. Cartridge Pressure filler, Bulk 400 c.c., L=14" (360mm)	
	1 JJAC1212 Flexible Nylon Grease Gun Hose L=12" (300mm)	

**Lubrication - Grease Gun
(Lever Type)**



- 4-Jaw Coupler for Better Grip
- Max. Working Pressure: 4,500 PSI (310 BAR)
- Burst Pressure: 10,000 PSI (690 BAR)
- Thread: 1/8 inch x 28PT
- 1 oz. of Grease: per 40 strokes
- Length: Grease Gun W/Rigid Tube and Coupler: 21 inch (530mm)

ITEM NO.	CAPACITY	16
JJAA1440	Standard 14 oz. Cartridge Pressure filler, Bulk 400 c.c., L=21" (530mm)	

Lubrication - Grease Gun



- 4-Jaw Coupler for Better Grip
- Max. Working Pressure: 4,500 PSI (310 BAR)
- Burst Pressure: 10,000 PSI (690 BAR)
- Thread: 1/8 inch x 28PT
- 1 oz. of Grease: per 40 strokes
- Length: Grease Gun W/Rigid Tube and Coupler: 21 inch (530mm)
Flexible Whip Hose - 12 inch (300mm)

ITEM NO.	CONTENTS	16 (SET)
JGAE0201	1 JJAA1440 Lubrication - Grease Gun Standard 14 oz. Cartridge Pressure filler, Bulk 400 c.c., L=21" (530mm)	
	1 JJAC1212 Flexible Nylon Grease Gun Hose L=12" (300mm)	

Flexible Nylon Grease Gun Hose



ITEM NO.	JJAC1212	12
	Rugged 12 inch long flexible hose attaches to grease gun #JJAA1440 to reach all fittings faster and easier in tight spots and awkward locations.	

Oil Suction Gun (Heavy Duty Type)

- Jumbo size high performance oil suction gun
- Chromed steel suction tube with T-bar type plunger
- Particularly useful for removal of oil from gearboxes and differentials
- Include one 9.5" rigid tube and one 11" flexible plastic hose

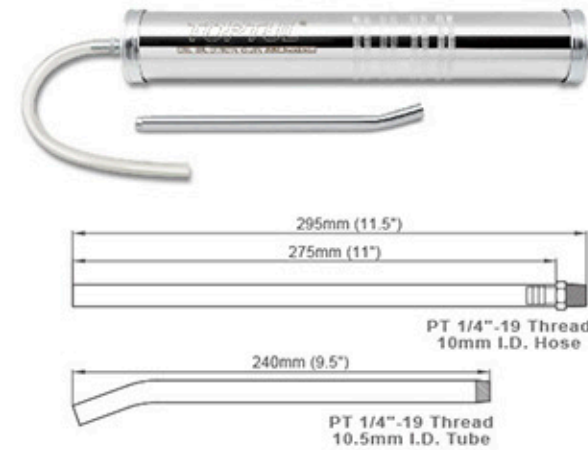

ITEM NO.	CAPACITY	20
JJAZ0135	35 oz. (1000 cc.) L=445mm (17.5")	

Caulking Gun

- 9" Ladder Hook Steel Frame Caulking Gun
- Standard 300ml / 10 oz. cartridge
- Hardened and zinc-coated piston hex steel rod
- Riveted pressure plate & push rod
- Durable die-cast zinc alloy handle and trigger
- Quick release thumb lever
- Built-in seal puncture tool
- Thrust Ratio: 10:1
- Ideal for Latex, Silicone, Adhesives, Sealant, Rubber Compound & Polyurethanes



ITEM NO.	SIZE (inch)	10	30
JJAY0902	9		

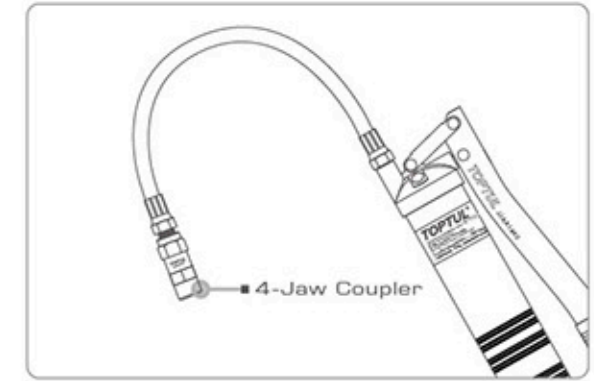

Aluminum Tube Caulking Gun

- 9" Ladder Putter Steel Frame Caulking Gun
- Standard 300ml / 10 oz. cartridge
- Seamless die-cast aluminum alloy tube and durable trigger
- Riveted pressure plate & push rod
- Quick release thumb lever
- Additional eyelet to attach to safety strap
- Thrust Ratio: 13:1
- Ideal for Latex, Silicone, Adhesives, Sealant, Rubber Compound & Polyurethanes



ITEM NO.	SIZE (inch)	5	15
JJAY0904	9		

Revolving Barrel Caulking Gun

- 9" Ladder Hook Steel Frame Caulking Gun
- Standard 300ml / 10 oz. cartridge
- Easy load, revolving open barrel
- Hardened and zinc-coated piston round steel rod
- Durable die-cast aluminum alloy handle and trigger
- Quick release thumb lever
- Additional eyelet to attach to a safety strap
- Thrust Ratio: 13:1
- Ideal for Latex, Silicone, Adhesives, Sealant, Rubber Compound & Polyurethanes



ITEM NO.	SIZE (inch)	5	15
JJAY0903	9		

Other Tools

4PCS Jumbo Pry Bar

- Used for all large prying, levering and positioning heavy duty applications
- Made of square chrome molybdenum alloy steel
- High impact go-through shank with steel cap
- Hardened and sharpened blade tips
- Extra large bi-component plastic PP+TPR material grip handle

CR-MO

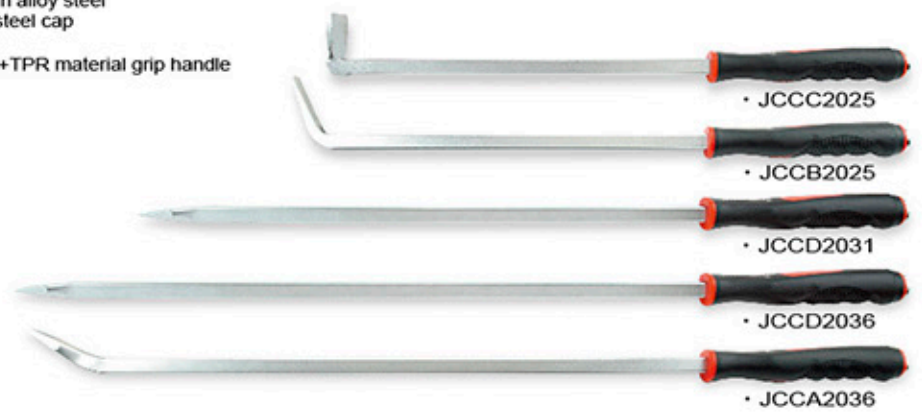

ITEM NO.	TYPE	L(inch)	Hand	Weight
JCCC2025	90 Degree Angle Tip Pry Bar (wide face)	25	2	8
JCCB2025	75 Degree Angle Tip Pry Bar (narrow face)	25	2	8
JCCD2031	Straight Pry Bar (wide face)	31	3	6
JCCD2036	Straight Pry Bar (wide face)	36	3	6
JCCA2036	30 Degree Angle Tip Pry Bar (wide face)	36	3	6

4PCS Pry Bar

- Made of Chrome Vanadium Steel
- Flat and bevelled tips allow application in areas with restricted access
- Solid square blades guarantee high power transmission

CR-V

4PCS Jumbo Pry Bar Set



Black Phosphate Finish

ITEM NO.	SIZE(inch)	Hand	Weight
JCBA0608	8	5	80
JCBA9E12	12	5	30
JCBA1118	18	5	20
JCBA1124	24	5	10

ITEM NO.	CONTENTS	Weight
JGAI0401	1 JCCD2036 Straight Pry Bar - 36" (L) 1 JCCA2036 30 Degree Angle Tip Pry Bar - 36" (L) 1 JCCB2025 75 Degree Angle Tip Pry Bar - 25" (L) 1 JCCC2025 90 Degree Angle Tip Pry Bar - 25" (L)	2 (SET)

BLOW CASE: W1000 x D255 x H75 (mm)

4PCS Mechanic Pry Bar Set

CR-V

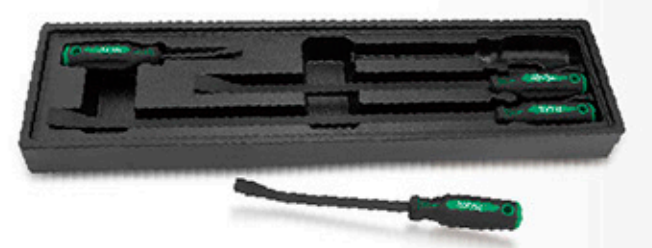

Black Phosphate Finish

ITEM NO.	CONTENTS	Weight
JGAT0402	4 8", 12", 18", 24"	8 (SET)

File Tool



ITEM NO.	TYPE	L(inch)	Hand	Weight
SDBC0821	Half Round File	8	5	60
SDBA0808	Square File	8	5	60
SDBD0808	Round File	8	5	60
SDBB0821	Flat File	8	5	60
SDBE0815	Triangle File	8	5	60

4PCS File Set

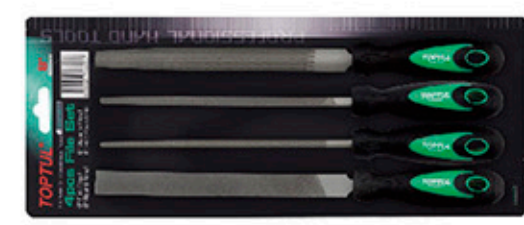

ITEM NO.	CONTENTS	Weight
GBAR0401	1 Square File - 8", Flat File - 8" Half Round File - 8", Round File - 8"	5 (SET)

5PCS File Set



ITEM NO.	CONTENTS	Weight
GPAQ0503	1 SDBC0821 Half Round File - 8" 1 SDBA0808 Square File - 8" 1 SDBD0808 Round File - 8" 1 SDBB0821 Flat File - 8" 1 SDBE0815 Triangle File - 8"	6 (SET)

6PCS Needle File Set

- High quality precision machined needle files
- Suitable for fine abrasion, profile cutting and finishing of common workshop materials
- 4mm diameter, overall length 160mm with 75mm of cutting surface



ITEM NO.	CONTENTS	Weight
GNBA0601	1 SDNA0401 Knife Needle File 1 SDNA0402 Round Needle File 1 SDNA0403 Half Round Needle File 1 SDNA0404 Square Needle File 1 SDNA0405 Triangle Needle File 1 SDNA0406 Flat Needle File	25 (SET)

5PCS Diamond Needle File Set

- High quality precision machined diamond needle files
- Perfect for filing off sharp edges, reshaping cuts or reaming drilled holes
- 4mm diameter, overall length 160mm with 65mm of #150 grit diamond coating surface



ITEM NO.	CONTENTS	Weight
GNBA0501	1 SDNB0402 Round Diamond Needle File 1 SDNB0403 Half Round Diamond Needle File 1 SDNB0404 Square Diamond Needle File 1 SDNB0405 Triangle Diamond Needle File 1 SDNB0406 Flat Diamond Needle File	25 (SET)

TOPTUL
FILE SET SERIES

Telescopic Pipe Cutter



- Model with telescopic advance mechanism and uniform dimensions
- Grooved guide-rollers for cutting flanged tubes and close-to-flare cut
- For cutting cooper and light alloy pipes
- Built-in retractable reamer
- Light zinc alloy body
- High hardened & hard-wearing bearing steel cutting wheel (SUJ2)
- Large adjustment knurled knob
- Overall length: 135mm

ITEM NO.	CUTTING CAPACITY Ø (mm)	L (mm)	Wt (kg)	PKT
SEAA0332	3 - 32 (1/8" - 1-1/4")	135	1	40

Plastic Pipe Cutter

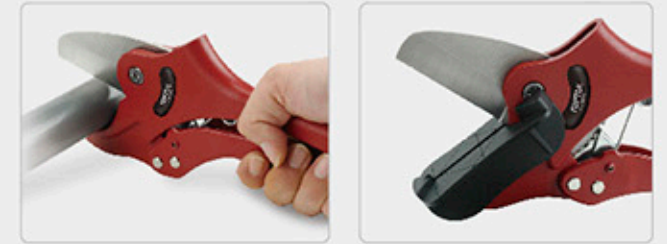

- Ratchet mechanism model for an effortless progressive cutting action
- Light, die-cast aluminum alloy body
- Round jaw design for easy and quick hold of pipe
- Precision ground and heat treated stainless steel blade
- Suitable for cutting PVC, polyethylene, synthetic pipes, rubber hose and various kinds of plastic material pipe or tubing

ITEM NO.	OPEN MAX. CUTTING CAPACITY Ø (mm)	L (mm)	Wt (kg)	PKT
SEAB4224	42 (1-5/8")	240	6	36

Ratchet Pipe Cutter

- Expert Quality, adjustable tubing cutter with handle and hardened steel blade
- Ratchets in 10-Degree increments while cutting 360-Degree around tube
- Robust zinc alloy ratchet mechanism, ideal for confined space applications
- Smooth cutting operation with 2 support rollers
- Exclusive one hand operation
- Plastic housing with large knurled knob
- Cuts copper, aluminum, plastic and stainless steel thin wall tubing
- Spare cutting wheel supplied



ITEM NO.	CUTTING CAPACITY Ø (mm)	L (mm)	Applications	Wt (kg)	PKT
SEAC0828	8 - 28 (5/16" - 1-1/8")	170	Stainless Steel Tube (wall thickness ≤ 2mm) Copper, Aluminum & Plastic Tube (wall thickness ≤ 3mm)	6	36

Ratchet Pipe Cutter

- Expert Quality, adjustable tubing cutter with handle and hardened steel blade
- Ratchets in 6-Degree increments while cutting 360-Degree around tube
- Robust zinc alloy ratchet mechanism, ideal for confined space applications
- Smooth cutting operation with 2 support rollers
- Exclusive one hand operation
- Plastic housing with large knurled knob
- Cuts copper, aluminum, plastic and stainless steel thin wall tubing
- Spare cutting wheel supplied

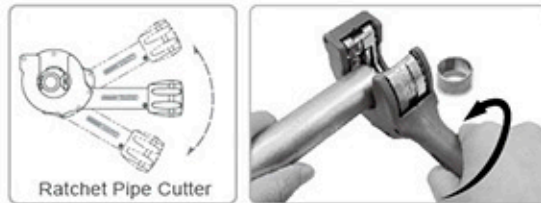

ITEM NO.	CUTTING CAPACITY Ø (mm)	L (mm)	Applications	Wt (kg)	PKT
SEAC2867	28 - 67 (1-1/8" - 2-5/8")	250	Stainless Steel Tube (wall thickness ≤ 2mm) Copper, Aluminum & Plastic Tube (wall thickness ≤ 3mm)	1	12

High Tensile Strength Bolt Cutter

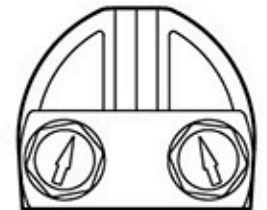

HIGH TENSILE STRENGTH BOLT CUTTER

ITEM NO.	CUTTING CAPACITY Ø (mm)	LENGTH (inch)	Wt (kg)	PKT
SBAB1205	6	12	1	20
SBAB1407	7	14	1	20
SBAB1808	8	18	1	20
SBAB2410	10	24	1	10
SBAB3013	13	30	1	6
SBAB3615	16	36	1	5
SBAB4219	19	42	1	3

BOLT CUTTER CUTTING CAPACITY

Size	Soft Metal	Medium Metal
12"(300mm)	Ø 6mm(1/4")	Ø 4mm(5/32")
14"(350mm)	Ø 7mm(9/32")	Ø 5mm(3/16")
18"(450mm)	Ø 8mm(5/16")	Ø 6mm(1/4")
24"(600mm)	Ø 10mm(3/8")	Ø 8mm(5/16")
30"(750mm)	Ø 13mm(1/2")	Ø 8mm(5/16")
36"(900mm)	Ø 16mm(5/8")	Ø 10mm(3/8")
42"(1120mm)	Ø 19mm(3/4")	Ø 12mm(7/16")

Other Tools

Multi-Purpose Electricians Scissors



- Specially designed for repair service use
- Heavy-duty high carbon Stainless Steel mighty Molybdenum and Vanadium Alloy blades
- Precision hollow-ground and hardened long-lasting cutting edge
- Micro-serration blade design for strong grips on cutting objects
- Extension tang design to increase overall input leverage
- High grade Nylon-made ergonomic modern handles (With 30% Fiberglass)

ITEM NO.	LENGTH (mm)		
SBA0414	138	8	64

Straight Pattern Snips



- All-PURPOSE**
- Meets or exceeds federal specification ANSI/ASME B107.16-1998 and German standard DIN 6438/11.71
 - Drop forged high grade tool steel construction
 - Induction hardened cutting edges HRC 58 - 61

ITEM NO.	CUTTING LENGTH (mm)	L (mm)		
SBAE0808	40	200 (8")	8	48
SBAE1010	51	250 (10")	6	36
SBAE1212	70	300 (12")	6	24

Offset Tin Snips



Green - SBAD0224
Right and Straight Cut



Red - SBAD0124
Left and Straight Cut

- Meets or exceeds federal specification ANSI/ASME B107.16-1998 and German standard DIN 6438/11.71
- Drop forged Chrome-Molybdenum Alloy Steel blades
- Induction hardened cutting edges HRC 60 - 62
- Precision, serrated cutting jaws ensure quality result
- Cuts up to 1.2mm cold rolled steel or 0.7mm AISI-304 stainless steel

Cuts extremely hard metals of hardness of HRC 40 (0.8m/m), such as stainless steel and more.

ITEM NO.	Offset Tin Snips	Cutting Length (mm)	L(mm)		
SBAD0124	Left cut	35	240	6	48
SBAD0224	Right cut	35	240	6	48

Aviation Tin Snips



Green - SBAC0225
Right Cut



Yellow - SBAC0325
Straight cut



Red - SBAC0125
Left Cut

- Meets or exceeds federal specification ANSI/ASME B107.16-1998 and German standard DIN 6438/11.71
- Drop forged Chrome-Molybdenum Alloy Steel blades
- Induction hardened cutting edges HRC 60 - 62
- Precision, serrated cutting jaws ensure quality result
- Cuts up to 1.2mm cold rolled steel or 0.7mm AISI-304 stainless steel

Cuts extremely hard metals of hardness of HRC 40 (0.6m/m), such as stainless steel and more.

ITEM NO.	Aviation Tin Snips	Cutting Length (mm)	L(mm)		
SBAC0125	Left cut	35	248	6	48
SBAC0225	Right cut	35	248	6	48
SBAC0325	Straight cut	35	250	6	48

Multi-Purpose Hacksaw

- Multi-angle blade adjustment - 45°, 90°, 135° & 180°
- Fully adjustable blade tension
- High blade tension for straight accurate cut (including flush cut)
- Two-hand grip for comfort and easy operation
- Quick and easy blade change
- ABS+TPR plastic ergonomic designed & anti-slip handle
- Shatterproof premium quality blade for excellent cutting performance
- Handy blade storage in tubular frame (stored up to 3pcs spare blade)
- Ideal for cutting metal and aluminum tube, sheets and hard plastics
- Blade: 300mm (12" / 24 TPI), 0.6mm (T)



ITEM NO.	BLADE SIZE (inch)		
SAAA3051	12	12	24



Adjustable Tension Knob



To loosen the knob for multi-angle adjustment



Replace the New Blade



Press the Button to Pull the Metal Tube (Easy access to spare blade storage)

Heavy Duty Hacksaw

- Robust Die Cast Aluminum Frame
- Easy And Smooth Blade Tension Adjustments
- -45° & 90° Blade Cutting Angle
- Shatterproof Premium Quality Blade



ITEM NO.	BLADE SIZE (inch)		
SAAA3013	12	6	24

Deluxe Mini Hacksaw

- Industrial grade high strength hacksaw
- Premium quality blade
- 6 blade angle settings
- TPR material grip handle

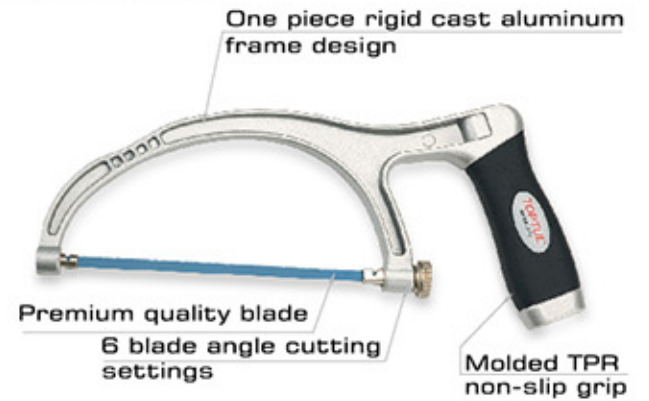

ITEM NO.	BLADE SIZE (inch)		
SAAA1527	6	12	72

High Speed Steel Hacksaw Blades



- Attaches To Heavy Duty Hacksaw #SAAA3013 / #SAAA3051

ITEM NO.	BLADE SIZE (inch)		
SAAB2430	12	100	800

High Speed Steel Hacksaw Blades



- Attaches To Deluxe Mini Hacksaw #SAAA1527

ITEM NO.	BLADE SIZE (inch)		
SAAB2415	6	100	800

Other Tools

Utility Knife

- (W/Spare Blade)
- Snap-off blades, 8 sharp points snap segment blades
- Premium quality tool steel blade (SK5)
- Stainless steel blade guide for strength and rust resistance
- Rugged ABS housing
- Blade lock knob
- Blade Dimension: (W)18mm x (L)100mm (0.5mm thick)



ITEM NO.	LENGTH (mm)	Weight (g)	Volume (cm³)
SCAD1817	165	12	240

Auto Reload Utility Knife

- (W/Spare Blade)
- Automatically reloading snap-off blades
- Premium quality tool steel blade (SK2)
- Stainless steel blade guide
- Ergonomic bi-component ABS+TPR anti-slip plastic handle
- Blade lock knob
- 4-blade quick change cartridge
- Blade Dimension: (W)18mm x (L)100mm (0.5mm thick)
- Includes 4 blades



ITEM NO.	LENGTH (mm)	Weight (g)	Volume (cm³)
SCAC1817	165	12	72

Heavy Duty Utility Knife With Spare Blade

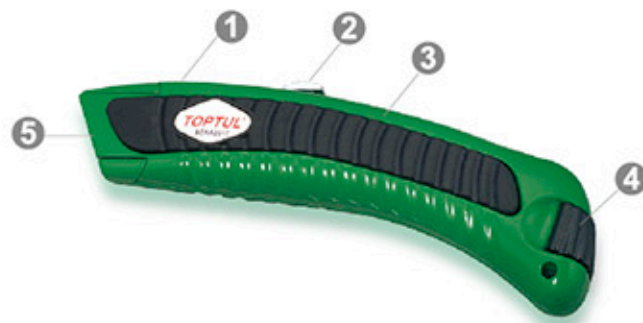

- Curved Handle Design With Slip-Resistant Grip For Comfort And Ease Of Use
- Retractable Blade Locks In 4 Positions
- Unique Comfort Texture For Firm And Strong Grip
- Intergraded Smart Opening Trigger In Design. No Tools Required For Quick Blade Changes
- Safe Overlapping Knife Design Surrounds Blade For Heavy Duty Cutting

ITEM NO.	LENGTH (mm)	Weight (g)	Volume (cm³)
SCAA2017	165	12	72

10PCS Replacement Utility Knife Spare Blade Set



- Attaches To Auto Reload Utility Knife #SCAC1817 / #SCAD1817
 - Supplied in 10-piece spare blade cartridge
- ITEM NO. SCAB18A0** 24 (SET)
- Blade Dimension: (W)18mm x (L)100mm
 - Blade Thickness: 0.5 mm

10PCS Utility Knife Blade Set



- Attaches To Heavy Duty Utility Knife #SCAA2017
- ITEM NO. SCAB2060** 25 (SET)
- Blade Dimension: (W)20mm x (L)60mm
 - Blade Thickness: 0.6 mm

H.S.S. Bi-Metal Hole Saw

- INDUSTRIAL QUALITY**
- High speed steel cutting edge
 - 4/6T variable pitch rake teeth
 - Bi-metal construction for toughness and long service life
 - Cut through various types of steel, stainless steel, brass, aluminum, plastic, hardwood, plywood and other materials
 - Cutting Depth: 47mm



ITEM NO.	Cutting Diameter Ø (mm)	L (mm)	Weight (g)	Volume (cm³)
SAAC4714	14	66	1	150
SAAC4716	16	66	1	150
SAAC4717	17	60	1	150
SAAC4719	19	60	1	150
SAAC4720	20	60	1	150
SAAC4722	22	60	1	100
SAAC4725	25	60	1	100
SAAC4727	27	60	1	100
SAAC4729	29	60	1	100
SAAC4735	35	60	1	100
SAAC4737	37	60	1	100
SAAC4738	38	60	1	100
SAAC4741	41	60	1	100
SAAC4744	44	53	1	100
SAAC4751	51	53	1	100
SAAC4754	54	53	1	100
SAAC4757	57	53	1	100
SAAC4760	60	53	1	100
SAAC4762	62	53	1	100
SAAC4764	64	53	1	100
SAAC4765	65	53	1	100
SAAC4776	76	53	1	50
SAAC4789	89	53	1	50
SAAC4792	92	53	1	50

Bi-Metal Hole Saw Arbor (14 - 30MM)

- Hole saw arbor with 1/4" diameter high speed steel (HSS) pilot drill
- Hex shank improves the chuck grip
- Hardened mandrel for long thread life
- Removable pilot drill for easy replacement
- Fit bi-metal hole saw size 14 to 30mm (9/16" to 1-3/16")



ITEM NO.	Applicable Diameter (For Bi-Metal Hole Saw) Ø(mm)	Hex Shank (mm)	Chuck Size (inch)	Screw Thread	Weight (g)	Volume (cm³)
SAAD1401	14 - 30	11 (7/16")	1/2	1/2"-20 UNF	1	50



Bi-Metal Hole Saw Arbor (32 - 210MM)

- Hole saw arbor with 1/4" diameter high speed steel (HSS) pilot drill
- Hex shank improves the chuck grip
- Hardened mandrel for long thread life
- Pin lock the hole saw to prevent over-tightening
- Removable pilot drill for easy replacement
- Fit bi-metal hole saw size 32 - 210mm (1-1/4" to 8-9/32")



ITEM NO.	Applicable Diameter (For Bi-Metal Hole Saw) Ø(mm)	Hex Shank (mm)	Chuck Size (inch)	Screw Thread	Weight (g)	Volume (cm³)
SAAD1402	32 - 210	11 (7/16")	1/2	5/8"-18 UNF	1	50

Other Tools

3-Claw Pick-Up Tool

- Retractable 3-clawed pincers with push-button control
- Flexible shaft holds shape to reach around obstacles
- Pick up non-magnetic objects such as electronic components
- Bi-component plastic handle grip

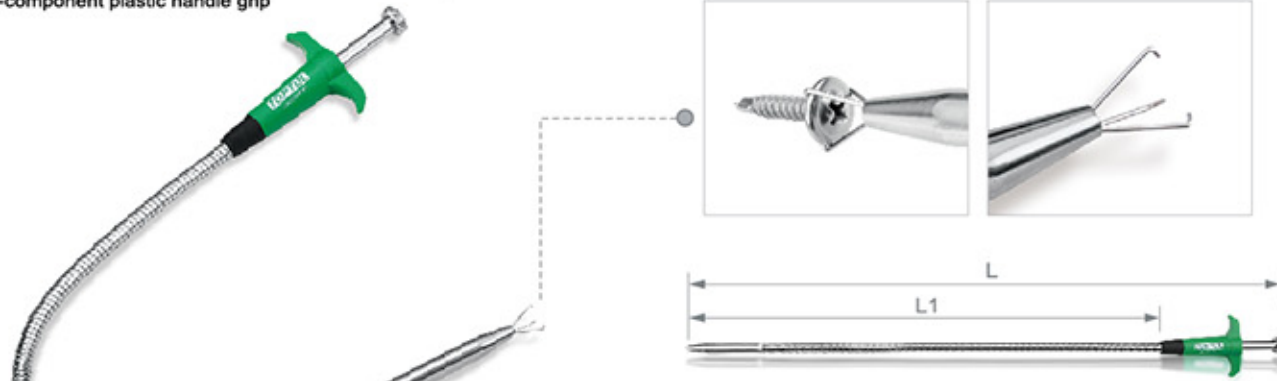

ITEM NO.	Max. Claw Opening Capacity Ø(mm)	L1(mm)	L(mm)	Weight	Length
JJCG0350	32	395	500	10	40
JJCG0360	32	495	600	10	40

Telescoping Magnetic Pick-Up Tool



ITEM NO.	MAGNET(lbs)	LENGTH(mm)	Weight	Length
JJAG3E68	3.5 (1.6kgs)	417 - 680	24	72

Telescoping Magnetic Pick-Up Tool



- Extends From 130 - 640mm Long
- Telescoping Shaft Lifting Capacity 3.5 LBS

ITEM NO.	MAGNET(lbs)	LENGTH(mm)	Weight	Length
JJAG3E63	3.5 (1.6kgs)	130 - 640	24	384

Telescoping Inspection Mirror



ITEM NO.	MIRROR DIAMETER	LENGTH(mm)	Weight	Length
JJAM0242	57mm	283 - 420	25	100

Telescoping Insepction Mirror



ITEM NO.	MIRROR SIZE (W) x (L)	LENGTH(mm)	Weight	Length
JJAM0144	50 x 90mm	307 - 443	25	100

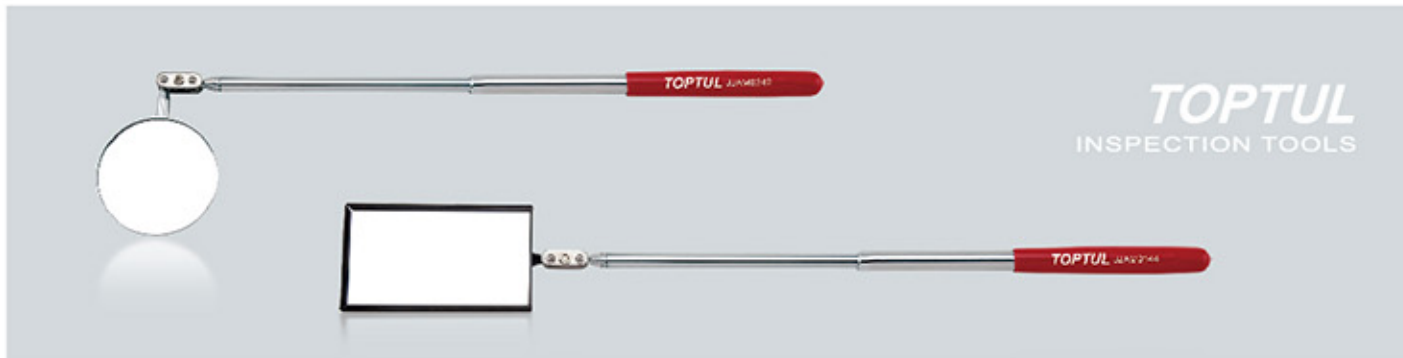

Magnetic Flexible Handle

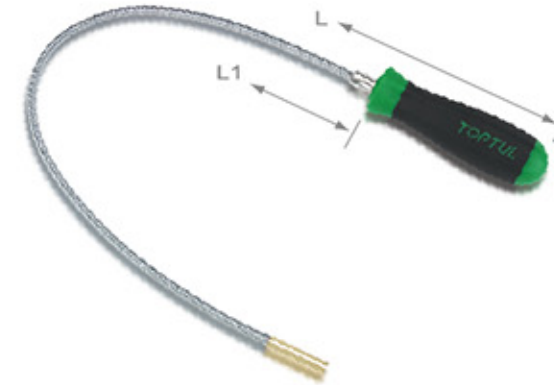

- Flexible shaft holds shape and can retrieve at hard-to-reach angles and around obstructions

ITEM NO.	L1(mm)	L(mm)	Weight	Length
JJAD0512	305 (12")	420 (16-1/2")	10	60
JJAD0518	457 (18")	572 (22-1/2")	10	60

Magnetic Flexible Handle

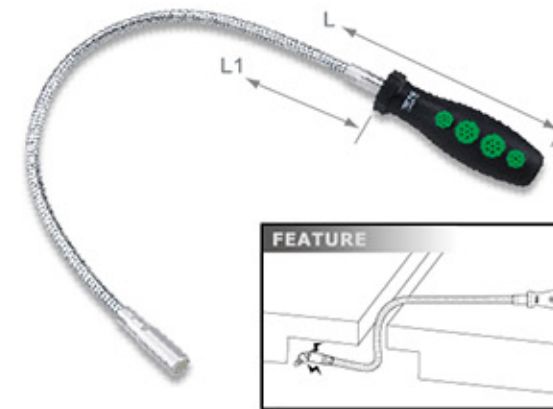

- Strong shaft bends and holds in all position
- Magnetic capacity: 1.6kgs (3.5lbs)

ITEM NO.	L1(mm)	L(mm)	Weight	Length
JJAD1423	475 (19")	585	12	48

Magnetic Trays



ITEM NO.	SIZE(mm)	Weight	Length
JJAF1506	Ø150 x H42	1	30
JJAF2414	L240 x W140 x H42	1	20

Measuring Tape



- Easy Access, Sliding Thumb Lock
- Nylon Coated Steel Tape for Maximum Corrosion Protection & Wear Resistance
- High Impact ABS Case with Rubber Protected
- Double Riveted End Hook for Lasting Durability
- Stop Button and Automatic Tape Rewind
- Shock-Absorbing Blade Return Bumper
- Dual Scale Reading in both Metric and Imperial

ITEM NO.	SIZE	TAPE WIDTH(inch)	Weight	Length
IAAA0003	3M/10FT	3/4" (19mm)	6	72
IAAA0005	5M/16FT	3/4" (19mm)	12	72

Measuring Tape

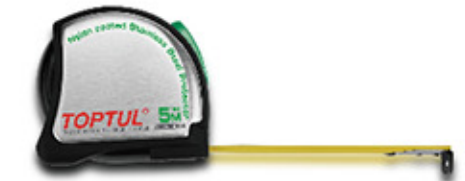

- Easy Access, Sliding Thumb Lock
- High Impact Stainless Steel Case With Nylon Protected
- Double Riveted End Hook For Lasting Durability
- Shock-Absorbing Blade Return Bumper

ITEM NO.	SIZE	TAPE WIDTH(inch)	Weight	Length
IAAB1905	5M/16FT	3/4" (19mm)	12	72

12PCS

Measuring Tape Set W/Display Box



ITEM NO.	CONTENTS	Weight	Length
IAAB2508S	12 8M/27FT x 25mm (1")		4

Other Tools

130PCS

Professional Threaded Coil-Insert Repair Kit

- Ideal for repairing and restoring damaged threads, suitable for machine construction, engine repair and other automotive applications
- For most commonly used metric bolt sizes
- Thread insert sizes M5, M6, M8, M10 and M12
- Each size includes stainless steel screw coils, high speed steel thread tap & twist drill, installation tools and pin breaking tools

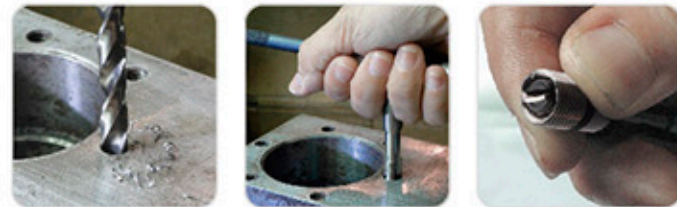

1. Drill out damaged thread using correctly sized drill bit
2. Tap re-drilled hole using tap
3. Load coiled insert into applicator



4. Screw coil into casting
5. Using pin breaking tool, break off pin on insert
6. Thread is repaired and ready to use

ITEM NO. CONTENTS 8 (SET)

- JGAD130A** 110 **Stainless Steel Screw Coil Inserts**
- 25PCS- M5x0.8mmx1.5D (L=7.5mm)
 - 25PCS- M6x1.0mmx1.5D (L=9.0mm)
 - 25PCS- M8x1.25mmx1.5D (L=12.0mm)
 - 25PCS- M10x1.5mmx1.5D (L=15.0mm)
 - 10PCS- M12x1.75mmx1.5D (L=18.0mm)
- Twist Drills**
- M5 (Ø5.2mm), M6 (Ø6.3mm), M8 (Ø8.3mm), M10 (Ø10.4mm), M12 (Ø12.4mm)
- Thread Taps**
- M5x0.8mm, M6x1.0mm, M8x1.25mm, M10x1.5mm, M12x1.75mm
- Installation Tools**
- M5, M6, M8, M10, M12
- Pin Breaking Tools**
- M5, M6, M8, M10, M12

METAL CASE: W357 x D221 x H28 (mm)

3PCS

Damaged Screw Remover Set

- Removes damaged Phillips, Slotted, Star and Square screws and etc
- Special hardened steel bits for secure bite on damaged fasteners
- 1/4" hex shank fits drill, sockets and screwdrivers
- Material: Ball Bearing Steel (SUJ2)

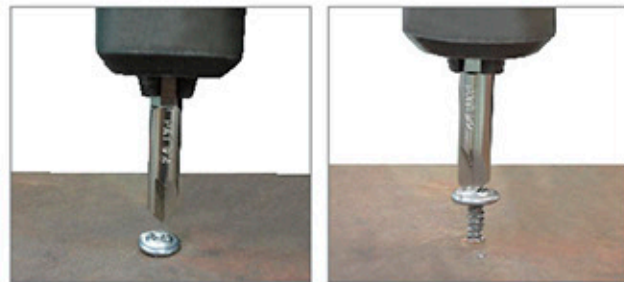

Screw extractor bit plows into the head of a damaged screw and turn it out quickly and easily!

ITEM NO. CONTENTS 10 (SET)

JGAW0301 #1, #2, #3

Spot Weld Drill Bit



- Special drill bit for the removal of spot welds
- Flat Ground for strength
- Self centering tip minimizes walking
- Made of high speed steel (HSS) with 8% Cobalt
- Titanium coated hardened tip

ITEM NO.	SIZE(mm)	L1(mm)	L(mm)	Weight	Count
JJAX0817	Ø 8	17	45	18	216
JJAX0821	Ø 8	21	80	16	192

5PCS

Screw Extractor Set



ITEM NO. CONTENTS 25 (SET)

JGAW0501 5/16", 1/4", 5/16", 7/16", 9/16"

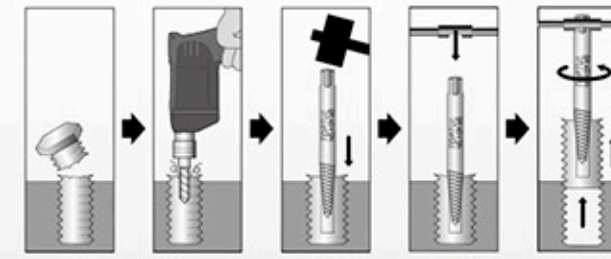

To use, a small hole needs to be drilled in the centre of the rogue screw and the correct sized extractor inserted. The extractors are threaded in the opposite direction to conventional screw threads. When the extractor is tightened in an anti-clockwise direction, it begins to loosen the screw.

40PCS

Tap & Die Set



ITEM NO. CONTENTS 10 (SET)

- JGAI4001** 34 **Tap & Die**
- M3x0.5, M3x0.6, M4x0.7, M4x0.75, M5x0.8, M5x0.9, M6x0.75, M6x1.0, M7x0.75, M7x1.0, M8x1.0, M8x1.25, M10x1.25, M10x1.5, M12x1.25, M12x1.5, 1/8 NPT-27
 - Die Stock Handle** 1" / 25mm O.D.
 - Tap Wrench** M3 - M12
 - T-Type Tap Wrench** M3 - M6
 - Screw Pitch Gauge** 0.5, 0.6, 0.7, 0.75, 0.8, 0.9, 1.0, 1.25, 1.5, 1.75, 27, 28
 - Slotted Screwdriver** 0.6x3mm L=93mm
 - Blow Case** W300xD230xH53mm

BLOW CASE: W300 x D230 x H53 (mm)

5PCS

Screw Extractor Set



ITEM NO. CONTENTS 25 (SET)

JGAW0502 7/64", 9/64", 5/32", 1/4", 19/64"

Nut Splitter



ITEM NO.	SIZE(mm)	L(mm)	Weight	Count
DAAX1A12	9 - 12	76	20	240
DAAX1A16	12 - 16	94	10	120
DAAX1A22	16 - 22	124	5	40
DAAX1A27	22 - 27	150	2	32

4PCS

Nut Splitter Set



- For the safe removal of corroded or damaged nuts without damaging bolt threads
- Drop forged steel body hardened and tempered with chrome plated
- Threaded splitting pin manufactured from chrome vanadium steel with black phosphate finish
- Packed in blow molded case

ITEM NO. CONTENTS 10 (SET)

GAAI0402 4 **DAAX1A12-1A27**
9 - 12 mm, 12 - 16 mm, 16 - 22 mm, 22 - 27 mm

BLOW CASE: W260 x D170 x H60 (mm)

Other Tools

4PCS Tweezers



- Made of Stainless Steel
- Precision tweezers for working on fine installation and assembly work

ITEM NO.	LENGTH (mm)	Hand	Weight (g)
JJAV0312	115	30	480
JJAV0212	120	30	480
JJAV0112	116	30	480
JJAV0411	112	30	480

4PCS Tweezers Set

Tweezers Set



ITEM NO.	JGAA0401	Weight (g)	Quantity
		20	(SET)

6PCS 1/2" DR. Impact Driver Set

1/2" DR. Impact Driver Set



ITEM NO.	CONTENTS	Weight (g)	Quantity
GAAD0602	<ul style="list-style-type: none"> 1 FIAA1615 1/2" Dr. Impact Driver - 145mm (L) 1 FTAB1610 Quick Change Bit Holder 1/2" Dr. x 5/16" (H) - 38mm (L) 2 FSAC1008 & 1010 5/16" Hex Shank Slotted Insert Bits 1.2 x 8 mm & 1.6 x 10 mm - 36mm (L) 2 FSBC1002 & 1003 5/16" Hex Shank Phillips Insert Bits PH2 & PH3 - 36mm (L) 	20	(SET)

METAL CASE: W196 x D70 x H47 (mm)

3 Row Stainless Steel Wire Scratch Brush

- 3 rows of rustproof stainless steel wire
- Kiln-dried hardwood for maximum tuft retention
- Angle pattern curved handle, hang-up hole for convenient storage
- Ideal for removing rust, corrosion, paint and all general surface cleaning
- Fill Pattern: 3 Rows of 15
- Bristle Length: 25mm
- Brush Dimension: (L)290 x (W)27 x (H)46mm



ITEM NO.	LENGTH (mm)	Weight (g)	Quantity
NBAA0315	290	12	72

Brake Calliper Brush

- 2 rows of rustproof stainless steel wire
- Slim body design
- Hang-up hole for convenient storage
- Ideal for removing dust, rust from brake calliper and all general surface cleaning
- Fill Pattern: 2 Rows
- Bristle Length: 27mm
- Brush Dimension: (L)219 x (W)13.5 x (H)48mm



ITEM NO.	LENGTH (mm)	Weight (g)	Quantity
NBBA0212	219	10	60

8PCS 1/2" DR. Impact Driver Set

1/2" DR. Impact Driver Set



ITEM NO.	CONTENTS	Weight (g)	Quantity
GAAD0808	<ul style="list-style-type: none"> 1 FIAA1615 1/2" Dr. Impact Driver - 145mm (L) 1 FTAB1610 Quick Change Bit Holder 1/2" Dr. x 5/16" (H) - 38mm (L) 2 FSAC1008 & 1010 5/16" Hex Shank Slotted Insert Bits 1.2 x 8 mm & 1.6 x 10 mm - 36mm (L) 2 FSBC1002 & 1003 5/16" Hex Shank Phillips Insert Bits PH2 & PH3 - 36mm (L) 2 FSBD1002 & 1003 5/16" Hex Shank Phillips Insert Bits PH2 & PH3 - 80mm (L) 	20	(SET)

METAL CASE: W196 x D70 x H47 (mm)

12PCS 5W COB LED Pen Light Set W/Display Box

- Powerful lighting inspection lamp with 5W COB LED
- Rugged ABS material housing
- 450 Lux at 0.5 meter
- Pocket clip and bottom magnet for hands-free use
- Powered by 3 x AAA batteries (not included)
- Dimensions = L165 x W 25 x H 30 (mm)
- Content: 12 pcs per set



ITEM NO.	CONTENTS	Weight (g)	Quantity
JJAT0405S	12 5W COB LED Pen Light Dimensions = L165 x W25 x H30 (mm)	12	(SET)

20PCS Metric Feeler Gauge (Tapered Tips)

- 20 Blades made of hardened Spring Steel
- Thumb notch design of blade protector to aid in removal of blades
- Chrome plated steel protector with locking knurl nut



- CONTENTS: 0.05, 0.10, 0.15, 0.20, 0.25, 0.30, 0.35, 0.40, 0.45, 0.50, 0.55, 0.60, 0.65, 0.70, 0.75, 0.80, 0.85, 0.90, 0.95, 1.00mm

ITEM NO.	Number of Blades	Blade Length	Blade Width	Blade Thickness Range	Weight (g)	Quantity
ICAA0020	20	100mm	10mm	0.05 - 1.00mm	50	200

Stainless Steel Vernier Caliper

- Made of fully hardened stainless steel
- Accuracy: ±0.02 mm
- Graduations: 0.02 mm / 0.001 inch
- Measuring bar in both metric and imperial measurement
- Easy to read clear black engraved graduations
- For inside, outside, step and depth measurements
- Lock screw for sliding jaw
- Supplied in plastic case

ITEM NO.	Measuring Range (mm)	A (mm)	L (mm)	Weight (g)	Quantity
IACA0150	0 - 150	40	235	1	20

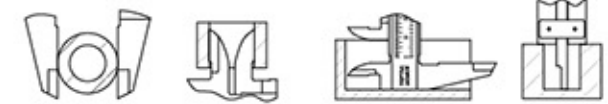
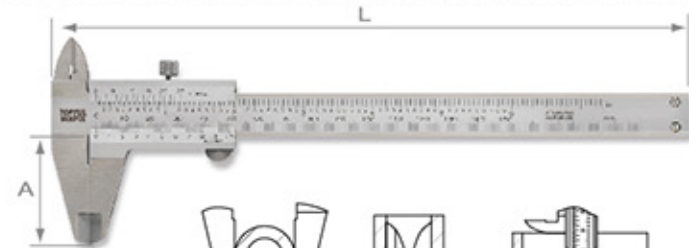

Outside Measurement Inside Measurement Step Measurement Depth Measurement

Angel Nozzle Air Blow Gun

- Ideal for cleaning and removing swarf or dust during assembly
- Angled nozzle enable to reach into tight places
- Steel nozzle with non-slip handle
- Working Pressure: 70 - 120 PSI / 5.0 - 8.0 kgs
- Max Pressure: 160 PSI / 11 kgs
- Sound Pressure: 85 - 90 dB
- Air Consumption (90 PSI): 1/4" Hose - 9 CFM (250 l/min)



ITEM NO.	INLET (inch)	TUBE LENGTH (inch)	Weight (g)	Quantity
KAGA0204	1/4	4	30	60
KAGA0210	1/4	10	25	50

26PCS Inch Feeler Gauge (Rounded Tips)

- 26 Blades made of hardened Spring Steel
- Dual marked blades for both imperial and metric sizes
- Thumb notch design of blade protector to aid in removal of blades
- Chrome plated steel protector with locking knurl nut



- CONTENTS: 0.0015", 0.002", 0.0025", 0.003", 0.004", 0.005", 0.006", 0.007", 0.008", 0.009", 0.010", 0.011", 0.012", 0.013", 0.014", 0.015", 0.016", 0.017", 0.018", 0.019", 0.020", 0.021", 0.022", 0.023", 0.024", 0.025"

ITEM NO.	Number of Blades	Blade Length	Blade Width	Blade Thickness Range	Weight (g)	Quantity
ICBA1026	26	3-1/2" (90mm)	1/2" (12.7mm)	0.0015" - 0.025" (0.04 - 0.63mm)	50	200