

Strut Nut Socket

CR-MO

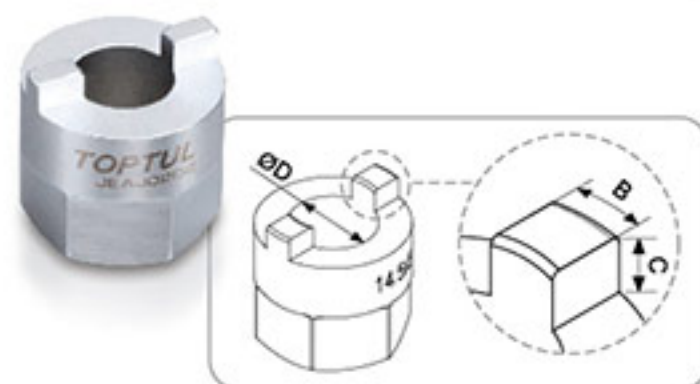

- Made of heat treated and tempered Chrome Molybdenum Steel (CR-MO)
- Suitable for the removal and installation of top shock retaining nut
- Use with 22mm (7/8") spanner

ITEM NO.	SIZE (mm)	B (mm)	C (mm)	ØD (mm)	L (mm)	Applicable	20	160
JEAJ0201	10.5x3.5	3.5	4	10.5	25	VW Golf rear axle	20	160
JEAJ0202	12.5x3.5	3.5	4	12.5	25	VW Polo front axle	20	160
JEAJ0203	14.5x5	5	4	14.5	25	Audi 80, Skoda, Seat, VW Polo / Golf / Passat	20	160
JEAJ0204	14.5x3	3	4	14.5	25	Austin Maestro	20	160
JEAJ0205	14x2.5	2.5	1.5	14	28.5	Mercedes-Benz W203 (C-class) / W209 (CLK)	20	160

3PCS

Strut Nut Socket Set (For VAG)

CR-MO



- Suitable for the removal and installation of top shock retaining nut
- Application: Suitable for most Audi, Seat, Skoda, VW vehicles

ITEM NO.	CONTENTS	20	120
JGAR0303	1 JEAJ0201 Strut Nut Socket Internal Ø10.5mm with 3.5mm Pin		
	1 JEAJ0202 Strut Nut Socket Internal Ø12.5mm with 3.5mm Pin	20	120
	1 JEAJ0203 Strut Nut Socket Internal Ø14.5mm with 5.0mm Pin		

Strut Nut Socket

CR-MO



- Suitable for the removal and installation of top shock retaining nut
- Location pegs fit into slots cut in the retaining ring and allow hex key access through the center for release/adjustment of the shock
- Use with 22mm (7/8") spanner
- Material: Heat treated and tempered Chrome Molybdenum Steel (CR-MO)
- Application: Suitable for most VW, Audi vehicles

ITEM NO.	SIZE (mm)	B (mm)	C (mm)	ØD (mm)	L (mm)	Applicable	6	144
JEAJ0122	15x3.6	4.8	3.6	15	44	Most VW, Audi vehicles	6	144

20PCS

Universal Shock Absorber Strut Nut Tool Kit

- A comprehensive set includes various shock absorber sockets and tools to remove and install turnbuckle & adjust the tension on shock absorber for most vehicles
- Application: VW, Audi, Austin, Mercedes-Benz, Honda, Fiat, Seat, Ford, Rover, Opel, Peugeot, Renault, Citroën, Chrysler, Volvo, Nissan, BMW and etc.



ITEM NO. GZC2008 5 (SET)

ITEM NO.	CONTENTS	5 (SET)
1 JEAJ0204	Strut Nut Socket (for Austin Maestro) Internal Ø14.5mm with 3mm Pin	
1 JEAJ0205	Strut Nut Socket (for Mercedes-Benz W203 (C-class) / W209 (CLK)) Internal Ø14mm with 2.5mm Pin	
4 JEBJ0117-0124	Special Long Reach Sockets 17, 18, 19, 21, 22, 24mm	
4 JEAJ015B-0108	10mm Hex Shank Internal Slotted Insert Bits 5.2, 6, 7, 8mm (L=92mm)	
1 JEAJ0211	10mm Hex Shank Female Hexagon Bit Socket 11mm (L=92mm)	
2 JEAJ0306 & 0307	10mm Hex Shank Male Hexagon Insert Bits 6 & 7mm (L=100mm)	
1 JEAJ0412	10mm Hex Shank Spline Insert Bit M12 (L=100mm)	
1 JEAJ0550	10mm Hex Shank Star Insert Bit T50 (L=100mm)	
3 AOAF1010-2222	72 Teeth Pro-Series Ratchet Combination Wrenches 10, 19, 22mm	

PLASTIC BOX: W373 x D289 x H56 (mm)

20PCS Universal Shock Absorber Strut Nut Tool Kit

KIT CONTENT

Part No.	Size	Description & Application
JEAJ0204	14.5x3mm	Strut Nut Socket Austin Maestro
JEAJ0205	14x2.5mm	Strut Nut Socket Mercedes-Benz W203 (C-class) / W209 (CLK)
JEBJ0117	17mm	Special Long Reach Socket Ford, VW, Audi, Seat, Fiat
JEBJ0118	18mm	Special Long Reach Socket Ford, VW, Audi, Seat, Rover, Opel, Peugeot, Renault, Japanese Cars
JEBJ0119	19mm	Special Long Reach Socket VW, Audi, Seat, Citroën, Fiat, Opel, Peugeot, Toyota
JEBJ0121	21mm	Special Long Reach Socket Mercedes-Benz W203, Chrysler, VW, Audi, Japanese Cars, Ford
JEBJ0122	22mm	Special Long Reach Socket VW, Audi, Seat, Citroën, Fiat, Opel, Peugeot, Renault, BMW
JEBJ0124	24mm	Special Long Reach Socket Volvo
JEAJ015B	5.2mm	10mm Hex Shank Internal Slotted Insert Bit VW, Audi, Nissan
JEAJ0106	6mm	10mm Hex Shank Internal Slotted Insert Bit VW, Audi, Renault
JEAJ0107	7mm	10mm Hex Shank Internal Slotted Insert Bit VW, Audi, Seat, Fiat
JEAJ0108	8mm	10mm Hex Shank Internal Slotted Insert Bit Seat, Fiat
JEAJ0211	11mm	10mm Hex Shank Female Hexagon Bit Socket Japanese Cars
JEAJ0306	6mm	10mm Hex Shank Male Hexagon Insert Bit Seat, Fiat, Citroën, Peugeot, Ford, Opel, Renault, Japanese Cars, BMW
JEAJ0307	7mm	10mm Hex Shank Male Hexagon Insert Bit VW, Audi, Seat, Fiat, Citroën, Peugeot, Mercedes-Benz W203, Renault
JEAJ0412	M12	10mm Hex Shank Spline Insert Bit Opel, Vauxhall
JEAJ0550	T50	10mm Hex Shank Star Insert Bit Nissan, Ford
AOAF1010	10mm	72 Teeth Pro-Series Ratchet Combination Wrenches
AOAF1919	19mm	
AOAF2222	22mm	

KIT CONTENT

Disc Brake Piston Spreader



- Chemically blacken steel spreader plates
- Fits in brake caliper to push back pistons for new brake pads installation
- For installing pads on most domestic and import cars and light trucks
- Maximum pusher width: 70mm (2-3/4")

ITEM NO.	CAPACITY (mm)	Hand	Box
JEAF0107	0 - 70 (0 - 2-3/4")	1	18

Wheel Balancing Weight Pliers with Invisible Spring



- Special tool for balancing automotive tires and wheels; installs, removes, trims, levers, hammers and tightens all type of click-on wheel weights

ITEM NO.	LENGTH (mm)	Hand	Box
JEAA1010	250 (10")	10	40

Tire Lever



- Tempered drop forged steel with one piece quality steel construction
- Suitable for levering tire on/off car or motorbike rims

ITEM NO.	LENGTH (mm)	Hand	Box
JCAB2208	200 (8")	10	80
JCAB2312	300 (12")	10	60
JCAB2415	380 (15")	10	40
JCAB2821	530 (21")	10	20

Brake Spring Pliers

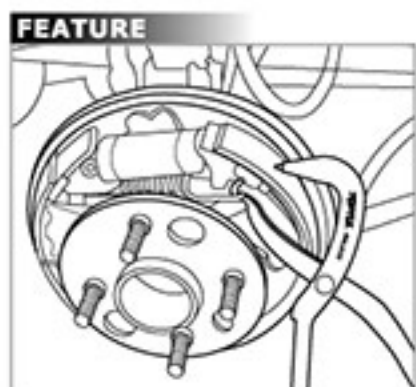

- Use to remove and install shoe return springs on most drum brakes
- Special socket end design removes spring from anchor stud, notched end installs spring on anchor

ITEM NO.	LENGTH (mm)	Hand	Box
JDAL0133	325 (12-3/4")	6	48

Brake Spring Pliers

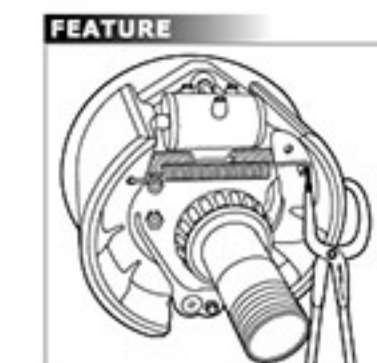

- Use to remove and install brake shoe retain springs
- Large jaw opening allows servicing of wider brake shoes
- Robust structure design to work on of medium-duty and heavy-duty drum brakes
- Extra long knurled handles provide extra leverage for the toughest jobs
- With replaceable spring hooks

ITEM NO.	LENGTH (mm)	Hand	Box
JDAL0452	520 (20-1/2")	3	12

Truck Tire Lever



- Made of drop forged Chrome Molybdenum Alloy Steel
- Suitable for the removal and installation of tubeless truck tires
- Special designed to ease the process of mount and demount tires
- Fine tapered and ground ends for easier use and to lessen the likelihood of damage to tires
- Optimal length for greater leverage

ITEM NO.	LENGTH (mm)	DIAMETER (mm)	Hand	Box
JCEH2237	940 (37")	22	1	5

Truck Tire Lever



- Made of drop forged Chrome Vanadium Alloy Steel
- Suitable for the removal and installation of tubeless truck tires & tractor tires
- Heavy duty pattern, black phosphate finish
- Optimal length for greater leverage

ITEM NO.	LENGTH (mm)	DIAMETER (mm)	Hand	Box
JCEG2229	728 (28-21/32")	22	5	10

Multi-Purpose Inner Tie Rod Tool



- The master tie rod tools are specially designed to easily replace inner tie rod ends without disassembling the rack and pinion
- Operated with 1/2 inch square drive hand tools

ITEM NO.	CAPACITY (mm)	Hand	Box
JEAH0142	33 - 42	10	40

Inner Tie Rod Tool



No impact / power drive.



- Designed to remove and install the axial joint from the track rod
- Head design allows auto-grip tie rod end firmly by turning clockwise to tighten and anti-clockwise to loosen & remove axial joint
- Use with 27mm wrench or 1/2" square drive tools
- Hollow body for easy pass through and reach axial joint

ITEM NO.	CAPACITY Ø (mm)	L (mm)	Hand	Box
JEAH0245	35 - 45	400	1	10

CV Boot Clamp Pliers - Earless Type



- Designed to install & remove earless type clamps
- Quickly remove CV joint boot clamps
- Grips clamp in various position to tighten clamp around
- Works on earless type clamps including GM inboard CV joints

ITEM NO.	LENGTH (mm)	Hand	Box
JEAE0209	240 (9-1/2")	12	72

Pneumatic CV Joint Boot Installation Tool



ITEM NO.	JEBE0111
SPECIFICATIONS	
CV Joint Diameter	20 - 115 mm
Max. Air Pressure	125 PSI (9 BAR)
Working Pressure	72 - 113 PSI (5 - 8 BAR)
Air Inlet	1/4" PT
Overall Length	470 mm
Net Weight	3.5 kgs

- Specially designed for stretching flexible CV boots on to the drive shaft assemblies of automotive vehicles
- Installs flexible steering and CV Joint boots without removing axle from the vehicle or the CV joint from the axle
- Save on labor time by up to 70% and prevent damage to CV joint
- Composite body with simple control valve works from standard workshop air supply
- No additional lubricant necessary
- Suitable for most cars, small vans, light commercial vehicles
- Material: Aluminum Alloy
- Tool includes 2 pcs air nipples (European Type & Japanese Type)

C.V. Joint Banding Tool (with Cutter) / Clic-R Collar Pliers



- Use to install and tighten the band-it and strap style clamp on CV joint boots, power steering rack and pinion steering gear boots
- Bands are installed into the tool and tightened by turning the tool handle
- Use a 1/2" socket / wrench or by hand to wind the band until sufficient tension is applied
- When boot clamp has been tightened to specs, the built in cutter cuts the band by flipping tool lever (at the front of the tool) forward
- Tool is easily removed by sliding sideways after the band is tightened

ITEM NO.	LENGTH (mm)	Hand	Box
JEAE0423	230 (9")	20	60

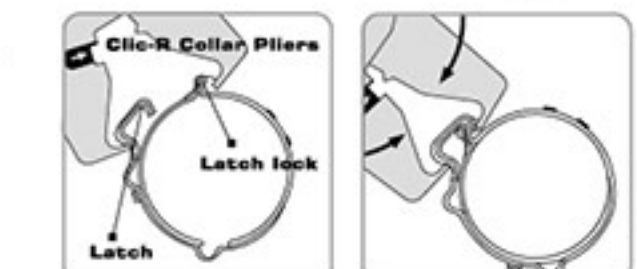

- For releasing and refitting the new style Clic and Clic-R reusable hose clamp clips
- Spring actuated joint, soft grip handles

ITEM NO.	LENGTH (mm)	Hand	Box
JEAE0107	180 (7")	12	72

CV Boot Clamp Pliers - Ear Type (Extension)



- Designed to crimp the ear type CV boot clamps used on front-wheel drive vehicles
- Pliers serve as a hose clamp installer for easy installation of Perma-Quick type hose clamps on fuel filters, water pumps, other cooling system hoses and CV joint boot clamps
- Comfort grip handle

ITEM NO.	LENGTH (mm)	Hand	Box
JEAE0509	240 (9-1/2")	12	36

CV Boot Clamp Pliers - Ear Type



- Designed to crimp the ear type CV boot clamps used on front-wheel drive vehicles
- Pliers serve as a hose clamp installer for easy installation of Perma-Quick type hose clamps on fuel filters, water pumps, other cooling system hoses and CV joint boot clamps
- Comfort grip handle

ITEM NO.	LENGTH (mm)	Hand	Box
JEAE0310	265 (10-1/2")	12	48

Front Wheel Drive Axle Puller (Steel Cable Type)



ITEM NO. JEAG0198

- Features: Use the extendable and adjustable steel cable to clip the axle / drive shaft tightly. Pull out the axle / drive shaft with slide hammer easily
- Material: Body (Iron), Slide Hammer (Cast Iron), Cable (Steel)
- Maximum Steel Cable Diameter: 100mm I.D.
- Overall Length: 980mm

Fork Type Ball Joint Separator



- Tempered drop forged steel with one piece construction for long and rough usage
- Robust fork with long length stem replaces worn out ball joints easily with a hammer striking

ITEM NO.	FORK OPENING (mm)	L (mm)	Weight (kg)	Box Qty
JEAB0330	24	300	10	20
JEAB0440	18	400	10	20

Ball Joint Separator



- Drop forged steel body and bolt for long and rough usage
- Suitable for most small cars and light vans

ITEM NO.	JAW SIZE (mm)	MAX. JAW OPENING (mm)	L (mm)	Weight (kg)	Box Qty
JEAB0116	19	50	160	1	20

Lower Ball Joint Socket (For Citroën / Peugeot Vehicles)

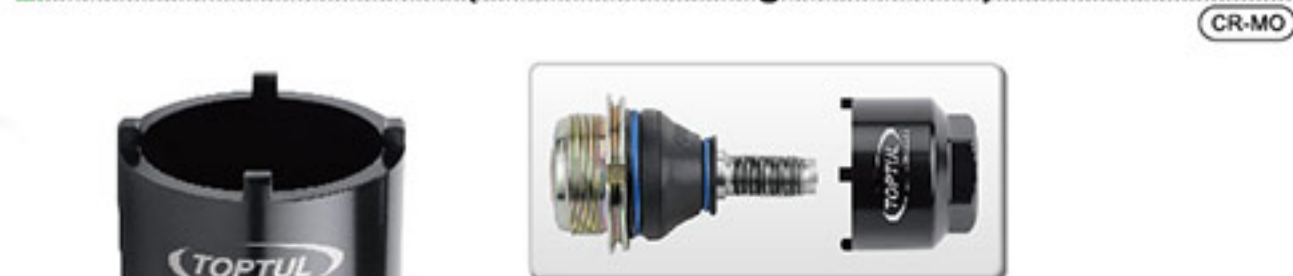

- Made of heat treated, durable Chrome Molybdenum Alloy Steel
- Designed for loosening & tightening the screw-fitted ball joint
- 35mm Hex drive with 19mm internal clearance
- Location pegs fit into slots cut in the ball joint flange
- Suitable for Citroën and Peugeot 405

ITEM NO.	L (mm)	Inner diameter Ø (mm)	Outer diameter Ø (mm)	Pin width (mm)	Weight (kg)	Box Qty
JEAB0505	45	42.5	51	4.9	6	72

Universal CV Joint Removal Puller

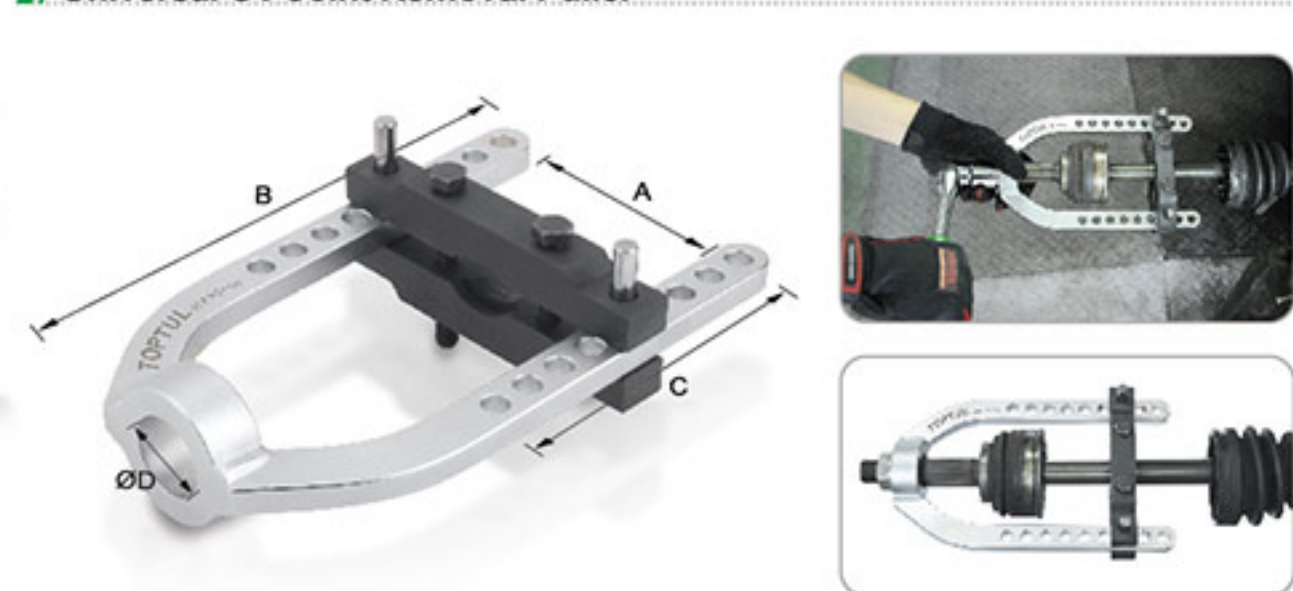

- Designed for quick and easy removal CV joints on front wheel drive cars
- Specially shaped clamping jaws ensure a secure grip on the drive shaft
- Extra wide frame and suitable for a wide range of vehicles
- Reduces risk of damaging joint and while keeps hands free for releasing retaining circlip

ITEM NO.	A (mm)	B (mm)	C (mm)	ØD (mm)	Weight (kg)	Box Qty
JEAX0101	105	250	145	32	1	8

Universal Ball Joint Separator



- Drop forged steel body and bolt for long and rough usage
- Special design two stage operation provides 30mm & 55mm maximum opening
- Suitable for most small cars and light trucks ball joints in steering and suspension

ITEM NO.	JAW SIZE (mm)	MAX. JAW OPENING (mm)	L (mm)	Weight (kg)	Box Qty
JEAB0216	22	55	160	1	20

Universal Ball Joint Separator



- For splitting track-rod ends, anti-roll bar mountings, ball joints and etc.

ITEM NO.	JAW SIZE (mm)	MAX. JAW OPENING (mm)	L (mm)	Weight (kg)	Box Qty
JEAB0505	22	50	100	1	30

Ball Joint Separator

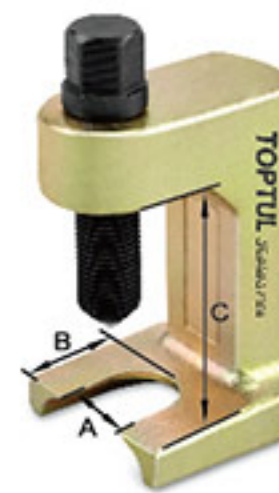

- Drop forged steel body and bolt for long and rough usage
- Suitable for splitting track rod ends, anti-roll bar mountings, steering ball joints and etc.

ITEM NO.	Jaw Size A (mm)	B (mm)	C (mm)	Weight (mm)	Weight (mm)	Applicable	Weight (kg)	Box Qty
JEAB0723	23	25	55	M16 x 1.5 x 50	17	Audi, BMW, Citroën, Ford, Opel, Mercedes-Benz, Peugeot, Renault, Rover, Saab, Volvo, VW etc.	1	24
JEAB0728	28	25	55	M16 x 1.5 x 50	17	Audi A4/A6/A8, VW, Passat ab '97 etc.	1	24

Ball Joint Separator



- Drop forged steel body and bolt for long and rough usage
- Suitable for splitting track rod ends, anti-roll bar mountings, steering ball joints and etc.

ITEM NO.	Jaw Size A (mm)	B (mm)	C (mm)	Weight (mm)	Weight (mm)	Weight (kg)	Box Qty
JEAB0618	18	36	38	M14 x 1.5 x 50	17	1	48
JEAB0623	23	45	47	M16 x 1.5 x 70	17	1	12
JEAB0629	29	62	65	M18 x 1.5 x 90	19	1	12
JEAB0640	40	63	76	7/8"-14 UNF x 135	24	1	12
JEAB0646	46	76	100	7/8"-14 UNF x 135	24	1	12

Pitman Arm Puller

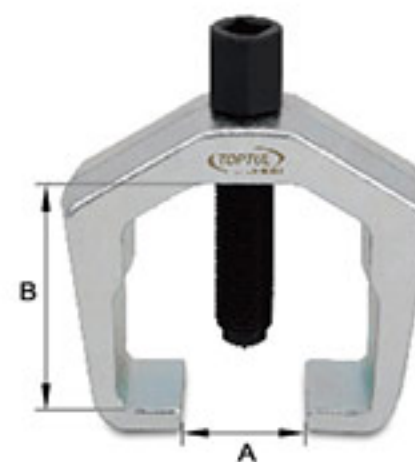

- Drop forged steel body and bolt for long and rough usage
- Design to remove tie rod ends and pitman arm assemblies from most car and light trucks

ITEM NO.	Jaw Size A (mm)	B (mm)	Weight (mm)	Weight (mm)	Weight (kg)	Box Qty
JEAB0833	33	64	5/8"-18 UNF x 86	19	6	24

15PCS Multi-Steering Knuckle Spreader Tool Set



ITEM NO. JGAI1501 12 (SET)

- Suitable for removal and refitting of shock absorbers without the risk of damage to the Aluminum or cast iron knuckle
- For steering knuckles with either a centralized slot or a non centralized slot
- Designed for twin ball joints as fitted to Audi and VW control arms
- Application for most vehicles such as Audi, BMW, Citroën, Ford, Peugeot, Renault, Seat, Skoda, VW and etc.

BLOW CASE: W195 x D140 x H40 (mm)

Hub Slide Hammer Puller

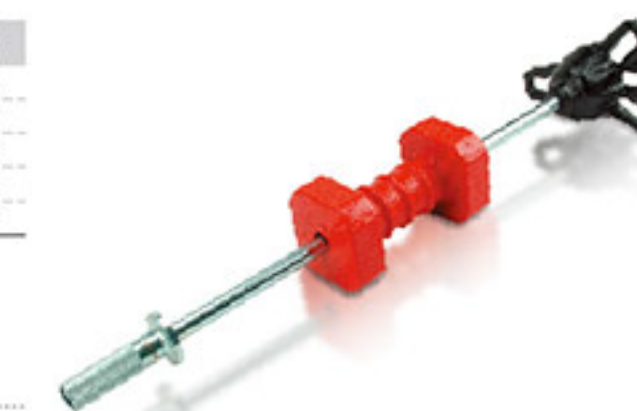

ITEM NO. JEA10167

- Features: Pulls and removes flange-type rear axles on most late model passenger cars and light trucks. Designed to work on axles with bolts and studs up to 9/16" diameter. Fits 4 & 5-bolt pattern hub, stud circle diameter range from 4" - 6". Heavy duty slide hammer action with 10 lbs (4.5 kgs) hammer for tough pulling jobs

Slide Hammer Puller Set



KIT CONTENT



ITEM NO. JGAI1303 2 (SET)

• Features: Most commonly used tool set to pull and removes flange-type rear axles, oil seals, bearings and press-fits parts. Designed to work on multi-purpose works and 8 functional assembly; external 3-jaw puller, internal 3-jaw puller, external 2-jaw puller, internal 2-jaw puller, grip wrench adapter, puller hook, rear axle puller, dent puller to suits different pulling & removing jobs.

BLOW CASE: W600 x D210 x H100 (mm)



Internal 2-Jaw Puller

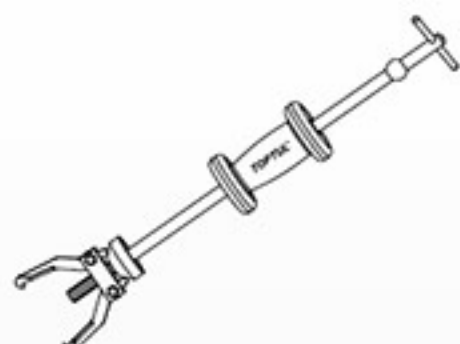

External 2-Jaw Puller



Internal 3-Jaw Puller

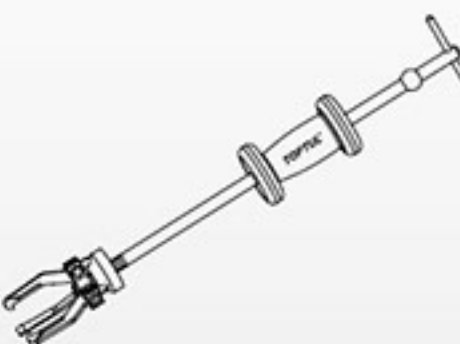

External 3-Jaw Puller

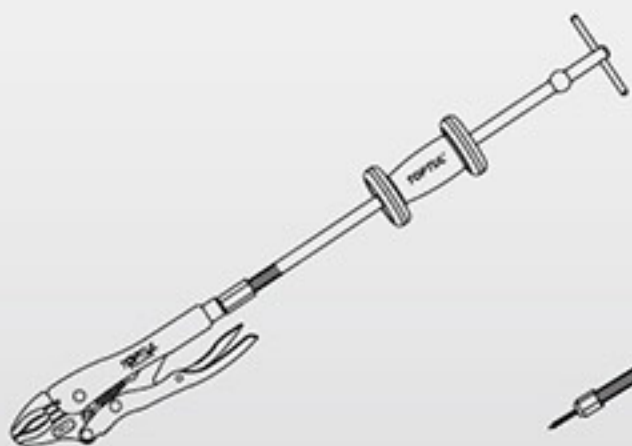

Grip Wrench Adapter

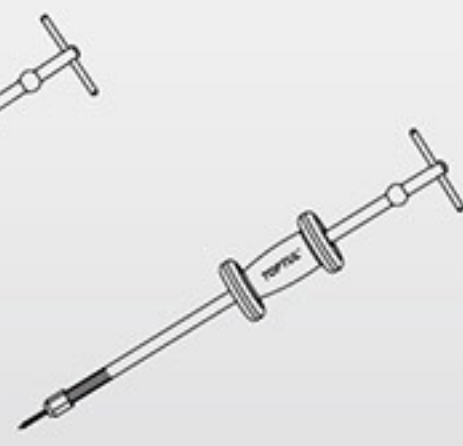

Dent Puller

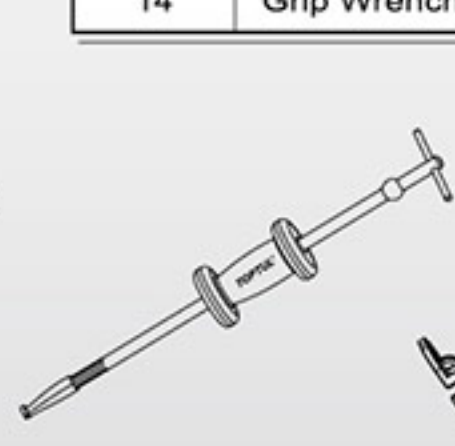

Puller Hook

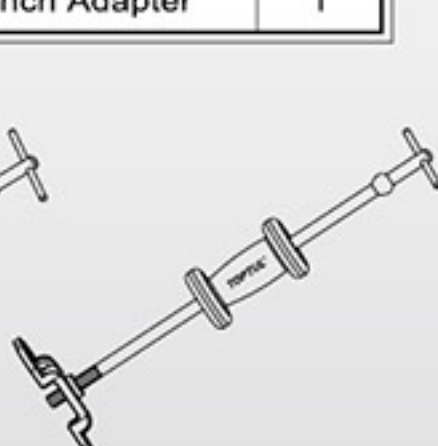

Rear Axle Puller

Part No.	Description	Q'ty
1	T Bar	1
2	Hammer	1
3	Axle Puller	1
4	Deep Axle Puller	1
5	Cone	1
6	2 Jaw Head	1
7	3 Jaw Head	1
8	Nut & Bolt	3
9	Jaw	3
10	Attachment	1
11	Screw	1
12	Hook	1
13	Centre Screw	1
14	Grip Wrench Adapter	1

36PCS Self-Adjusting Clutch Alignment Tool Kit



Ten Alignment Adapter



Pretension Clutch



Resetting Tool



Face Spanner (Audi, Seat, Skoda and VW)

ITEM NO. JGAI3601 2 (SET)

• Suitable for most self adjusting clutches SAC (3 and 4 points) equipped on vehicles of VW, Audi, BMW, Fiat Group, Mercedes-Benz, Opel, Renault, Volvo etc.
• Tool kits allow operations on clutch with this device can prevent any damage to system and to keep adapter ring in right position
• Necessary tools for easy pre-tensioning self adjusting clutches before removal or installation
• Prevents clutch plate distortion and avoid unexpected of clutch from disengaging or dragging
• Equipped a refitting tool, can allow the clutch adjuster to be wound back, and ten alignment adapters. Alignment of clutch disk to drive bearing & disk pushing plate
• Kit includes a clamping tool for SAC clutches with 3(4) hole pitch, a compression strut, 2 handle for clamping tool, a face spanner, a clutch resetting tool, 10 alignment adapter, 4 threaded bolts - M6 · M7 and M8, 4 knurled nuts, 4 screw - M8

BLOW CASE: W435 x D400 x H82 (mm)

Universal Clutch Aligner



• Design for easy aligning the clutch and pressure plate before installation
• Suitable for most vehicles up to approximately 5 tons with single plate clutches
• Made of special plastic for light and durable body
• Supplied with 3 different sized expanding collets
Collets: Ø15-18mm; Ø18-21mm; Ø22-28mm

ITEM NO.	CAPACITY Ø (mm)	Q'ty
JEAN0131	15 - 28	12 48



PNEUMATIC CALIPER DISC BRAKE WIND BACK TOOL SET



4PCS Pneumatic Caliper Disc Brake Wind Back Tool

- Designed to wind back brake caliper pistons when servicing brake calipers or replacing brake pads
- Air supply ram applies pressure to adjust the caliper piston easily while rotating handle back by hand
- For left and right handed threaded brake caliper piston rewind
- Easy operated, applies in workshop by standard air supply system
- Suitable for most pin type adapters



ITEM NO.	Air Pressure	Air Inlet	Type	5	10
JEBF0226E	5 - 8 BAR	1/4" PT	EU	5	10
JEBF0226J	5 - 8 BAR	1/4" PT	JP	5	10

18PCS

Pneumatic Caliper Disc Brake Wind Back Tool Set



- Designed for adjusting wind & pistons back into caliper when servicing brake calipers or replacing brake pads
- Air supply ram applies pressure to adjust the caliper piston easily, while rotating handle back by hand
- Easy operated, applies in workshop by standard air supply system
- Multipurpose tool set with mostly completely range of 17 adapters for brake assemblage, and cover various type of popular vehicles
- Suitable for Mercedes-Benz, BMW, Audi, VW, Opel, Volvo, Jaguar, Citroën, Fiat, Peugeot, Alfa Romeo, Saab, Lancia, Toyota, Honda, Nissan, Mitsubishi, Isuzu, Mazda, Subaru, GM, Ford, Rover etc.

ITEM NO.	CONTENTS	5 (SET)
JGAI1804	1 Pneumatic caliper disc brake wind back tool (Air Pressure: 5-8 BAR ; Air Inlet: 1/4" PT) European Type (Item No. JGAI1804E) Japanese Type (Item No. JGAI1804J)	
	17 Brake piston adapters	

BLOW CASE: W350 x D306 x H87 (mm)

3PCS Brake Caliper Rewind Tool (Right-Hand Thread)



- Designed for rewinding brake piston with right-handed thread
- Fitted for most European and Japanese Cars with right-handed thread
- Expert quality, complete with reaction plate and double sided adapter
- Adapter double sided:
 - 1 side: (22mm centers / 6mm diameter pins (approx.) Alfa Romeo, Audi, Citroën, Fiat, Ford, Honda, Jaguar, Nissan, Peugeot, Renault, Rover, Saab, Seat, Subaru, VW, Volvo and etc.
 - 2 side: (33mm centers / 6mm diameter pins (approx.) Ford, Mazda, Mitsubishi, Toyota and etc.

ITEM NO.	CONTENTS	5	30
JGAR0304	1 Right-hand threaded rewind tool with T-handle		
	1 Reaction plate	5	30
	1 Double sided brake piston adapter		

4PCS Right & Left Hand Thread Brake Caliper Rewind Tool



- Double-ended design for retracting right and left-handed rear caliper pistons
- For quick and efficient winding of brake pistons with RH & LH threads
- Ideal for replacing brake pads and easy to carry out the maintenance work during applications
- Suitable for most vehicles

ITEM NO.	CONTENTS	5	20
JGAR0402	1 2 in 1, 3/8" Dr. Right & Left Hand Thread Brake Caliper Rewind Tool		
	1 Sliding Bar	5	20
	1 Reaction Plate		
	1 3/8" Adapter with Magnet		

18PCS Universal Caliper Disc Brake Wind Back Tool Kit



- This tool is designed to wind back brake caliper pistons when servicing brake calipers or replacing brake pads
- Expert Quality, left hand and right hand threaded rewind tools allow the easy return of the brake piston into the caliper to provide clearance for new brake pads
- Application for most cars, such as Audi, Ford, Nissan, Alfa Romeo, Saab, Subaru, BMW, Toyota, Jaguar, VW, GM and etc.

ITEM NO.	CONTENTS	8 (SET)
JGAI1801	2 Left and right hand threaded rewind tools	
	1 Reaction plate	
	15 Brake piston adapters	

BLOW CASE: W325 x D255 x H50 (mm)

6PCS Right & Left Hand Thread Brake Caliper Rewind Tool Kit



- Double-ended design for retracting right and left-handed rear caliper pistons
- Ideal for replacing brake pads and easy to carry out the maintenance work during applications
- Adjustable 2 pin & 3 pin brake piston wind back adapters cover a wide range of vehicle application
- Quickly and easily operated from 20mm to 35mm distance between pin centers (Pins diameter Ø4mm)
- Three-pin design suit a Electronic Park Brake (EPB) and VAG vehicles
- Includes magnetic 2 pin drive to 3/8" adapter

ITEM NO.	CONTENTS	10 (SET)
JGAI0601	1 2 in 1, 3/8" Dr. Right & Left Hand Thread Brake Caliper Rewind Tool	
	1 Sliding Bar	
	1 Reaction Plate	
	1 3/8" Adapter with Magnet	
	1 2 Pin Adjustable Brake Piston Wind Back Adapter	
	1 3 Pin Adjustable Brake Piston Wind Back Adapter	

BLOW CASE: W260 x D170 x H60 (mm)

12PCS Universal Caliper Disc Brake Wind Back Tool Kit



- Magnetic socket adapter
- Including 10 adapters for brake assemblage
- For rotating pistons back into caliper to provide clearance for new pads
- Prevents damage to the piston and boot
- Suitable for VW, Audi, Ford, Nissan, Alfa Romeo, Rover, Saab, Subaru, Toyota, Jaguar and most of the general motors

ITEM NO.	CONTENTS	10 (SET)
JGAI1201	1 Right hand threaded rewind tool	
	1 Reaction plate	
	10 Brake piston adapters	

BLOW CASE: W325 x D255 x H50 (mm)

2 Pin Adjustable Brake Piston Wind Back Adapter



- Adjustable two-pin brake piston wind back adapters cover a wide range of vehicle application
- Operated by rotating the top section and easily operated from 20mm to 35mm distance between pin centers (Pins diameter Ø4mm)
- Pins designed to shear at 110Nm
- Use with 3/8" square drive caliper disc brake wind back tool

ITEM NO.	DRIVE	PIN	CAPACITY (mm)	10	100
JEBY0235	3/8"	2	20 - 35	10	100

3 Pin Adjustable Brake Piston Wind Back Adapter



- Adjustable three-pin design suit a Electronic Park Brake (EPB) and VAG vehicles
- Operated by rotating the top section and easily operated from 20mm to 35mm distance between pin centers (Pins diameter Ø4mm)
- Pins designed to shear at 110Nm
- Use with 3/8" square drive caliper disc brake wind back tool

ITEM NO.	DRIVE	PIN	CAPACITY (mm)	10	100
JEBY0335	3/8"	3	20 - 35	10	100

2PCS 2&3 Pin Adjustable Brake Piston Wind Back Adapter Set



- Expert quality, adjustable 2 pin & 3 pin brake piston wind back adapters cover a wide range of vehicle application
- Quickly and easily operated from 20mm to 35mm distance between pin centers (Pins diameter Ø4mm)
- Three-pin design suit a Electronic Park Brake (EPB) and VAG vehicles
- Use with two-pin drive tool

ITEM NO.	CONTENTS	24	48
JGAR0202	1 JEAY0235 2 Pin Adjustable Brake Piston Wind Back Adapter		
	1 JEAY0335 3 Pin Adjustable Brake Piston Wind Back Adapter	24	48

3/4" DR. Spline Bit Impact Socket



- Made of impact quality Chrome Molybdenum Alloy Steel
- This tool is designed to loosen and tighten wheel bearing / hub unit retaining bolts at the rear axle
- Applicable: Audi A3, VW Golf / Golf Plus / Jetta / Touran / Eos / Passat, Seat Altea / Leon / Toledo and etc.

Black Phosphate Finished

DRIVE	ITEM NO.	SIZE	L (mm)	1	18
3/4"	KADB2418	M18	105	1	18

20mm sq.

Thin Wall Deep Impact Socket with Plastic Sleeves (For Mercedes-Benz)



- Made of Chrome Molybdenum Steel
- Deep thin wall allows easy access to recessed wheel nuts
- Resin cap insert protect lug nuts and bolts to against impact damage
- With protection sleeves for reducing the risk to damage alloy rims
- Application: Mercedes-Benz C and GLK-Class (W204), E-Class (W211, W212, W207), SLK-Class (W172), ML-Class (W164, W166), CL-Class (W216), S-Class (W221, W222)

DRIVE	ITEM NO.	SIZE (mm)	L (mm)	COLOR	20	80
1/2"	KABQ1617	17	78	White	20	80

12.5mm sq.

1/2" DR. 12PT Flank Deep Impact Sockets



Black Phosphate Finished

DRIVE	ITEM NO.	SIZE (mm)	L (mm)	5	20
1/2"	KABJ1630	30	78	5	20
	KABJ1632	32	78	5	20
	KABJ1636	36	78	5	20

12.5mm sq.

1/2" DR. Spline Bit Impact Sockets



Black Phosphate Finished

DRIVE	ITEM NO.	SIZE	L (mm)	25	250
1/2"	KADB1614S	M14	44	25	250
	KADB1616S	M16	44	25	250
	KADB1618S	M18	44	25	250
	KADB1614L	M14	77	15	120
	KADB1616L	M16	77	15	120
	KADB1618L	M18	77	15	120

12.5mm sq.

8PCS Lug Nut Remover / Wheel Lock Removal Tool Kit



- Deep reverse-tapered internal threads inside the socket wall to grip the locking wheel nut or stripped lock

- Made of Chrome Molybdenum Steel
- Standard 1/2" square drive socket
- Impact-grade hardened and tempered socket
- 8-piece set fits small, medium, large lug nuts and locks
- Deep reverse-tapered internal threads to grip the locking wheel nut or stripped lock on most vehicles
- Removes factory and most aftermarket wheel lug nut lock without factory original key
- Thin wall design socket fit wheel lock diameter to prevent scratching wheels
- Suitable for use with 1/2" drive impact tools
- Black phosphate finish for extra corrosion resistance

ITEM NO.	CONTENTS	12 (SET)
JGAI0802	JEAK1617~1628 1/2" Dr. Locking Wheel Nut Removal Sockets 17, 18.5, 20, 21.5, 23, 24.5, 26, 27.5 mm	

BLOW CASE: W250 x D155 x H55 (mm)

3PCS 1/2" DR. Hub Nut Deep Impact Socket Set



- Heavy duty, professional quality 12-point deep impact sockets, manufactured from hardened and tempered Chrome Molybdenum Steel
- Suitable for hub nut applications where high torque is required
- Set contains three sockets for a sure grip on the most common sized hub nuts
- Black phosphate finish for added corrosion resistance
- Applications: Audi, VW, Alfa Romeo, BMW, Citroën, Fiat, Ford, Opel, Mercedes-Benz, Peugeot, Renault and etc.

ITEM NO.	CONTENTS	10 (SET)
GDAI0303	KABJ1630~1636 1/2" Dr. 12PT Flank Deep Impact Sockets (78 mmL) 30, 32, 36 mm	

BLOW CASE: W170 x D105 x H70 (mm)

6PCS 1/2" DR. Spline Bit Impact Socket Set

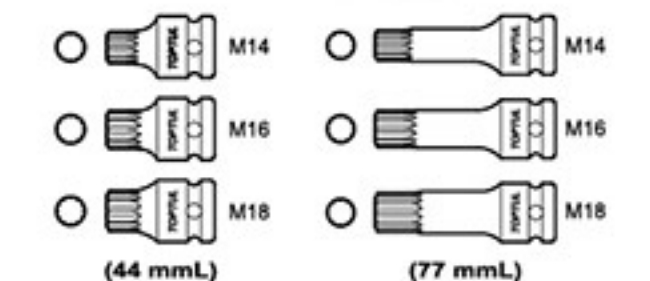

- Expert quality, tempered and hardened Nickel Chrome Molybdenum Steel (SNCM+V) socket bits
- Spline bit M14/M16/M18, each size in two lengths 44 & 77 mmL
- Suitable for removal and adjustment of hubs, steering and suspension especially on VAG vehicles and etc.
- Use with 1/2" square drive impact tools
- Black phosphate finish for extended corrosion resistance

ITEM NO.	CONTENTS	20 (SET)
GDAI0601	KADB1614S~KADB1618S 1/2" Dr. Spline Bit Impact Sockets (44 mmL) M14, M16, M18	
	KADB1614L~KADB1618L 1/2" Dr. Spline Bit Impact Sockets (77 mmL) M14, M16, M18	

BLOW CASE: W130 x D107 x H53 (mm)

MacPherson Spring Dumper Extractor (Replaceable)

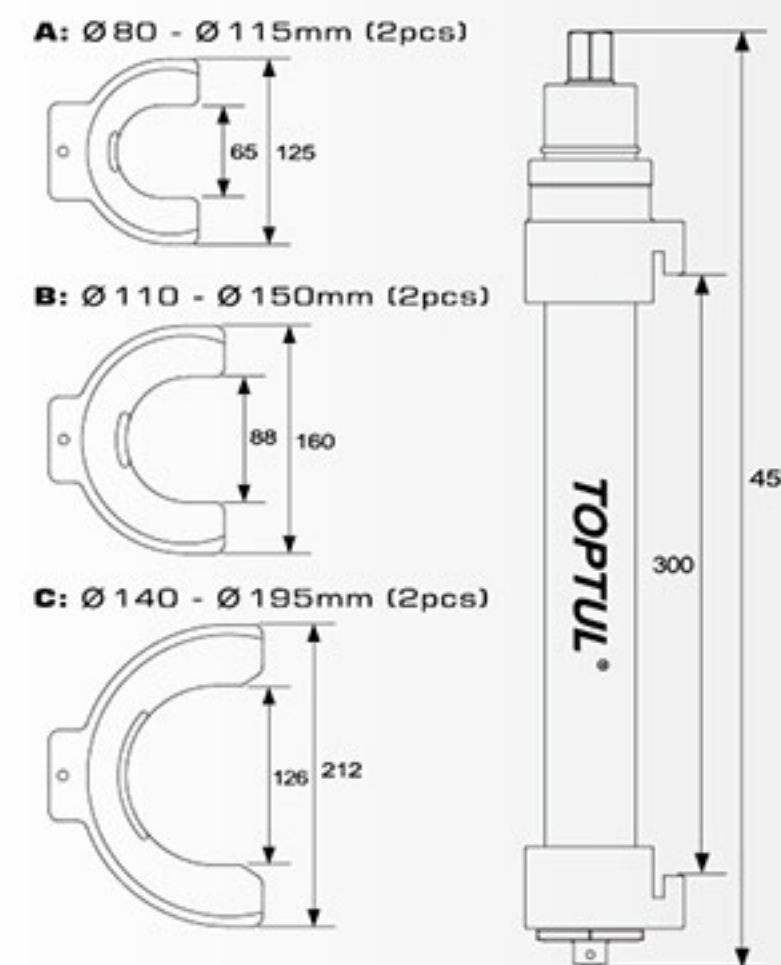

- | ITEM NO. | JGAI0801 | 1 (SET) |
|----------|---|---------|
| | Spring compressors are multi-application tools specifically, developed for MacPherson suspensions, using a range of 3 sets of interchangeable mono block forks / jaws | |
| | The assembly / disassembly of the springs at all types of MacPherson strut | |
| | For MacPherson shock absorber springs and equivalent shock absorber | |
| | Application: BMW, Toyota, Ford, Mitsubishi, VW, Audi, Saab, Nissan, Honda, Accord, Subaru, Volvo, Opel and Porsche | |
| | Material: Chrome Molybdenum Steel | |
| | Spring Specification / Use Range:
A: Ø 80 - Ø 115 mm B: Ø 110 - Ø 150 mm
C: Ø 140 - Ø 195 mm | |
| | Max. Load: 3,500 kgf | |
| | Hand-operated tools | |
- BLOW CASE: W530 x D460 x H110 (mm)



No impact / power drive.

2PCS Coil Spring Compressor Set



- Drop forged Chrome Molybdenum Steel jaws and lead screws (270mm)
- For use with 21mm wrench or 1/2" square drive tools
- Jaw design is suitable for use in confined areas under wheel arch
- The tool is designed to wrap coil claws for safety

ITEM NO.	MAX. JAW OPENING	1	6
JEAC0127	270 mm	1	6

2PCS Coil Spring Compressor Set



- Drop forged Chrome Molybdenum Steel jaws and lead screws (370mm)
- For use with 21mm wrench or 1/2" square drive tools
- Jaw design is suitable for use in confined areas under wheel arch
- The tool is designed to wrap coil claws for safety

ITEM NO.	MAX. JAW OPENING	1	6
JEAC0137	370 mm	1	6



8PCS
Pressure Screw Bearing Separator Puller Set



• Pull out the bearing with the H-type beam and bolts

ITEM NO.	CONTENTS	2 (SET)
JGAD0801	1 Bearing Separator Set (Capacity 75 - 105mm)	
	2 Main Rod	
	2 Extension Rod	
	1 Beam	
	1 Central Bolt	
	1 Central Nut	
METAL CASE: W447 x D188 x H53 (mm)		

12PCS
Bearing Separator Kit



• Pull out the bearing with the H-type beam and bolts

ITEM NO.	CONTENTS	3 (SET)
JGAD1201	1 Bearing Separator Set (Capacity 30 - 50mm)	
	1 Bearing Separator Set (Capacity 50 - 75mm)	
	4 Main Rod	
	4 Extension Rod	
	1 Beam	
	1 Central Bolt	
METAL CASE: W447 x D188 x H53 (mm)		

Bearing Separator Set

CR-MO



ITEM NO.	SIZE (mm)	EXTENSION ROD	1	2
JEAD0305	30 - 50	3/8" - 16T	1	20
JEAD0508	50 - 75	3/8" - 16T	1	12
JEAD0811	75 - 105	1/2" x 16T	1	10
JEAD1115	105 - 150	5/8" - 11T	1	5



• JGAD1201 • JGAD0801

24PCS
FWD Front Wheel Bearing Removal & Installation Tool Kit



1 Assembly

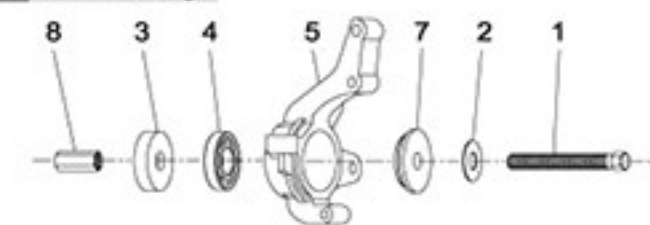

2 Disassembly

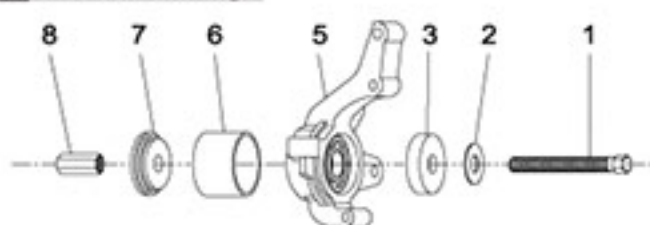

1	Screw
2	Washer
3	Bearing Cap
4	Bearing
5	Hub
6	Barrel
7	Barrel Cap
8	Adjusting Nut

ITEM NO.	JGAI2401	2 (SET)
• Comprehensive kit for the removal and installation of front hub bearings		
• Remove and replace front hub bearings without the need to dismantle the steering knuckle and strut assembly		
• Works on most domestic and imported FWD cars and light trucks		
• Black phosphate finish for corrosion resistance		
• 14 sizes bearing cap diameter: 50, 55, 59, 63.3, 66.5, 70.3, 71.5, 73.1, 73.4, 74.8, 77.5, 81.5, 83.4, 88.4 mm		
• 4 sizes barrel diameter: 76, 86, 91, 102 mm		
• 2 sizes barrel cap diameter: 86, 102 mm		
• Use with 27mm or 32mm wrench or socket		

BLOW CASE: W430 x D390 x H105 (mm)

27PCS
Universal Bearing and Bush Remove / Install Sleeve Kit



1 Removal Bush

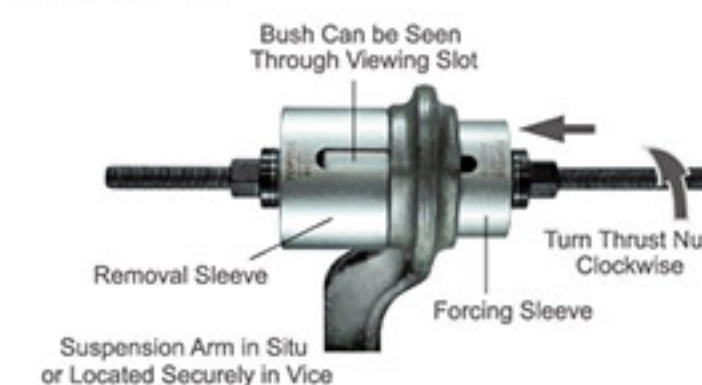

2 Installation Bush

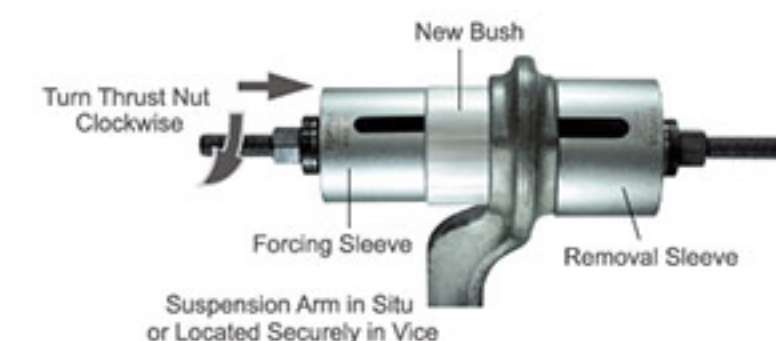

ITEM NO.	JGAI2701	1 (SET)
• Designed for assembly & disassembly the bearing		
• Ideal for extracting and inserting silent bearings, hydraulic bearings, bearing bushes, ball bearings, shaft seals, rubber bearings, seals, etc.		
• Universal application for both on vehicle and hydraulic press		
• Suitable for working on various vehicles, e.g. commercial cars, truck, van		
• Each sleeves can be individually reworked		
• Sleeves are slotted for easy viewing aperture during application		
• Sets included, 5 threaded bars and thrust nuts in M10, M12, M14, M16 and M18 (Length: 350mm)		
• 22 pcs pressure sleeves (outer Ø x inner Ø): 44x34, 46x36, 48x38, 50x40, 52x42, 54x44, 56x46, 58x48, 60x50, 62x52, 64x54, 66x56, 68x58, 70x60, 72x62, 74x64, 76x66, 78x68, 80x70, 82x72, 85x75, 90x80 mm		

BLOW CASE: W470 x D415 x H115 (mm)

Master Bearing Race and Seal Driver (Adjustable)



Fully Closed



Fully Opened



- All in one design eliminates the need for a driver and several different heads
- Durable sturdy Aluminum construction with a steel capped striker shaft handle
- Designed for installing bearing race and seal without any damage during application
- 3-stepped jaws quickly adjust to accommodate bearing race and seals
- Locking screw holds the adjustable jaws in place for one hand use
- Suitable for most vehicles, including motorcycles

ITEM NO.	Total	JAWS RANGE (mm)			L (mm)	1	48
		Step 1	Step 2	Step 3			
JEBC1050	9.5 - 50	9.5 - 23.5	23.5 - 36.5	36.5 - 50	176	1	48
JEBC1890	18 - 90	18 - 53	41 - 76	54 - 90	210	1	20

Heavy Duty Seal Puller



- Removes oil & grease seals
- Two tips fit most application

ITEM NO.	LENGTH (mm)	12	48
JDAK0132	318 (12-1/2")		

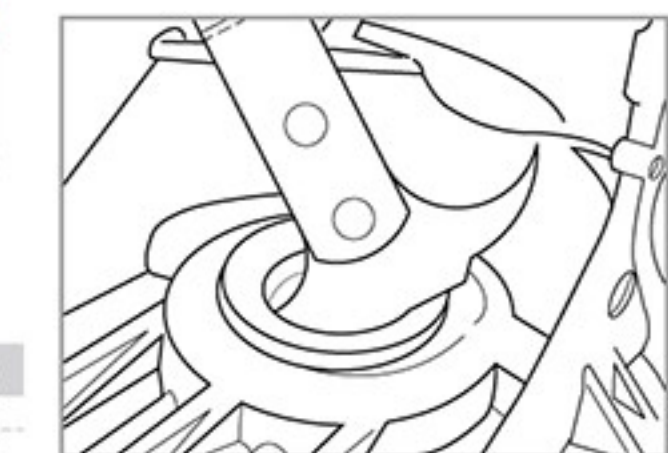

3-Function Tire Pressure Gauge



PROFESSIONAL TIRE INFLATOR WITH GAUGE



Variable Trigger & Control Position
Gauge Pressure / Measuring (Release)
Release Air / Deflation (Press Halfway Down)
Fill Air / Inflation (Press Down)

ITEM NO. JEAL160A 12 (SET)

- Multi-Function Tire Pressure Gauge:
 1. Check Pressure
 2. Inflate
 3. Deflate
- Pressure Range: 0 - 160 psi, 0 - 11 bar
- Flexible 20" high pressure rubber hose with clip-on air tire chuck
- Variable trigger, two control position inflate / deflate level
- Simple and easy operation model
- Ideal for automotive tires
- Air Inlet: 1/4" PT

3-Function Tire Pressure Gauge



• Convenient Clip-On Tire Chuck

ITEM NO. JEAL220A 12 (SET)

- Multi-Function Tire Pressure Gauge:
 1. Check Pressure
 2. Inflate
 3. Deflate
- Large and easy-reading 3-1/2" diameter gauge with protective rubber sleeve
- Pressure Range: 0 - 15 kg/cm², 0 - 220 psi, 0 - 15 bar, 0 - 1500 kpa
- Aluminum die-casting body with H-D brass valves
- Flexible 20" high pressure rubber hose
- Clip-on air tire chuck design enables hands-free chuck use
- Variable trigger, two control position inflate/deflate level
- Simple and easy operation model
- Ideal for automotive tires especially truck tires
- Built in hang-up hook allows for easy storage
- Air Inlet: 1/4" PT

3-Function Tire Pressure Gauge W/ Dual Tire Chuck



• 10" Chrome Plated Steel Dual Chuck (Offset Dual Head Air Tire Chuck)

ITEM NO. JEAL220B 12 (SET)

- Multi-Function Tire Pressure Gauge:
 1. Check Pressure
 2. Inflate
 3. Deflate
- Large and easy-reading 3-1/2" diameter gauge with protective rubber sleeve
- Pressure Range: 0 - 15 kg/cm², 0 - 220 psi, 0 - 15 bar, 0 - 1500 kpa
- Aluminum die-casting body with H-D brass valves
- Flexible 40" high pressure rubber hose with 10" Chrome Plated Steel dual chuck
- Offset dual head air tire chuck allows easy access to all valves
- Variable trigger, two control position inflate/deflate level
- Simple and easy operation model
- Ideal for automotive tires especially truck tires
- Built in hang-up hook allows for easy storage
- Air Inlet: 1/4" PT

Economy Handy Series Tire Pressure Gauge



- Large and easy-reading 2" diameter gauge with protective rubber sleeve
- Pressure Range: 0 - 4 kg/cm², 0 - 60 psi, 0 - 4 bar
- ABS plastic body, internal diaphragm construction for increasing the durability
- Equipped with 45° angle chuck and pressure reset button
- Built-in Air Bleeder Valve
- Simple and easy operation model
- Ideal for motorcycle or automotive tire
- Calibrated to ANSI B40.1 Grade B Accuracy Standards

ITEM NO. Pressure Range Diameter Gauge 12 48

JEAP060A 0 - 60 psi (0 - 4 kg/cm², 0 - 4 bar) 2" 12 48

Dual Tire Chuck

- Chrome plated steel dual air tire chuck
- Offset dual head chuck allows easy access to all tire valve stems
- Ideal for automobile tires especially truck tires
- Comfort, Anti-slip plastic grip handle
- Air inlet: 1/4" PT
- Head I.D.: 8mm

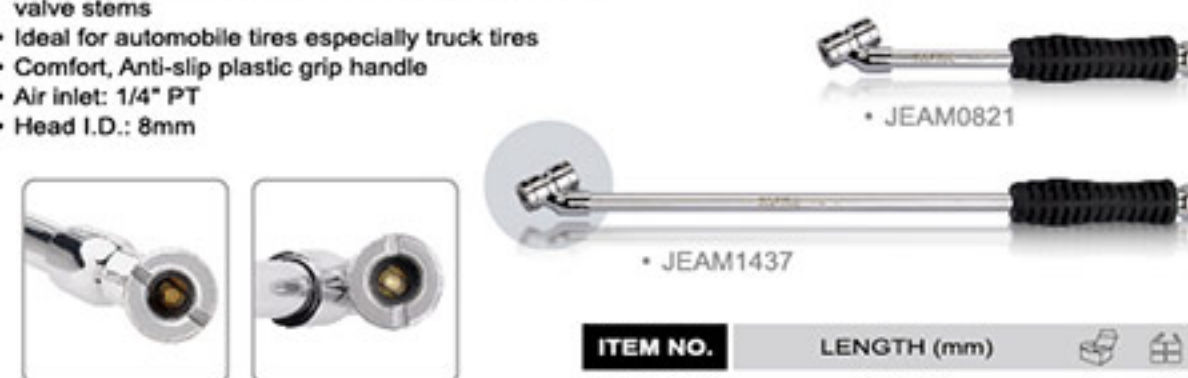

ITEM NO.	LENGTH (mm)	Weight	Volume
JEAM0821	205 (8")	5	100
JEAM1437	370 (14")	5	100

Tire Valve Core Torque Screwdriver



- Design for removing and installing of valve cores
- Preset torque setting to prevent over torquing and reduce risk of damage on TPMS valves sensor cores
- Ergonomic comfort-grip handle with TPR material

ITEM NO.	TORQUE	LENGTH (mm)	Weight	Volume
JEBO105	0.45 Nm (4.0 in-Lb)	150	24	96

Tire Valve Installer



- Steel constructed deep threaded head for positive sealing of all snap-in car tire valve stems
- 180 degree pivoting head design to provide leverage at any angle against wheels
- Simplifies installation of tire valve in tubeless wheels
- Pulls tire valve assembly through rim
- Protective rubber covering on the shaft to avoid damage and marking of alloy wheels
- Shaft is notched to accommodate various rim styles

ITEM NO.	LENGTH (mm)	Weight	Volume
JEBO133	325	6	48

Tire Valve Installer - Plastic Type



- Steel constructed deep threaded head for positive sealing of all snap-in car tire valve stems
- 180 degree pivoting head design to provide leverage at any angle against wheels
- Simplifies installation of tire valve in tubeless wheels
- Pulls tire valve assembly through rim
- Elastic nylon handle to avoid damage and marking of alloy wheels
- The tire valve core removal tool is mounted at the end of the handle
- Shaft is notched to accommodate various rim styles

ITEM NO.	LENGTH (mm)	Weight	Volume
JEBO234	335	12	144

Brake Fluid Tester



- Designed for checking quality of brake fluid (DOT 4)
- Five LED to indicate the percentage of water in the brake fluid
- Quick & simple tool for testing brake fluid in most type of vehicles, trucks, motorcycles and etc.

ITEM NO.	LENGTH (mm)	Weight	Volume
JJBD0101	150	10	100



4PCS
Unique Compression Tester Kit (Petrol Engine)



- ITEM NO.** JGAI0402 **6 (SET)**
- Use to check cylinder compression to assist in the diagnosis of faulty valves, piston rings, cylinder heads, gaskets and etc.
 - Large, shock protected, easy-reading 2-1/2" diameter gauge with dual calibration 0 - 300 psi, 0 - 21 kg/cm²
 - Gauge head with pressure relief valve for repeated test of cylinder without removing gauge
 - 13" durable rubber extension hose with built in M14 adapter and one separate M18 adapter
 - 8" Heavy-Duty Aluminum extension tube with universal rubber cone adapter fits all plug holes

BLOW CASE: W260 x D170 x H60 (mm)

13PCS
Compression Tester Set (Diesel Engine)



- ITEM NO.** JGAI1302 **6 (SET)**
- Comprehensive test kit for checking compression on both direct and indirect injection diesel engine vehicles
 - Large, shock protected, easy-reading 2-1/2" diameter gauge with dual calibration 0 - 1000 psi, 0 - 70 bar
 - Gauge head with built-in pressure relief valve for repeated test of cylinder without removing gauge
 - 15" flexible hose allows easy access to restricted plug and injector ports
 - Quick-connect coupler for easy and secure connection
 - Includes replacement seal & washer set
 - Applications: BMW, VW, Volvo, Renault, Fiat, Seat, Mercedes-Benz, Citroën, Opel, Peugeot, Daihatsu, Toyota, Nissan, Isuzu, Mazda, Mitsubishi, Ford, Vauxhall, Land Rover and etc.

BLOW CASE: W380 x D310 x H80 (mm)

81PCS
Gasoline Engine Fuel Injection Pressure Tester Kit

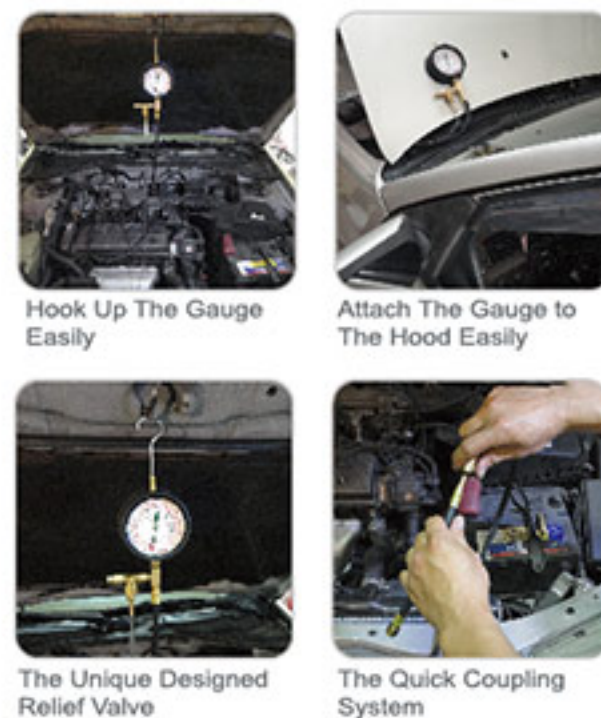

- ITEM NO.** JGAI8101 **2 (SET)**
- Excellent fuel injection pressure test kit assists in identifying and diagnosing low fuel pressure, a faulty fuel pressure regulator, leaking injectors, fuel leaks and clogged fuel filters
 - Large, shock protected, easy-reading 3-1/2" diameter fuel pressure gauge with dual scale reading of 0 - 120 psi and 0 - 8 bar
 - Comprehensive kit of adapters and fittings for most fuel injection systems of American, Japanese, European vehicles including Multi-Port Fuel Injection (MPI) system, GM TBI system and Bosch CIS system
 - Kit contains gauge, hose, adapters, tubing, manifolds, plugs plus repair kits of spare washers, seals, o-rings, clamps, fuel hose, bushes and other accessories
 - Applications: BMW, VW, Audi, Volvo, Saab, Ford, Chrysler, Fiat, Honda, Hyundai, Isuzu, Mazda, Porsche, GM, Mercedes-Benz, Peugeot, Suzuki, Toyota, Mitsubishi, Jeep and etc.

BLOW CASE: W360 x D430 x H160 (mm)

7PCS
Multi-Port Fuel Injection Pressure Tester Kit



The Uniquely Designed Pressure Relief Valve



The Quick Coupling System

- ITEM NO.** JGAI0703 **6 (SET)**
- Excellent fuel injection pressure test kit assists in identifying and diagnosing low fuel pressure, a faulty fuel pressure regulator, leaking injectors, fuel leaks and clogged fuel filters
 - Large, shock protected, easy-reading 3-1/2" diameter fuel pressure gauge with dual scale reading of 0 - 150 psi and 0 - 1000 kPa
 - All adapters, gauge and hose assemblies feature a quick coupling system for speedy and efficient testing connection
 - For Multi-Port Fuel Injection (MPI) system
 - Applications: American vehicles Ford, Chrysler, GM and etc.

BLOW CASE: W592 x D261 x H62 (mm)

12PCS
Oil Pressure Tester Kit



2-1/2" Diameter Gauge (150 PSI / 10 BAR) with Relief Valve, 51" Hose with Quick Coupler

- ITEM NO.** JGAI1204 **6 (SET)**
- Design to diagnose worn oil pumps and engines, faulty oil pressure switches and warning indicators
 - Large, shock protected, easy-reading 2-1/2" diameter gauge with dual calibration 0 - 150 psi, 0 - 10 bar
 - Gauge head with built-in pressure relief valve for quickly repeating test of oil pressure without removing gauge
 - Quick-connect coupler for easy and secure connection
 - 51" flexible hose allows easy access hard-to-reach places
 - Includes 90° coupling adapter and replacement seals
 - 10 screw adapters: R 1/8" DIN 2999, 1/8" x 27 NPT, 1/4" x 18 NPT, 3/8" x 20 UNF, 1/2" x 20 UNF, M10 x 1.0, M12 x 1.5, M14 x 1.5, M16 x 1.5, M18 x 1.5
 - Applications: Alfa Romeo, Audi, BMW, Citroën, Daihatsu, Fiat, Ford, Honda, Hyundai, Isuzu, Jaguar, Lada, Lancia, Mazda, Mercedes-Benz, Mitsubishi, Nissan, Opel, Peugeot, Renault, Rover, Saab, Skoda, Subaru, Suzuki, Toyota, Vauxhall, VW, Volvo, Zastava etc.

BLOW CASE: W380 x D310 x H80 (mm)

3PCS
Cooling System Vacuum Purge & Refill Kit



- ITEM NO.** JGAI0302 **5 (SET)**
- Check the leakage of original radiator cap and cooling system
 - Easy reading 2" diameter pressure gauge with dual scale reading of -76 - 0 cmHg and -1 - 0 bar
 - Vacuum leakage test for easy identification and prevent coolant spillage and wastage
 - Eliminates the introduction of bubbles and airlock into cooling system and deduct the time for refilling coolant
 - Kit includes a pressure gauge, connector, universal rubber cone-shape adapter, cooling hose and air bleeding hose
 - Applications: Almost all type of vehicles

BLOW CASE: W390 x D330 x H100 (mm)



Oil Pressure Tester Kit

18PCS

Universal Radiator Pressure Tester Kit



ITEM NO. JGAI1802

4 (SET)

- Check the leakage of original radiator cap and cooling system
- Hand pressure pump and leakage testing adapters made of hard and durable Nylon 66 material (PA66)
- Large and easy reading 2-1/2" diameter pressure gauge with protective rubber sleeve
- Pressure Range: 0 - 35 psi, 0 - 2.5 bar with pressure relief valve and quick coupler
- Color coded radiator leakage testing adapters for easy identification
- Kit includes a pressure testing pump with gauge, a thermometer needle, 13 radiator kits, 2 connectors and an adapter handle
- Applications: VW, Audi, Volvo, Saab, Mercedes-Benz, BMW, Renault, Porsche, Jaguar, Mitsubishi, Mazda, Toyota, Honda, Suzuki, Isuzu, Ford, GM, Chrysler, Fiat, Alfa Romeo, Lexus, Opel, Peugeot, Jeep, Land Rover, Citroën and etc.

BLOW CASE: W470 x D405 x H110 (mm)

28PCS

Universal Radiator Pressure Tester & Vacuum Type Cooling System Kit



ITEM NO. JGAI2801

2 (SET)

- Check the leakage of original radiator cap and cool system
- Hand pressure pump and leakage testing adapters made of hard and durable Nylon 66 material (PA66)
- Large and easy reading 2-1/2" pressure gauge and 2" vacuum pressure gauge
- Pressure range: 0 - 35 psi / 0 - 2.5 bar
- Vacuum pressure range: -76 - 0 cmHg / -1 - 0 bar
- Specially included vacuum purge & refill kit for easy identification and prevent coolant spillage and wastage
- Color coded radiator leakage testing adapters for easy identification
- Kit includes a pressure testing pump with gauge, vacuum pump, a thermometer needle, 20 radiator kits, 2 connectors, adapter handle, universal cone-shape adapter, coolant hose and exhaust hose
- Applications: VW, Audi, Volvo, Saab, Mercedes-Benz, BMW, Renault, Porsche, Jaguar, Mitsubishi, Mazda, Toyota, Honda, Suzuki, Isuzu, Ford, GM, Chrysler, Fiat, Alfa Romeo, Lexus, Opel, Peugeot, Jeep, Land Rover, Citroën and etc.

BLOW CASE: W600 x D510 x H110 (mm)

Curved Hose Clamp Pliers

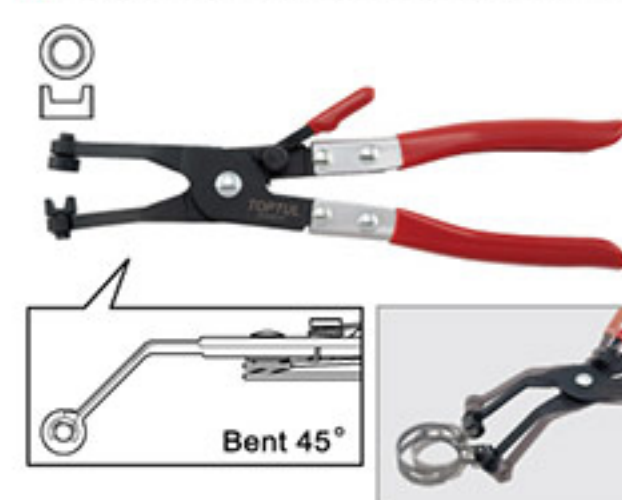

- Finger tip "position lock" design for easy replacement of lower radiator hose
- 45° bending design to fit clamps in deep position

ITEM NO.	LENGTH (mm)	W	H
JDAM039C	235 (9-1/4")	6	48

Straight Tip Lock Ring Pliers



- Used to spread snap rings found on brakes, pedal shaft, transmissions, clutch shafts, machine tools, and some piston rings
- Jaws are scored on outside for secure gripping
- Drop forged alloy steel, spring loaded joint, comfort grip handle

ITEM NO.	LENGTH (mm)	SPREAD (mm)	W	H
JDAP0109	215 (8-1/2")	25 (1")	6	72

Angle Tip Lock Ring Pliers



ITEM NO.	LENGTH (mm)	SPREAD (mm)	W	H
JDAP0209	215 (8-1/2")	25 (1")	6	72

Hose Clamp Pliers



- Finger tip "position lock" design for easy replacement of lower radiator hose

ITEM NO.	LENGTH (mm)	W	H
JDAM028E	215 (8-1/2")	6	60

Flexible Hose Clamp Pliers

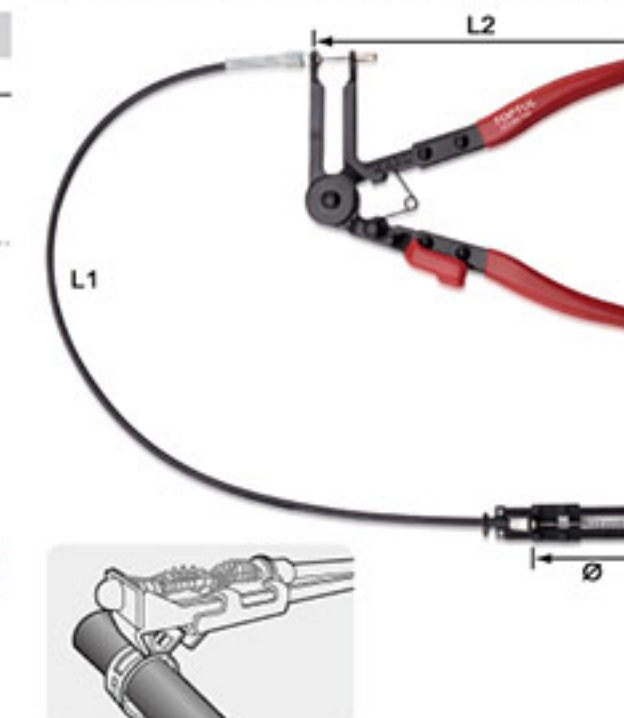

- For replacement of fuel, oil and water hose
- Hose clamp with flexible 630mm wire
- Suitable to work in hidden areas and long distance

ITEM NO.	L1 (mm)	L2 (mm)	Max. Ø (mm)	W	H
JDAM0163	630	225	53	12	36

3PCS

Flexible Line Clamp Set



ITEM NO.	CONTENTS	W	H
JGAR0301	1 JDAY0119 Small Line Clamp Ø6 - 19mm (1/4" - 3/4") 1 JDAY0132 Medium Line Clamp Ø13 - 32mm (1/2" - 1-1/4") 1 JDAY0157 Large Line Clamp Ø19 - 57mm (3/4" - 2-1/4")	10 (SET)	

3 Way Hose Clamp Tool



- Designed for releasing and refitting most of spring hose clamp
- For use with 14mm wrench or 1/4" square drive tools
- Suitable for using in confined space

ITEM NO.	CAPACITY (mm) A	CAPACITY (mm) B	L (mm)	W	H
JDAM0436	1.5 - 35	6.5 - 40	80	10	100
JDAM0460	1.5 - 60	6.5 - 65	105	10	100

Fuel Line Connector Pliers



- Perfect tool for releasing connections on fuel pipes during engine service or when replacing fuel filters
- Specially made tip pliers is designed to compress the quick connect lugs for easy removal without damaging the connectors
- Made of high grade hardened tool steel
- Ergonomic comfort-grip handle
- Applications: VW, Audi, Fiat, GM, Opel, Vauxhall, Mercedes-Benz and etc.

ITEM NO.	LENGTH (mm)	W	H
JDBY0109	230 (9")	6	48

4PCS
Steel Line Stopper Set



- Expert quality, use on brake and fuel supply lines to prevent fluid leaks and contamination during service
- Spring loaded design for easy and fast operation
- Specifications: Banjo, 5/16" (8mm), 3/8" (9.5mm), and 1/2" (12.7mm)

ITEM NO.	CONTENTS		
JGAR0401	1 JDBZ0101 Banjo Line Stopper		
	1 JDBZ0102 1/2" (12.7mm) Line Stopper	24	48
	1 JDBZ0103 3/8" (9.5mm) Line Stopper		
	1 JDBZ0104 5/16" (8mm) Line Stopper		

3-Jaw Fuel Gauge & Pump Sender Collar Wrench



- Made of Chrome Molybdenum Alloy Steel
- Ideal for removing and fitting fuel gauge sender collars to avoid damage
- 3 jaws design to ensure holding power while decrease risk of damage the plastic collar
- Use with a 16mm wrench or socket
- Suitable for most collar from 89 to 170mm

ITEM NO.	CAPACITY Ø (mm)		
JDCB0117	89 - 170	1	12

Steel Line Stopper Set (Twin Pack)



- Expert quality, use on brake and fuel supply lines to prevent fluid leaks and contamination during service
- Spring loaded design for easy and fast operation
- Heavy-duty construction for the strength and durability
- 4 in 1 design: Suitable for Banjo, 5/16" (8mm), 3/8" (9.5mm), and 1/2" (12.7mm)

ITEM NO.	CONTENTS		
JGAR0203	2 JDBZ0201 4 IN 1 Steel Line Stopper	10	80

Valve Spring Compressor



- Reversible jaw adapter for multi-valve engines
- Dual size in adapter 25mm & 30mm adapter

ITEM NO.	CAPACITY (mm)		
JGAN0143	35 - 200	3	6

Valve Spring Compressor Kit (One Man Operation Type)

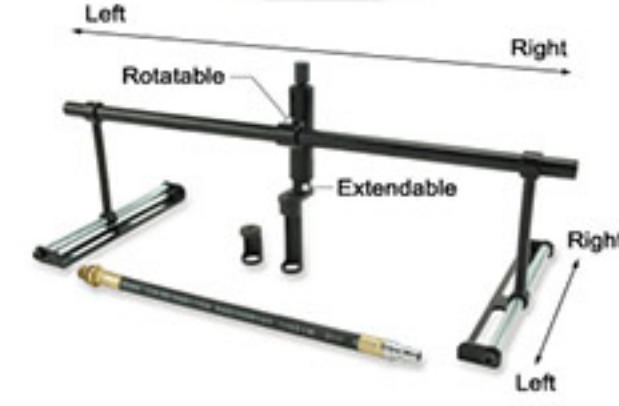

ITEM NO.	JGAN0222	5 (SET)
----------	----------	---------

- Easy for single use, operated by a thread bar to fix on right place
- Recessed pocket on valve pusher allows replacement retrieval of valve collets
- Complete service tool kit for installation and removal of the valve spring without removing the cylinder head from the engine
- Valve pusher size: Ø 22 mm
- Application: 12V, 16V, 20V, 24V engine

BLOW CASE: W570 x D240 x H60 (mm)

7PCS
Valve Spring Compressor Kit

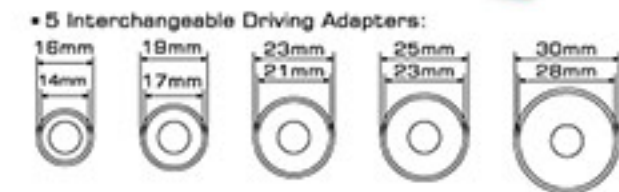

- 5 Interchangeable Driving Adapters: 16mm, 18mm, 23mm, 25mm, 30mm
- This tool kit is designed to compress and release valve spring after removing the collets
- Arched-type steel tube lever ensures a consistent coaxial contact with the valve
- Includes 5 interchangeable driving adapters to fit valve springs: 16mm, 19mm, 23mm, 25mm, 30mm
- Driving adapters are made of heat treated Chrome Molybdenum Steel
- 2 Length pressure screws: 50mm & 90mm
- Ideal to use on cars, motorcycles and small bore engines applications
- Hand-operated tool kit

ITEM NO.	CAPACITY (mm)	THROAT DEPTH (mm)	(SET)
JGAI0702	30 - 130	100	12

BLOW CASE: W340 x D195 x H50 (mm)

Valve Stem Seal Pliers

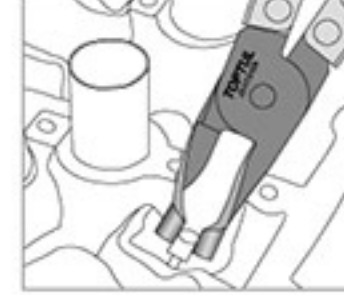

- High quality metal Seal Removal Tool removes valve stem seals from overhead camshaft engines
- Valve pliers reach down around the valve stem into the confined area of the seal for easy removal
- Gripping serration in the pliers tip easily grabs both original equipment and aftermarket seals regardless of their configuration
- Jaws are serrated for a secure grip on the seal

ITEM NO.	LENGTH (mm)		
JDAT0109	248 (9-3/4")	6	48
JDAT0110	274 (10-25/32")		

3PCS
Engine Cylinder Hone Replacement Stone Set



- For general purpose honing and glaze breaking
- Silicon carbide grinding stones bonded to holders
- Set includes 3pcs stones and cotter pins

ITEM NO.	STONE DIMENSION	GRIT SIZE		
JLAF2201	1-1/8"(L) x 13/64"(W)	# 220	25	200
JLAF1804	4"(L) x 13/32"(W)	# 180	25	200

Angular Torque Gauge



- Full circle 360° angle scale. Clearly marked in 2 degree increments & in intervals of 10 & 30 degrees
- Adjustable arm keeps angle gauge scale stationary, wedge it against object while turning drive tool
- Accommodates 1/2" male and female square drive

ITEM NO.	DRIVE (inch)	Ø (mm)		
JDAW1602	1/2" (F) x 1/2" (M)	68	12	48

2PCS
Valve Grinder Set



- For hand grinding flat head, unslotted valves
- Synthetic rubber vacuum cups are resistant to oil, grease and gasoline
- 2 pieces in blister card packing

Place grinding compound on valve face and put in seat. Put suction cup on valve head and turn handle between hands to grind.

ITEM NO.	CONTENTS		
JGAR0201	1 JDBQ2026 Valve Grinder Tool Cup diameters: 5/8", 13/16" (for smaller valves)	12	108
	1 JDBQ3644 Valve Grinder Tool Cup diameters: 1-1/8", 1-3/8" (for larger valves)		

3-Leg Engine Cylinder Hone

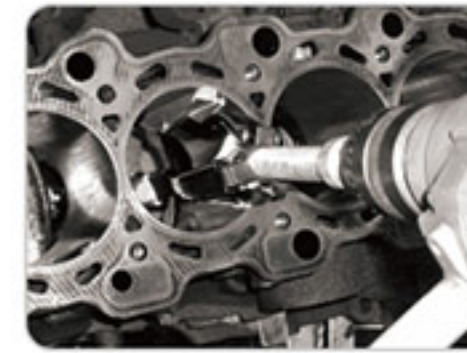

- Suitable to use with standard 1/4" or any electric drill. Use appropriate fluid for cutting lubricant. Interchangeable honing
- Designed for general purpose honing and glaze breaking of cylinders, bearing, bores and pipes
- Spread limiter and adjustable spring provide easily insert hone into cylinder, automatic center and wall alignment for full stone contact with cylinder walls
- Supplied complete with 3pcs grit stones
- Application: Automotive brake and clutch cylinders, engine cylinders of motorcycles, lawn mowers, outboard motors, hydraulic cylinders, machine and industrial engines and etc.

ITEM NO.	CAPACITY	GRIT SIZE	L (mm)		
JDBE0322	Ø 7/8" - Ø 2-3/4"	# 220	190 (7-1/2")	25	100
JDBE0718	Ø 2" - Ø 7"	# 180	300 (12")	10	40

Angular Torque Gauge



- Full circle 360° angle scale. Clearly marked in 2 degree increments & in intervals of 10 & 20 degrees
- With magnetic holder on the flexible reaction arm for the fixing point. Easier to anchor to the engine and keeps angle scale stationary
- Accommodates 1/2" male and female square drive

ITEM NO.	DRIVE (inch)	Ø (mm)	L (mm)		
JDAW1601	1/2" (F) x 1/2" (M)	63	480	15	30

7PCS
Diesel Injector Seat Cutter Set



- Specially designed for cleaning and re-cutting injector seats for all common rail diesel engines
- To avoid "blow-by" occurring cause of possible build-up of carbon deposits and corrosion
- Application for all modern common rail diesel engines

ITEM NO.	CONTENTS	10 (SET)
JGAI0704	T-Handle Socket Wrench 19 mm	
	Pilot Post	
	Flat Reamer 15 x 19, 17 x 17, 17 x 19 mm	
	Angled Reamer 17 x 21 mm	
	Hex Key Wrench 2.5 mm	
BLOW CASE: W217x D165 x H50 (mm)		

Diesel Injector Puller Tool Set



- Designed for quick and easy removal of stubborn diesel injectors
- Suitable for Bosch & Lucas type diesel injectors
- Slide hammer mechanism completed with M8, M12/M14 adapters
- Includes M17 adapter for GM Vauxhall / Opel injectors (X20DTH / Y20DTH series engines)

ITEM NO.	CONTENTS	10 (SET)
JGAI0101	Slide Hammer Assembly	
	M8 x 0.75 Adapter	
	M12 x 1.5 & M14 x 1.5 Adapter	
	M17 x 0.75 Adapter	
BLOW CASE: W292x D116 x H57 (mm)		

Oil Screw Socket (M16H)

CR-V



- Made of Chrome Vanadium Alloy Steel
- For removing and installing of the gearbox drain plug
- Operated by 17mm wrench or socket
- Applicable: Audi, VW, VW Passat, Porsche Boxster and etc.

ITEM NO.	SIZE (mm)	SIZE (mm)	L (mm)	10	180
JDBB1617	17	M16H	38	10	180

1/2" DR. Oil Drain Plug Socket

SNCM+V



- Made of expert quality, hardened and tempered Chrome Molybdenum Steel material
- A special 12 point (triple square) tamperproof socket used to remove the transmission drain plug
- Tamperproof design for removing and installing the oil release bolts/screws on the transmission and gearbox
- Application: Audi A4-A6, VW Passat, Porsche Boxster and etc.

ITEM NO.	DRIVE	SIZE (mm)	L (mm)	10	60
JDBC1616	1/2"	M16H	60	10	60

14PCS
3/8" DR. Master Oil Drain Plug Key Set

CR-V



- Popular keys for draining differentials, sumps, axles and gearboxes on most modern vehicles
- Drain plug keys made of hardened and tempered Chrome Vanadium Steel
- Suitable for use with 3/8" square drive tools
- Applications: BMW, Citroen, Fiat, Ford, Honda, Lancia, Mazda, Nissan, Mercedes-Benz, Peugeot, Renault, Toyota, Volvo, VW and etc.

ITEM NO.	CONTENTS	25 (SET)
JGAI1402	JDBF1208-1217 3/8" Dr. Oil Drain Plug Hexagon Key 8, 9, 10, 12, 14, 17 mm	
	JDBH1207-JDBH1213 3/8" Dr. Oil Drain Plug Square Key 7, 8, 11, 13 mm	
	JDBJ1210 & 1212 3/8" Dr. Oil Drain Plug Square Key 5/16" & 3/8"	
	JDBK1210 3/8" Dr. Oil Drain Plug Female Square Key 10 mm	
	JDBL1210 3/8" Dr. Oil Drain Plug Triangle Key 10 mm	
BLOW CASE: W220 x D90 x H47 (mm)		

14PCS
Master Oil Drain Plug Key Set

CR-V



- Popular keys for draining differentials, sumps, axles, gearboxes on most modern vehicles
- Drain plug keys made of hardened and tempered Chrome Vanadium Steel
- Suitable for use with 17mm wrenches or sockets
- Black phosphate finished
- Applications: BMW, Citroen, Fiat, Ford, Honda, Lancia, Mazda, Nissan, Mercedes-Benz, Peugeot, Renault, Volvo, VW and etc.

ITEM NO.	CONTENTS	15 (SET)
JGAI1403	JDCF1708-1717 Oil Drain Plug Hexagon Key 8, 9, 10, 12, 14, 17 mm	
	JDCG1712 Oil Drain Plug Hexagon Key 3/8"	
	JDCH1708-1713 Oil Drain Plug Square Key 8, 9, 10, 11, 12, 13 mm	
	JDCM1716 Oil Drain Plug Triple Square Tamperproof Key M16H	
BLOW CASE: W252x D120 x H40 (mm)		

Oil Service Wrench

CR-V



- Chrome Vanadium Steel Material
- Bent, size 8mm and 10mm outside male square
- Suitable for the removal of oil drain and filler plug on gearbox, sump and differential
- Applications: Citroen, Peugeot, Renault and etc.

ITEM NO.	SIZE (mm)	L (mm)	10	40
JEL-0810	8 x 10	230	10	40

Strap Wrench



- Special-purpose oil filter strap wrench
- One piece forged construction for maximum strength and durability
- Rubber coated on the strong woven strap to prevent slipping
- Perfect use for polished pipes, plastic pipes and fittings against with scratch damage or deformation

ITEM NO.	CAPACITY (mm)	L (inch)	10	60
JJAH0902	30 - 160	9	10	60
JJAH1102	60 - 260	11	12	36

Oil Filter Chain Wrench



- Removes any oil filters up to 4-11/16" (120mm) diameter
- Chain style enables to grips oil filter tightly
- Use with 1/2" square drive tools or 13/16" (21mm) wrench

ITEM NO.	MAX. CAPACITY (mm)	12	72
JDDA1612	120 (4-11/16")	12	72

Heavy Duty Chain Wrench



- Heavy duty heat treated chain
- Chrome Molybdenum Steel handle
- Serrated jaws allows sure ratcheting action in either direction
- Long steel handle for added leverage
- Cushioned soft grip allows a better grip and less hand fatigue
- Ideal for filter removal, turning larger pipes and holding pulleys

ITEM NO.	GRIPPING CAPACITY (mm)	CHAIN LENGTH (inch)	HANDLE LENGTH (inch)	20	10
JJAH1203	13 - 152 (1/2" - 6")	20	12	20	
JJAH2003	76 - 172 (3" - 6-3/4")	24-1/2	20	10	

Nylon Strap Oil Filter Wrench



- Removes any oil filters up to 6" (152mm) diameter
- Strong, non-slip nylon webbing strap
- Use with 1/2" square drive tools

ITEM NO.	MAX. CAPACITY (mm)	12	72
JDAV1615	152 (6")	12	72

Nylon Strap Oil Filter Wrench



- Removes any oil filters up to 12" (300mm) diameter
- Strong, non-slip nylon webbing strap
- Use with 3/8" or 1/2" square drive tools

ITEM NO.	MAX. CAPACITY (mm)	10	40
JDAV1630	300 (12")	10	40

Chain Wrench



ITEM NO.	CAPACITY (mm)	L (inch)	25	50
JJAH0901	30 - 160	9	25	50

Chain Wrench



- Tempered and hardened high-grade tool steel chain and body
- Double-hinge construction for high clamping power
- Ratchet-style action design works in both directions
- Flexible handle enables to work in narrow spaces
- Non-slip, comfort plastic coating handles
- Ideal for automotive oil filter replacement
- Handle length: 230mm (9")

ITEM NO.	CAPACITY (mm)	Chain Length (mm)	6	24
JDBA60A5R	60 - 105	350 (14")	6	24
JDBA60G0R	60 - 160	520 (20-1/2")	6	24

Oil Filter Master Pliers

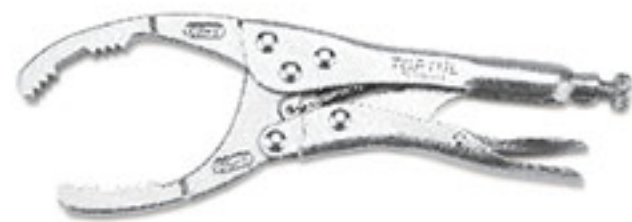

- High quality Chrome Vanadium Alloy Steel
- Professional heat treated and machined
- Adjustable locking pliers design filter wrench
- Nickel plated finish
- Jaws Opening Range: 2-1/8" to 4-5/8" (53mm - 118mm)

ITEM NO.	SIZE (inch)	12	48
DMAC1A10	10		

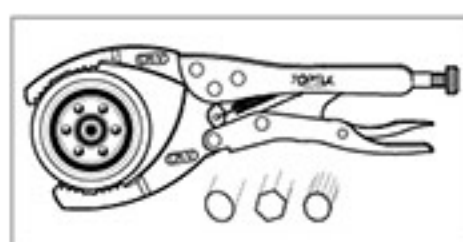

Multi-Purpose Pliers
Suitable for installing, removing and tightening objects of any shape.

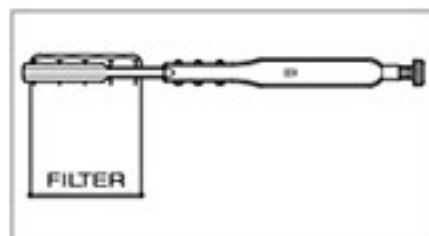

This pliers can be adjusted and fastened for applications at any angle.

Oil Filter Pliers



- Drop forged pliers body for strength
- 3-position slip-joint design
- Serrated jaws and long handles for extra grip

ITEM NO.	SIZE (inch)	CAPACITY Ø (mm)	10	40
JDA1010	10	60 - 90 (2-3/8" - 3-1/2")		
JDA1212	12	57 - 110 (2-1/4" - 4-5/16")		

Metal Strap Oil Filter Wrench



- Band type filter wrench, adjustable by turning knob
- Steel strap with light, heavy duty Aluminum Alloy body and die-cast control knob
- Removes filters with minimal risk of damage
- Ideal for automotive oil filter replacement
- Suitable for one-hand operation in areas of restricted access

ITEM NO.	CAPACITY Ø (mm)	MAX. LENGTH (mm)	10	50
JDAZ65B0	65 - 110	290		

Professional Swivel Handle Oil Filter Wrench



- Heavy duty oil filter wrench
- Swivel handle allows user to reach filters in hard to reach places
- Wide band securely grips filters without crushing
- Easy grip comfortable handle

ITEM NO.	CAPACITY Ø (mm)	6	36
JDAU6073	60 - 73 (2-3/8" - 2-7/8")		
JDAU7385	73 - 85 (2-7/8" - 3-3/8")		
JDAU8595	85 - 95 (3-3/8" - 3-3/4")		
JDAU95B0	95 - 110 (3-3/4" - 4-3/8")		

Two Way Oil Filter Wrench



- Remove oil filters from 66 - 94mm diameter
- Use with 3/8" square drive tool or 17mm wrench

ITEM NO.	CAPACITY Ø (mm)	6	36
JDAA0808	66 - 94		

Two Way Oil Filter Wrench



- Special serrated design for easy to grip filter without slipping
- Installed springs, ideal for assisting user to hold filter quickly
- Use with 1/2" square drive tool

ITEM NO.	CAPACITY Ø (mm)	21	6	36
JDCA0108	60 - 80			
JDCA0112	80 - 115	22	1	8
JDCA0114	115 - 140	24	1	4

3-Legged Oil Filter Wrench



- Filter Capacity: 65 - 120mm (2-1/2" to 4-3/4")
- Removes all sizes of oil filters from 65 to 120mm in diameter
- Use with 1/2" or 3/8" square drive tool or 21mm wrench/socket
- Suitable for most cars and light trucks

ITEM NO.	CAPACITY Ø (mm)	12	48
JDAI65A2	65 - 120 (2-1/2" - 4-3/4")		

Cup Type Oil Filter Wrench (For 4-Cylinder TOYOTA Engines)



- Robust Aluminum Alloy Die-Casting
- For 4-cylinder petrol or diesel engines from 1.8L to 2.0L
- Designed for quickly installation and dismantling of the oil filter cover during the oil filter insert
- Multiple contact points engaged the housing cap to grip oil filter securely
- Use with 3/8" square drive tool or 27mm wrench/socket
- Application: TOYOTA-Allion, Auris, Corolla Axio, Isis, Ist, Corolla Rumion, Corolla Fielder, Noah, Premio, Prius, Voxy, Wish, etc.

ITEM NO.	SIZE (mm)	FLUTES	10	40
JDDH6500	64.5	14		

Cup Type Oil Filter Wrench (For 4-, 6- and 8-Cylinder TOYOTA Engines)



- Robust Aluminum Alloy Die-Casting
- For 4-, 6- and 8-cylinder diesel engines
- Designed for quickly installation and dismantling of the oil filter cover during the oil filter insert
- Multiple contact points engaged the housing cap to grip oil filter securely
- Use with 3/8" square drive tool or 27mm wrench/socket
- Application: TOYOTA- 2007-2008 V6, Corolla-(2007-2009) 4cyl, Tundra-(2007) 8cyl, Sequoia-(2008) 8cyl, Land Cruiser-(2008-2010) 8cyl, 4Runner-(2008-2010) 4cyl, 6cyl LEXUS- (2006)- all vehicles, (2007) ES350, GS350, GS450h, LS460, RX350, (2008) LS600h L, (2009) LX570

ITEM NO.	SIZE (mm)	FLUTES	10	40
JDDH6501	64.5	14		

Cup Type Oil Filter Wrench

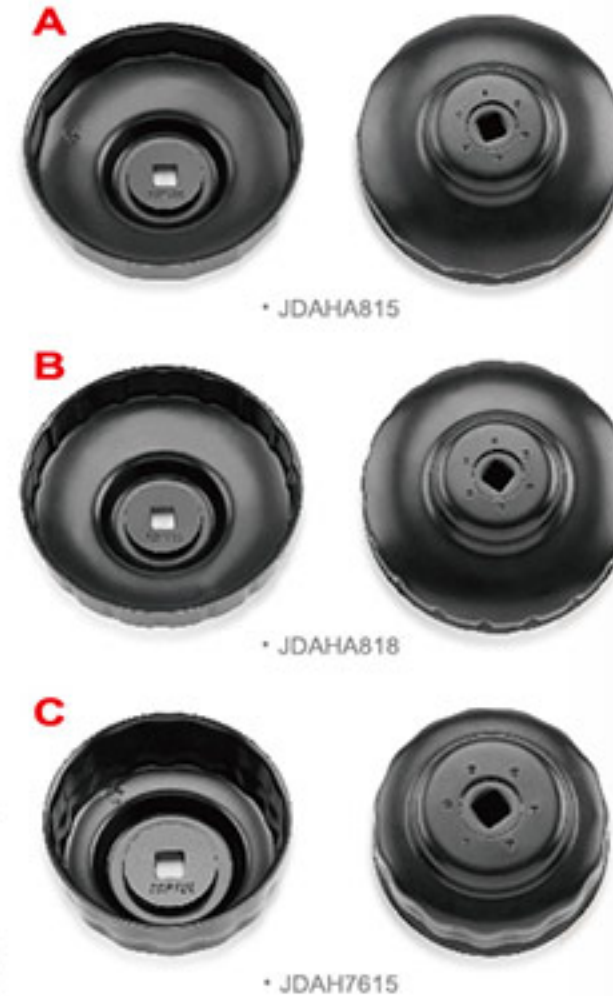

14PCS Automotive Cup Type Oil Filter Wrench Set



- TOPTUL cup-type oil filter wrenches are made of gauge construction and are able to withstand up to 85 ft-lbs of torque applied. The cup-design grip functions as a socket minimizing the possibility of crushing filters and fits both 3/8" and 1/2" (adapter) square drive tool. The cups are coated with electro-black oxide finish for long life protection against rust
- Suitable for Japanese Vehicles

ITEM NO.	CONTENTS	6 (SET)
JGAI1401	<ul style="list-style-type: none"> • 64mm (2-1/2") - 14 Flutes-1 Step • 65mm (2-9/16") - 14 Flutes-1 Step • 68mm (2-11/16") - 14 Flutes-1 Step • 73mm (2-7/8") - 14 Flutes-1 Step • 74mm (2-29/32") - 15 Flutes-1 Step • 74 - 76mm (2-29/32 - 3") - 15 Flutes-2 Step • 76mm (3") - 30 Flutes-1 Step • 75 - 77mm (2-15/16 - 3-1/32") - 15 Flutes-2 Step • 80mm (3-9/64") - 15 Flutes-1 Step • 90mm (3-17/32") - 15 Flutes-1 Step • 93mm (3-21/32") - 15 Flutes-1 Step • 93mm (3-21/32") - 36 Flutes-1 Step • 100mm (4") - 15 Flutes-1 Step • Adapter - 1/2"(F) x 3/8"(M) Drive 	
BLOW CASE: W415x D264 x H81 (mm)		



TYPE	ITEM NO.	SIZE (mm)	FLUTES	12	72
	JDAH6414	64 (2-1/2")	14		
	JDAH6514	65 (2-9/16")	14		
	JDAH6814	68 (2-11/16")	14		
	JDAH7314	73 (2-7/8")	14		
	JDAH7415	74 (2-29/32")	15		
	JDAH7608	76 (3")	8		
	JDAH7614	76 (3")	14		
A	JDAH8015	80 (3-9/64")	15		
	JDAH8616	86 (3-3/8")	16		
	JDAH9015	90 (3-17/32")	15		
	JDAH9210	92 (3-40/64")	10		
	JDAH9315	93 (3-21/32")	15		
	JDAHA015	100 (4")	15		
	JDAHA615	106 (4-11/64")	15		
	JDAHA815	108 (4-8/32")	15		
	JDAH6606	66 (2-19/32")	6		
	JDAH7612	76 (3")	12		
	JDAH7630	76 (3")	30		
B	JDAH8618	86 (3-3/8")	18		
	JDAH9336	93 (3-21/32")	36		
	JDAH9345	93 (3-21/32")	45		
	JDAH9618	96 (3-3/4")	18		
	JDAHA818	108 (4-8/32")	18		
	JDAH7615	74 - 76 (2-29/32" - 3")	15		
C	JDAH7715	75 - 77 (2-15/16 - 3-1/32")	15		

16PCS Automotive Cup Type Oil Filter Wrench Set



- Suitable for European Vehicles

ITEM NO.	CONTENTS	5 (SET)
JGAI1601	<ul style="list-style-type: none"> • 66mm (2-19/32") - 6 Flutes-1 Step • 74 - 76mm (2-29/32" - 3") - 15 Flutes-2 Step • 76mm (3") - 8 Flutes-1 Step • 76mm (3") - 12 Flutes-1 Step • 76mm (3") - 14 Flutes-1 Step • 86mm (3-3/8") - 16 Flutes-1 Step • 86mm (3-3/8") - 18 Flutes-1 Step • 92mm (3-40/64") - 10 Flutes-1 Step • 93mm (3-21/32") - 15 Flutes-1 Step • 93mm (3-21/32") - 45 Flutes-1 Step • 96mm (3-3/4") - 18 Flutes-1 Step • 106mm (4-11/64") - 15 Flutes-1 Step • 108mm (4-8/32") - 15 Flutes-1 Step • 108mm (4-8/32") - 18 Flutes-1 Step • 3-Legged Oil Filter Wrench - 65 to 120mm (2-1/2" - 4-3/4") • Adapter - 1/2"(F) x 3/8"(M) Drive 	
BLOW CASE: W446 x D318 x H90 (mm)		



BMW VANOS Unit Sprocket Extractor / Installer

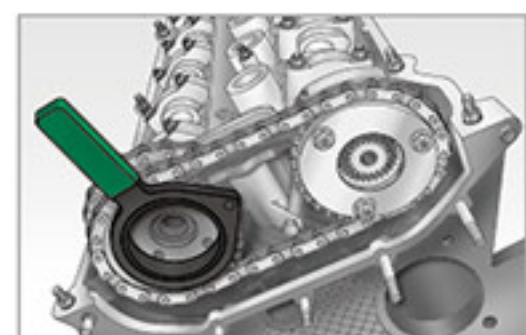

- Suitable for the BMW twin camshaft engines M42, M44, M50, M52, S50 and S52 with VANOS unit
- For turning sprockets when removing and installing VANOS Unit

ITEM NO.	L (mm)	12	48
JDDP1765	170		

TOPTUL
AUTO TOOLS - Engine Series

8PCS BMW Engine Timing Tool Set

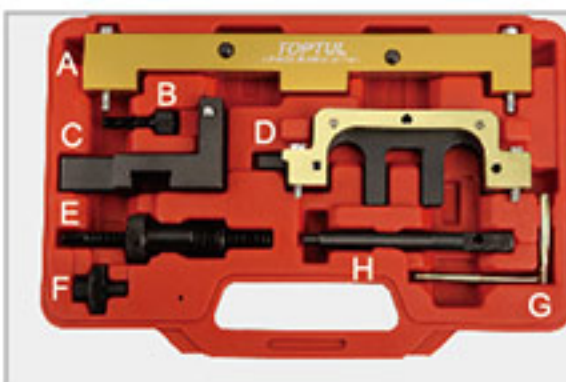

ITEM NO. JGAI0803 10 (SET)

- A specific tool set for adjustment and arresting of twin camshaft on petrol engine
- Suitable for checking and adjustment of camshaft timing
- Removal, installation and alignment of VANOS Units
- Application:
BMW 118i E81/82/87/88 (04-12) / 120i E81/82/87/88 (04-12) / 316i Compact E46 (01-07) / 318i E90/91/92/32 (05-12) / 318i Compact E46 (01-07) / 320i E90/91/92/93 (05-12) / 520i E60/61 (07-10) / X1 sDrive 18i E84 (10-12) / X1 xDrive 18i E84 (10-12) / X3 2.0 E83 (05-10) / Z4 2.0 E85/86 (04-09)
- Engine Code:
N42/N46/N46T-B18, B18A, B20, B20A, B20B, B20BD, B20BZ, B2O2

BLOW CASE: W330 x D235 x H50 (mm)

Part No.	Description	Q'ty
A	Vanos Alignment Plate	1
B	Camshaft Setting Plate Securing Screw	1
C	Camshaft Setting Plate (Inlet)	1
D	Camshaft Setting Plate (Exhaust)	1
E	Timing Chain Tensioner Pre-Load Tool	1
F	Camshaft Turning Tool	1
G	Flywheel TDC Locking Pin	1
H	Crankshaft Alignment Pin	1

18PCS BMW Engine Timing Tool Set

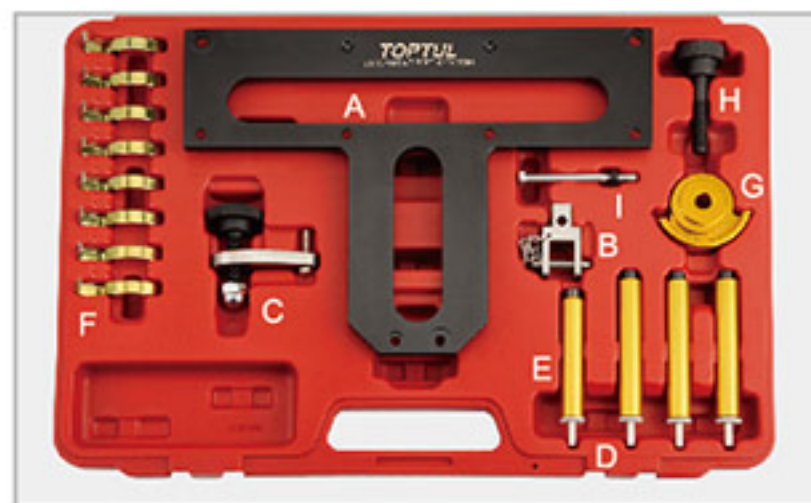

ITEM NO. JGAI1803 5 (SET)

- A specific tool set for adjustment and arresting of twin camshaft on petrol engine
- Suitable for installing and removal of inlet camshaft and carrier assembly
- Removal, installation and replacement of VANOS Units
- Use with TOPTUL JGAI0803 (8pcs BMW Engine Timing Tool Set)
- Application:
BMW 118i E81/82/87/88 (04-12) / 120i E81/82/87/88 (04-12) / 316i Compact E46 (01-07) / 318i E90/91/92/32 (05-12) / 318i Compact E46 (01-07) / 320i E90/91/92/93 (05-12) / 520i E60/61 (07-10) / X1 sDrive 18i E84 (10-12) / X1 xDrive 18i E84 (10-12) / X3 2.0 E83 (05-10) / Z4 2.0 E85/86 (04-09)
- Engine Code:
N42/N46/N46T-B18, B18A, B20, B20A, B20B, B20BD, B20BZ, B2O2

BLOW CASE: W450 x D320 x H55 (mm)

Part No.	Description	Q'ty
A	Camshaft / Carrier Bracket Mounting Fixture	1
B	Torsion Spring Remover / Installer	1
C	Inlet Camshaft Securing Tool (Rear)	1
D	Mounting Fixture Support - Long	3
E	Mounting Fixture Support - Short	1
F	Intermediate Lever Clamp Set	8
G	Inlet Camshaft Securing Tool (Front)	1
H	Inlet Camshaft Securing Tool (Front) Lock	1
I	Bolt and Nut	1

5PCS BMW Engine Timing Tool Set

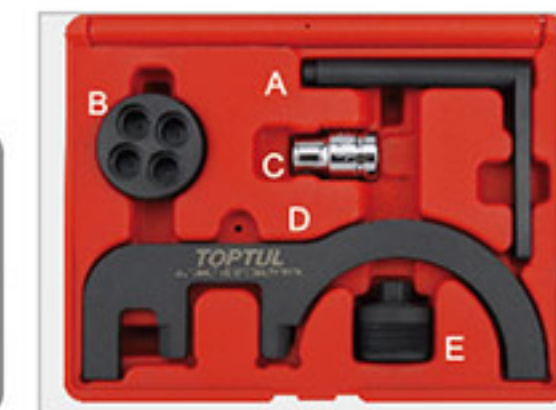
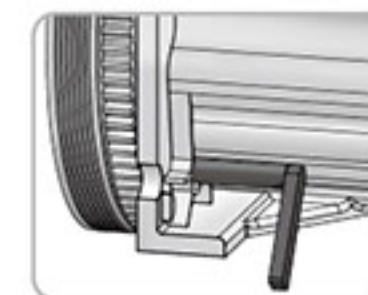
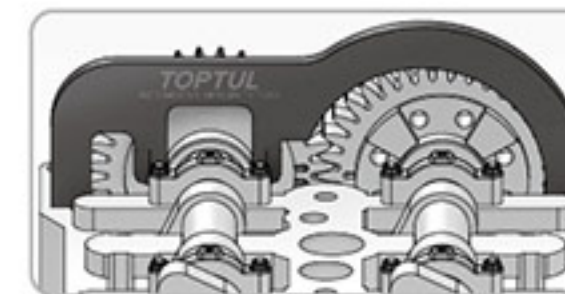

Part No.	Description	Q'ty
A	Flywheel Locking Pin	1
B	Crankshaft Turning Tool	1
C	1/2" DR. Hex Socket	1
D	Camshaft Setting Plate	1
E	HP Pump Sprocket Retaining Tool	1

ITEM NO. JGAI0501 10 (SET)

- A specific tool set for adjustment and arresting of twin camshaft on diesel engines
- Suitable for checking and adjustment of camshaft timing
- Pump pulley removal tool included
- Application:
BMW: 116d E81/82/87/88 (08-12) / 118d E81/82/87/88 (07-14) / 120d E81/82/87/88 (07-14) / 123d E81/82/87/88 (07-14) / 316d E90/91/92/93 (09-12) / 318d E90/91/92/93 (07-12) / 320d E90/91/92/93 (07-12) / 325d E90/91/92/93 (10-14) / 330d / xd E90/91/92/93 (08-14) / 520d E60/61 (07-10) / 525d F10/11 (10-12) / 530d F10/11 (10-13) / 530dGT F07 (09-12) / 535d F10/11 (10-12) / 535dGT F07 (10-12) / 730d/Ld F01/02/04 (08-12) / 740d F01/02/04 (09-12) / 740d xDrive F01/02/04 (09-12) / X1 sDrive 18d E84 (09-12) / X1 sDrive 20d E84 (09-12) / X1 xDrive 18d E84 (09-14) / X1 xDrive 20d E84 (09-12) / X1 xDrive 23d E84 (09-12) / X3 2.0d E83 (07-10) / X3 xDrive 18d E83 (08-10) / X3 xDrive 30d E83 (11-12) / X5 3.0d E70 (10-12) / X5 xDrive 40d E70 (10-13) / X6 xDrive 30d E71/72 (10-14) / X6 xDrive 40d E71/72 (10-14)
- Mini: Clubman (10-14) / Clubvan (12-14) / Countryman (10-14) / Mini (10-14) / Paceman (13-14) / Roadster (12-14)
- Engine Code: N47/N47S-C16K1, C16U1, C20K1, C20U1, D20A, D20B, D20O0, D20T0, D20U0 / N57-D30O0, D30O1, D30T0, D30U0

BLOW CASE: W216 x D165 x H51 (mm)

10PCS Mini / PSA Engine Timing Tool Set

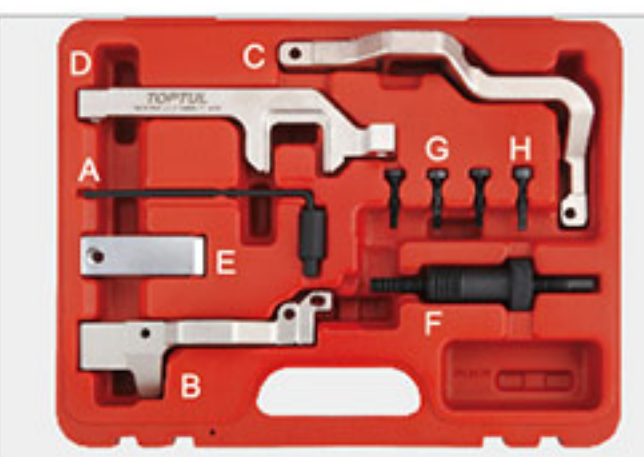

ITEM NO. JGAI1004 5 (SET)

- A specific tool set for adjustment and arresting of twin camshaft petrol engine
- Suitable for checking and adjustment of camshaft timing
- Removing, installing and replacement of VANOS Units
- Application:
Mini: Mini One R56 (07-10) / Mini R56/R57 (07-15) / Cooper R55 (06-10) / Cooper R56 (07-10) / Cooper S R55/R56 (06-10) / Clubvan R55 (12-14) / Clubvan R60 (12-14) / Clubman R55 (10-14) / Clubman R60 (10-14) / Countryman R55 (07-10) / Countryman R60 (10-16) / R58 Coupe (11-15) / R59 Roadster (12-15) / Roadster R61 (13-15) / Paceman R61 (13-16)
- Citroën: C4 (08-11) / C4 Picasso (08-13)
- Peugeot: 207 (06-11) / 207CC (07-14) / 308 (07-14) / 3008 (09-14) / 5008 (09-14)
- Engine Code:
Mini: N12 / N14 / N16
Citroën / Peugeot: EP3 (8FS) / EP3C (8F01) / EP6 (5FW) / EP6C (5F01) / EP6CDT (5F04) / EP6DT (5FT/5FX) / EP6DTS (5FY)

BLOW CASE: W328 x D268x H72 (mm)

Part No.	Description	Q'ty
A	Flywheel Locking Pin	1
B	Exhaust Camshaft Setting Tool	1
C	Inlet Camshaft Setting Tool (N12 / N16 / EP3 / EP6)	1
D	Inlet Camshaft Setting Tool Assembly E (N14 / EP6DT / DTS)	1
E	Inlet Camshaft Setting Tool Assembly D (N14 / EP6DT / DTS)	1
F	Timing Chain Tensioner Pre-Load Tool	1
G	Socket Head Screws	3
H	Screw Bolt	1

12PCS VW / Audi Diesel Engine Timing Tool Set

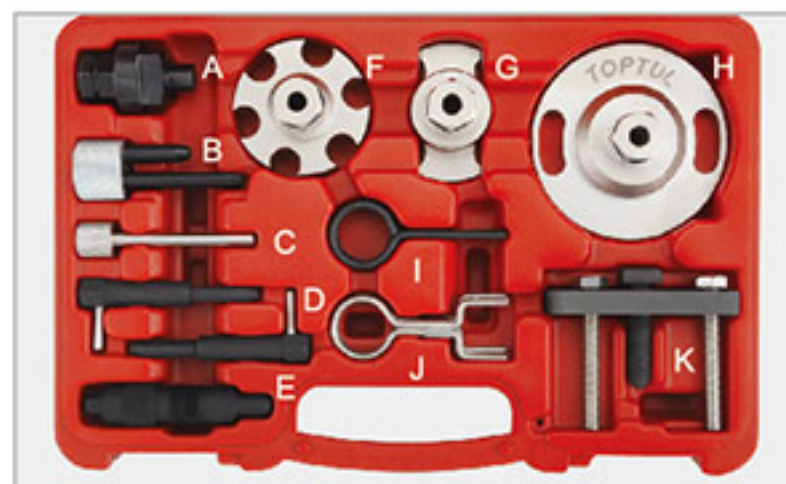

Part No.	Description	Q'ty
A	Crankshaft Adjuster	1
B	H.P. Pump Locking Pin	1
C	Balance Shaft Locking Pin	1
D	Camshaft Locking Pin	2
E	Crankshaft Locking Pin	1
F	Camshaft Adjuster	1
G	Camshaft Sprocket Adjuster	1
H	Crankshaft Adjuster	1
I	Tensioner Retaining Pin	4
J	Tensioner Retaining Pin	3
K	H.P. Pump Sprocket Remover	1

ITEM NO. JGAI1203 **10 (SET)**

- A specific tool set for adjustment and arresting of timing chain on VW / Audi diesel engines
- Suitable for position engine shafts such as camshafts, injection pump shafts and crankshafts
- Application: VW Group 2.7/3.0 TDI V6 & 4.0/4.2 TDI V8 Diesel engine in: Audi- A4/ A5/ A6/ A6 Allroad/ A8/ Q5/ Q7 VW - Phaeton / Touareg
- Engine Code: V6 Engines - ASB, BKN, BKS, BMK, BMZ, BNG, BPP, BSG, BUS, BUN, CAMA, CAMB, CANA, CANB, CANS, CAND, CAPA, CARA, CARB, CAGA, CASB, CASC, CATA, CCMA, CCWA, CCWB, CDYA, CDYB, CDYC, CEXA, CGKA, CGKB V8 Engines - ASE, BTR, BVN, CCFA

BLOW CASE: W300 x D207 x H62(mm)

Crankshaft Locking Tool

3PCS
Crankshaft Timing Belt Pulley Locking Tool Set



• Marking on the right of the locking screw

• Marking on the right of the locking screw

• Special design to lock the crankshafts on VW, Audi, Seat, Skoda, 2.0 TDI engine and etc.

ITEM NO.	LENGTH (mm)	50	100
JDBR2065	65	50	100

ITEM NO. JGAR0302 **5 (SET)**

- A specific engine timing tool set for Audi, VW, Seat and Skoda TDI PD and V6 engines
- Contents: Injection Pump Locking Pin, Tensioner Locking Tool, Crankshaft Locking Tool

Timing Belt Tensioner Adjustment Tool

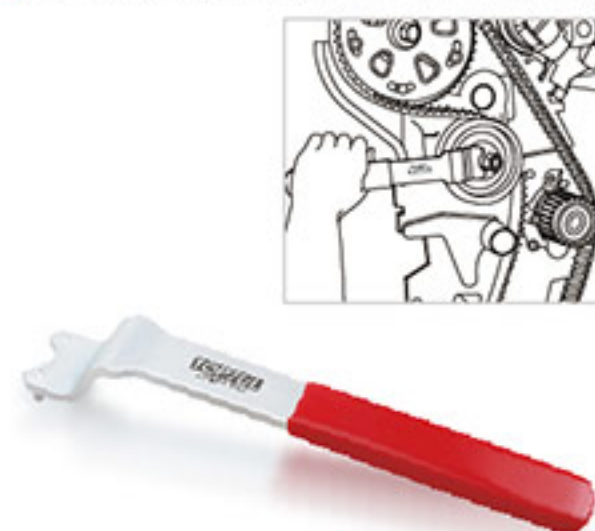

- Steel construction
- 2-pin timing belt tensioner tool
- Pin Diameter: 3mm
- Offset design
- Useful for camshaft spur belt tension adjustment
- Application: VW, Audi and etc.

ITEM NO.	LENGTH (mm)	PIN DIAMETER (mm)	20	80
JDBP1703	172	3	20	80

Audi / VW Belt Pulley Reaction Wrench



- Designed for locking on water-pump pulley
- Easy loosening of stubborn screws on the water-pump pulley
- 1/2" square drive in the handle to allow extension of the tool
- Application: Audi 80/A4, VW Golf, Polo, Passat and etc.

ITEM NO.	L (mm)	INNER DIAMETER Ø (mm)	SCREW DIAMETER Ø (mm)	10	40
JDBX0115	250	32	14	10	40

Audi / VW Belt Pulley Reaction Wrench (deep-drawn type)



- Used for locking deep-drawn water-pump pulley
- Easy loosening of stubborn screws on the water-pump pulley
- Ideal for Audi and Volkswagen vehicle's engine when air conditioning is also built in
- Comfortable plastic grip handle
- Application: Audi, VW and etc.

ITEM NO.	L (mm)	INNER DIAMETER Ø (mm)	SCREW DIAMETER Ø (mm)	10	40
JDBX0241	300	31	14	10	40

Injection Pump Wrench



- Chrome Vanadium Steel material
- 90° angle for leverage
- Professional quality for maximum durability and corrosion resistance
- Single Box-End Wrench for repair toothed belt or adjust the injection starts, injection pump removal and locking screws
- Applications: 1.6L 4-cyl. Diesel engine Audi 80, VW Golf, Jetta, Caddy, Passat, Santana, Citroën

ITEM NO.	SIZE (mm)	L (mm)	10	160
JDBW1316	13	160	10	160

11PCS
Universal Pulley Holder & Fan Clutch Set



ITEM NO. JGAI1101 **10 (SET)**

- Designed for holding crankshaft and injection pump pulley
- Total Length 520mm provides optimal lever for tightening and loosening bolt
- Includes 4 pairs inter-changeable screw bolts (Bolt size: Ø6, Ø8, Ø10, Ø16mm)
- Suitable for most type vehicles

BLOW CASE: W710 x D105 x H55 (mm)

Pulley Removing Wrench



• JDAF1437: V-Belt Pulleys

• JDAG1437: Poly-V Belt Pulleys

- To lock the pulley during removing or assembling any type of pulley retaining bolt
- High flexibility outperforms the traditional standard strap or chain wrench, and will not damage components
- Ideal for water pump, alternator pulleys and various electric motor pulleys of compressors, washing machines, tool machines and etc.
- Also suitable to rotate the cam shaft when timing the engine and to remove oil and gasoline filters

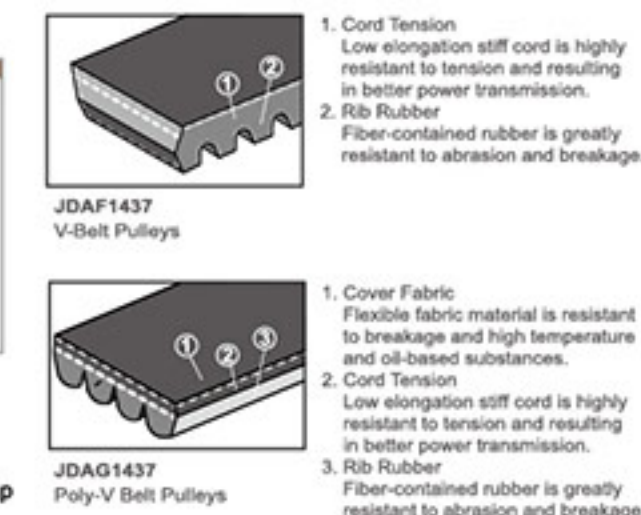

JDAF1437 V-Belt Pulleys

JDAG1437 Poly-V Belt Pulleys

ITEM NO.	CAPACITY Ø (mm)	LENGTH (mm)	12	36
JDAF1437	40 - 140	365 (14 - 3/8")	12	36
JDAG1437	40 - 140	365 (14 - 3/8")	12	36

Spline Alternator Combination Bit Socket (M10)



- The two-part alternator socket allows easy removal and replacement of the free-wheel drive pulley at the alternator
- This tool allows the alternator to be locked by the M10 spline bit socket insert and enables the central locking bolt of the pulley to be loosened or tightened by the serrated reaction nut
- Use with 17mm wrench
- 33 teeth hexagonal reaction nut, O.D. 19.5mm
- Applications: BMW, VW, Audi, Ford, Skoda, Mercedes-Benz, Porsche, Renault and etc.

ITEM NO.	DRIVE	SIZE	Teeth	● (mm)	L (mm)	🔧	📦
JDCD3310	1/2"	M10	33	17	110	10	80

Star Alternator Combination Bit Socket (T50)



- The two-part alternator socket allows easy removal and replacement of the free-wheel drive pulley at the alternator
- This tool allows the alternator to be locked by the T50 star bit socket insert and enables the central locking bolt of the pulley to be loosened or tightened by the serrated reaction nut
- Use with 17mm wrench
- 33 teeth hexagonal reaction nut, O.D. 19.5mm
- Applications: Mercedes-Benz, Renault and etc.

ITEM NO.	DRIVE	SIZE	Teeth	● (mm)	L (mm)	🔧	📦
JDCD3350	1/2"	T50	33	17	110	10	80

V-Belt Pulley Remover



- Made of Chrome Vanadium Alloy Steel
- Special design to stop the pulley and remove the centre bolts for removing and installing the V-belt pulley at the generator
- Use with 17mm wrench and spline bit socket (M10) to remove and install the socket
- Applicable: VW Golf 3, Vento, Passat, Audi A3, Volvo and etc.

ITEM NO.	Teeth	● (mm)	O.D. Ø (mm)	I.D. Ø (mm)	L (mm)	🔧	📦
JDBD3317	33	17	19.5	11.8	30	10	180

22PCS Radial Seal Removal and Installation Kit



- ITEM NO. JGAI2201** 10 (SET)
- Comprehensive tool kits for easy removing and installation camshaft and crankshaft seals on engine without damaging new seals
 - Compact puller with specialized hook for quick removal the cams seals
 - Allows the crank seal to be replaced without dismantling the crank case and avoid scraping the crank surface
 - Suitable for all pressed radial seal
 - Kits services seal sizes from 27mm to 58mm
 - Set includes 1 pc puller, 2 sets of puller hooks (length): 73, 119 mm, 1 pc installer plate, 7 pcs blue seal adapters for mounting of radial sealing rings (outer Ø x inner Ø): 27.6x21.6, 33.6x27.5, 41.9x36.0, 45.9x40.0, 48.9x43.0, 56.0x50.3, 64.0x58.0 mm, 4 pcs large silver space adapters to compensate the differences in length of central screw (length): 10, 18, 22, 27 mm, 7 pcs small silver bolt adapters for normal central bolts (inner Ø): 8, 10, 12, 14, 16, 18, 20 mm

13PCS Alternator Pulley Remover Kit



- Designed for the easy removal of alternator free-wheel drive pulleys either on or off the vehicle
- Locks the alternator, allowing the central locking bolt of the pulley to be released
- Applications: BMW, VW, Audi, Mercedes-Benz, Renault, Ford, Porsche, Fiat and etc.

ITEM NO. JGAI1301 12 (SET)

ITEM NO.	CONTENTS
1	Spline Alternator Combination Bit Socket (W/33 Teeth Hex Reaction Nut) 1/2" Dr. x M10, L=110mm, Hex: 17mm
1	Star Alternator Combination Bit Socket (W/33 Teeth Hex Reaction Nut) 1/2" Dr. x T50, L=110mm, Hex: 17mm
2	10mm Hex Shank Hexagon Bits 8mm & 10mm (L=75mm)
2	10mm Hex Shank Star Bits T40 & T50 (L=75mm)
2	10mm Hex Shank Spline Bits M8 & M10 (L=75mm)
1	Quick Change Bit Holder 1/2" Dr. x 10mm (Hex)
1	33 Teeth Hex Reaction Nut Hex: 17mm, O.D. 19.5mm, I.D. 11.8mm L=30mm
1	33 Teeth Hex Reaction Nut Hex: 22mm, O.D. 19.5mm, I.D. 11.8mm L=30mm
1	Hexagon Reaction Nut Hex: 22mm, I.D. 11.8mm L=32mm
1	4 Pin Round Reaction Nut with Hex Tip Hex: 17mm, O.D. 35mm, I.D. 11.8mm L=37mm

BLOW CASE: W245 x D145 x H45 (mm)

Mechanic's Stethoscope

- A mechanic's stethoscope is a sensitive instrument. It can be fitted with a variety of ends, including needle probes and rubber trumpets, specially designed for automotive use.



- ITEM NO. JDAX0102** 12
- Effectively locating trouble spots within the engine block
 - Listen for trouble by tracing sound of flowing water, oil, gas or steam
 - Use to quickly identify piston slap, worn gears, faulty valves, water pump failure, damaged gaskets and defective bearings
 - Ideal for pinpointing the source of noises in engines, transmissions, differentials and bearings as well as the unusual vibrations or suspected leaks
 - Aluminum Alloy probe extends to 275mm (10-13/16") allows safe access to hard to reach spots
 - Supplied with rubber trumpet for user quick checking vacuum and pressure flow
 - Flexible tubing and shockproof PP material plastic sound conduction

Deep Star Sockets (Cylinder Head Bolt Tool)



- Chrome Vanadium Steel Material
 - Specially designed for removing and installing the cylinder head bolts
 - Spring-ball locking design can hold the bolt tightly during operation
 - Applications: BMW, Mercedes-Benz, Opel, Vauxhall and etc.
- | DRIVE | ITEM NO. | SIZE | L (mm) | 🔧 | 📦 |
|-------|----------|------|--------|---|----|
| 1/2" | BAEJ1612 | E12 | 140 | 8 | 80 |
| | BAEJ1614 | E14 | 140 | 8 | 80 |
- 12.5mm sq.

Ribe Bit Sockets (Cylinder Head Bolt Tool)



- Chrome Vanadium Steel socket, S2 steel Bit
 - Specially designed for use on VW and Audi cylinder head bolts
- | DRIVE | ITEM NO. | SIZE | L (mm) | 🔧 | 📦 |
|-------|-----------|------|--------|----|-----|
| 1/2" | BCYA1610S | M10S | 100 | 10 | 160 |
| | BCYA1610 | M10S | 140 | 10 | 100 |
- 12.5mm sq.
- TOPTUL product item no. BCRA1610 can not replace the use of this particular product.

Battery Pole and Terminal Cleaner

- Wire brushes remove corrosion build-up on battery pole and terminals for improved electrical contact
- The external brush cleans cable clamps, and the internal brush battery poles
- Metal case battery brush



ITEM NO.	LENGTH (mm)	🔧	📦
JDBV3984	84	12	72

Piston Ring Compressor



ITEM NO.	HEIGHT (inch)	CAPACITY (mm)	🔧	📦
JAAA1303	3	53 - 125	30	60
JAAA1804	4	90 - 175	30	60
JAAA1806	6	90 - 175	20	40

Piston Ring Pliers



- Made of high grade special tool steel
- For installing and removing piston rings
- Bright nickel-plated

ITEM NO.	CAPACITY Ø (mm)	L (mm)	🔧	📦
JABA0510	50 - 100	215	12	48
JABA0812	80 - 120	225	12	48
JABA1116	110 - 160	255	12	48

Piston Ring Groove Cleaning Tool



- Quick and reliable removal of carbon deposits from piston ring grooves
- Suitable for piston sizes from Ø51mm to Ø127mm
- Three 6-bladed cutters cover all major piston ring grooves
- Blade #1: 1/16", 5/64", 3/32", 1/8", 5/32", 3/16"
- Blade #2: 2, 2.5, 3, 4, 4.5mm & 1/4"
- Blade #3: 1.2, 1.5, 1.8, 2.8, 5, 5.5mm

ITEM NO.	PISTON DIAMETER (mm)	L (mm)	🔧	📦
JDCV0205	51 - 127 (2" - 5")	290	12	48

56PCS
Professional Threaded Coil-Insert Repair Kit (For Spark Plug Thread)



- Ideal for repairing and restoring damaged spark plug thread
- Completed set for easy and quick repairs of spark plug, thread insert size - M10, M12, M14
- Each size includes Stainless Steel Screw Coils, Thread Tap & Coil Shielding Collar, Coil Installation Shank and Hex Key Wrench

ITEM NO.	CONTENTS	10 (SET)
JGAI5601	<ul style="list-style-type: none"> 45 Stainless Steel Screw Coil Inserts 15PCS - M10 x 1.0mm x 3/8" (L=9.5mm) 15PCS - M12 x 1.25mm x 3/4" (L=19mm) 15PCS - M14 x 1.25mm x 7/16" (L=11mm) 1 Install Main Tool (P-type) 3 Thread Taps M10 x 1.0mm, M12 x 1.25mm, M14 x 1.25mm 3 Coil Shielding Collar M10, M12, M14 3 Coil Installation Shank M10, M12, M14 1 Hex Key Wrench 	

BLOW CASE: W298x D298 x H62 (mm)

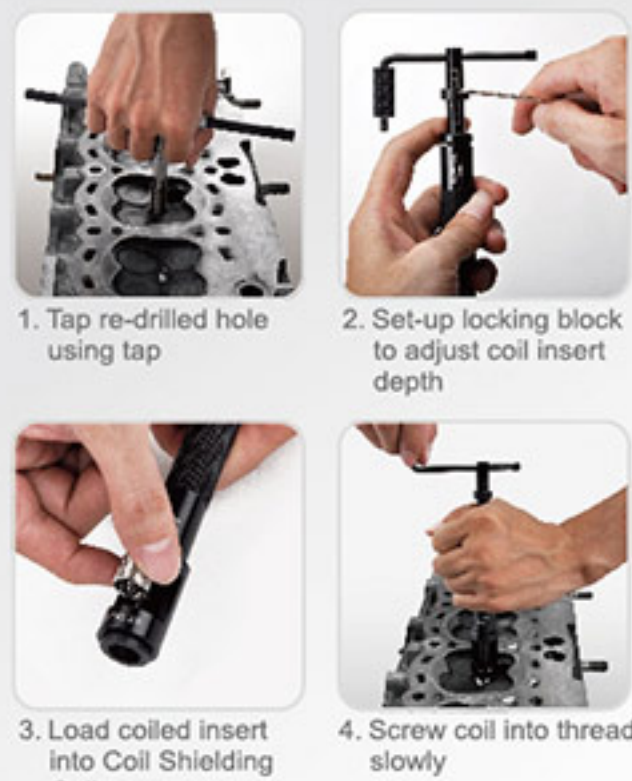

10PCS
Professional Threaded Coil-Insert Repair Kit (For Spark Plug Thread)



- Ideal for repairing and restoring damaged spark plug thread
- For most commonly used metric bolt size M14, suitable for machine construction, engine repair and other automotive applications

ITEM NO.	CONTENTS	30 (SET)
JGAI1003	<ul style="list-style-type: none"> 1 Install Main Tool (P-type) 1 2mm Hex Key Wrench 1 HSS Thread Tap M14 x 1.25mm 1 Coil Shielding Collar M14 1 Coil Installation Shank M14 5 Stainless Steel Screw Coil Inserts M14 x 1.25mm x 7/16" (L=11mm) 	

BLOW CASE: W250 x D128 x H41 (mm)

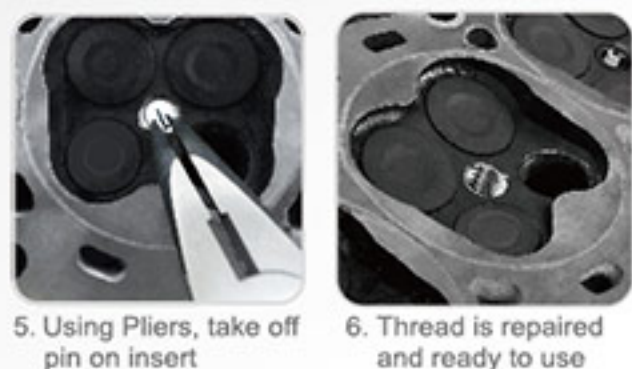

3PCS
3/8" DR. Glow Plug Socket Set



8 / 10 / 12MM



- 6-point socket made of hardened and tempered Chrome Vanadium Steel
- Internal rubber retaining ring for positive retention of plug in socket
- 180° universal joint design allows easy access in confined engine bays
- Suitable for the removal and replacement of glow plugs in most popular diesel engines
- Matt chrome plated finish
- Application: Mercedes-Benz, Audi, VW, Opel, Fiat and etc.

ITEM NO.	CONTENTS	15 (SET)
JGAI0301	<ul style="list-style-type: none"> 3 JDBM1208~JDBM1212 3/8" Dr. Glow Plug Sockets (75mmL) 8, 10, 12 mm 	

BLOW CASE: W120 x D81 x H36 (mm)

3/8" DR. Deep Spark Plug Socket **Spark Plug Gap Gauge (Coin Type)**



- Rubber insert for positive plug protection and retention
- Professional quality, 12-point deep sockets manufactured from hardened and tempered Chrome Vanadium Steel
- Designed for easy installation or removal of the deep-seated (deeply recessed) spark plugs
- Fitted with a rubber insert for plug protection and retention
- Knurled finger grips for hand starting
- Polished chrome plated

DRIVE	ITEM NO.	SIZE (mm)	L (mm)	D (mm)	10 (SET)
3/8"	BSBA1214S	14	90	20	10
	BSBA1214L	14	250	19	10

ITEM NO.	Measuring Range	24	288
JDBU0210	0.020" - 0.100" (0.6 - 2.4mm)		

3/8" DR. Oxygen Sensor Socket (Low Profile Offset)



- Made of Chrome Molybdenum Steel, heat treated, black oxide finish
- Remove & install sensors on computerized engine control vehicles
- 3/8" DR. 7/8" (22mm) 6PT socket with cutaway length 30mm portion for wire clearance
- Offset design for confined areas

ITEM NO.	SIZE (mm)	L (mm)	25	100
JDAR1222	22	30		

1/2" DR. Oxygen Sensor Socket



- Made of Chrome Vanadium Steel, heat treated, black oxide finish
- Remove & install sensors on computerized engine control vehicles
- 1/2" DR. 1-1/16" (27mm) 12PT socket with cutaway portion for wire clearance

ITEM NO.	SIZE (mm)	L (mm)	10	100
JDAQ1627	27	78		

1/2" DR. Heated Oxygen Sensor Socket



- Made of heat treated, durable Chrome Molybdenum Alloy Steel
- Remove & install sensors on computerized engine control vehicles
- 7/8" (22mm) Hex, 1/2" Square Drive (double square for easy access)
- Socket with cutaway portion for wire clearance
- Offset design for confined areas
- Material: CR-MO
- Finish: Black oxide

ITEM NO.	SIZE (inch)	L (mm)	10	100
JDAR0122	7/8	50		

3/8" DR. Oxygen Sensor Vacuum Switch Socket



- Made of heat treated Chrome Vanadium Steel
- Install and removes oxygen sensors and vacuum switches on computerized engine control vehicles
- 22mm (7/8") 6-point socket with cutaway slot provides extra clearance for sensor wires
- Use with 3/8" square drive tools or 1" end wrench on the external hex
- Black phosphate finish for added corrosion resistance

ITEM NO.	SIZE (mm)	L (mm)	12	72
JDAQ0122	22	90		

1/2" DR. Oxygen Sensor Socket



ITEM NO.	SIZE (mm)	L (mm)	20	80
JDAQ1622	22	85		

7PCS
Sensor & Sending Unit Socket Set

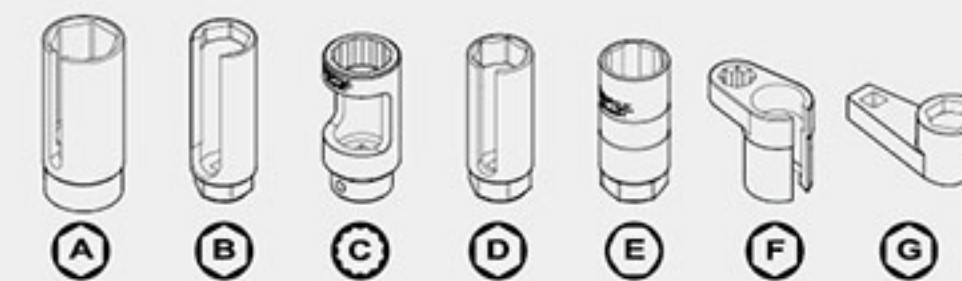

- Set contains 7 assorted sockets for removal and installation of Oxygen Sensor, Oil Pressure Sending Units and Vacuum Switches
- Specially designed tools to use and work on a variety of vehicles
- Sockets are made of heat treated, durable Chrome Vanadium Alloy Steel (A-E) and Chrome Molybdenum Alloy Steel (F&G)

ITEM NO.	CONTENTS	DRIVE	SIZE (inch)	L (mm)	10 (SET)
JGAI0701	<ul style="list-style-type: none"> 1 JDAS0129 Oil Pressure Sending Unit Socket 1 JDAQ0122 Universal Vacuum PVS, TVS Valve and Oxygen Sensor Socket 1 JDAQ1627 GM Thermal Sensor Switch Socket 1 JDAQ0222 Oxygen Sensor Socket 1 JDAS0227 Oil Pressure Sending Unit Socket 1 JDAR0122 Heated Oxygen Sensor Socket 1 JDAR0222 Low Profile Offset Oxygen Sensor Socket 	1/2"	1-3/16 (29mm)	90	
		3/8"	7/8	90	
		1/2"	1-1/16 (27mm)	78	
		3/8"	7/8	80	
		3/8"	1 & 1-1/16	74	
		1/2"	7/8	50	
		3/8"	7/8	30	

BLOW CASE: W232 x D203 x H54 (mm)

Cotter Pin Puller

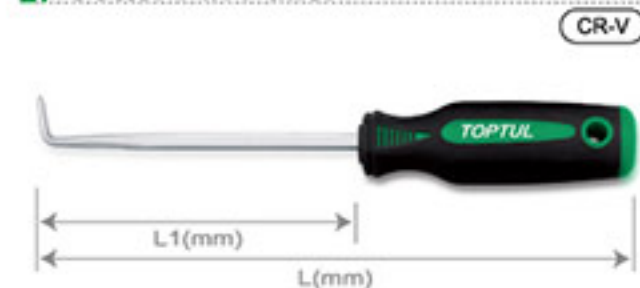

ITEM NO.	L1 (mm)	L (mm)	Weight	Box Qty
JJAK0101	125	235	5	40

Radiator Hose Remover



ITEM NO.	L1 (mm)	L (mm)	Weight	Box Qty
JJAK0201	80	190	5	40

4PCS Miniature Hook & Pick Set



ITEM NO.	CONTENTS	Weight	Box Qty
GAAR0401	JJAK0301 Awl / Straight Mini Pick JJAK0303 Curved Mini Hook JJAK0304 45 Degree Bent Tip Mini Pick JJAK0302 90 Degree Bent Tip Mini Pick	10 (SET)	

Radiator Hose Remover



- Ideal for pulling out hose or removing stickers, o-ring and seals
- Unique hose blade design for easy using in confined space
- Rugged tool with a large comfortable bi-component PP+TPR plastic handle

ITEM NO.	L1 (mm)	L (mm)	Weight	Box Qty
JJAK0425	130	245	5	40

Scraper



ITEM NO.	L1 (mm)	L (mm)	Weight	Box Qty
JJAJ0813	125	245	5	40

Door Upholstery Remover



ITEM NO.	L1 (mm)	L (mm)	Weight	Box Qty
JJAE1011	110	230	5	40

Door Upholstery Remover



- Blade made from special high quality SVCM tool steel
- Rugged tool with a large comfortable bi-component PP+TPR plastic handle
- Removes plastic door panel fasteners without breakage

ITEM NO.	L1 (mm)	L (mm)	Weight	Box Qty
JJAE0612	115	225	5	40

Door Upholstery Remover



- For plastic upholstery fasteners
- Place tool under edge of door panel and insert into fastener as then simply pry up

ITEM NO.	L1 (mm)	L (mm)	Weight	Box Qty
JJAE0812	120	245	10	40

Radiator Hose Remover



- Ideal for pulling out hose or removing stickers, o-ring and seals
- Unique hose blade design for easy using in confined space
- Rugged tool with a large comfortable bi-component PP+TPR plastic handle

ITEM NO.	L1 (mm)	L (mm)	Weight	Box Qty
JJAK0525	130	245	5	40

Stainless Steel Putty Knife (Flexible Scraper)



ITEM NO.	BLADE SIZE (W x L) (mm)	BLADE THICKNESS (mm)	Weight	Box Qty
JDAB3205	32 x 100	0.5	10	60
JDAB5005	50 x 100	0.5	10	60
JDAB7605	76 x 100	0.5	5	30

Stainless Steel Bolstered Scraper



ITEM NO.	BLADE SIZE (W x L) (mm)	BLADE THICKNESS (mm)	Weight	Box Qty
JDAD3218	32 x 100	1.8	10	60
JDAE3218	32 x 100	1.8	10	60
JDAD5018	50 x 100	1.8	10	60

Stainless Steel Pinchweld Scraper



ITEM NO.	BLADE SIZE (W x L) (mm)	BLADE THICKNESS (mm)	Weight	Box Qty
JDAD3225	32 x 100	2.5	10	60
JDAC2012	20 x 50	1.2	10	60
JDAC2025	20 x 50	2.5	10	60
JDAD3212	32 x 100	1.2	10	60

3PCS Stainless Steel Putty Knife Set



ITEM NO.	CONTENTS	Weight	Box Qty
JGAT0301	1 JDAB7605 - 76 x 100 x 0.5 mm 1 JDAB5005 - 50 x 100 x 0.5 mm 1 JDAB3205 - 32 x 100 x 0.5 mm	20 (SET)	

3PCS Stainless Steel Bolstered Scraper Set



ITEM NO.	CONTENTS	Weight	Box Qty
JGAT0302	1 JDAD5018 - 50 x 100 x 1.8 mm Straight Blade 1 JDAE3218 - 32 x 100 x 1.8 mm Bent Blade 1 JDAD3218 - 32 x 100 x 1.8 mm Straight Blade	20 (SET)	

4PCS Stainless Steel Pinchweld Scraper Set



ITEM NO.	CONTENTS	Weight	Box Qty
JGAT0401	1 JDAD3212 - 32 x 100 x 1.2 mm 1 JDAC2012 - 20 x 50 x 1.2 mm 1 JDAC2025 - 20 x 50 x 2.5 mm 1 JDAD3225 - 32 x 100 x 2.5 mm	20 (SET)	



Light Dinging Spoon



ITEM NO.	W (mm)	H (mm)	L (mm)	Weight	Box Qty
JFCA0127	48	58	250	12	72

Drip Moulding Spoon



ITEM NO.	W (mm)	H (mm)	L (mm)	Weight	Box Qty
JFCD0124	49	70	235	6	12

Double Blade Spoon



ITEM NO.	W (mm)	H (mm)	L (mm)	Weight	Box Qty
JFCC0140	58	172	401	4	8
JFCC0251	59	179	510	2	8

Flat Spoon



ITEM NO.	W (mm)	H (mm)	L (mm)	Weight	Box Qty
JFCB0125	30	99	250	12	48
JFCB0229	51	68	286	6	24

// Curved Dolly



ITEM NO.	W (mm)	H (mm)	L (mm)	Weight	Volume
JFBA0108	58	70	80	4	12

// Curved Dolly



ITEM NO.	W (mm)	H (mm)	L (mm)	Weight	Volume
JFBI0113	58	45	133	6	12

// Large End Dolly



ITEM NO.	W (mm)	H (mm)	L (mm)	Weight	Volume
JFBE0113	70	125	90	4	16

// Heel Dolly



ITEM NO.	W (mm)	H (mm)	L (mm)	Weight	Volume
JFBJ0108	61	30	79	6	24

// Angle Dolly



ITEM NO.	W (mm)	H (mm)	L (mm)	Weight	Volume
JFBF0111	59	16	108	6	24

// Round Peen End Dolly



ITEM NO.	W (mm)	H (mm)	L (mm)	Weight	Volume
JFBC0113	44	Ø54	125	6	24

// Double End Round Dolly



ITEM NO.	W (mm)	L (mm)	Weight	Volume
JFBD0106	Ø56	58	6	12

// Toe Dolly



ITEM NO.	W (mm)	H (mm)	L (mm)	Weight	Volume
JFBG0112	58	29	121	6	12

// Anvil Dolly



ITEM NO.	W (mm)	H (mm)	L (mm)	Weight	Volume
JFBE0215	67	146	139	2	12

// Utility Dolly



ITEM NO.	W (mm)	H (mm)	L (mm)	Weight	Volume
JFBH0107	70	64	70	6	12

// Thin Toe Dolly



ITEM NO.	W (mm)	H (mm)	L (mm)	Weight	Volume
JFBG0212	55	24	118	6	24

// Dome Dolly



ITEM NO.	W (mm)	H (mm)	L (mm)	Weight	Volume
JFBE0315	61	30	155	2	16

// Double End Hand Dolly



ITEM NO.	W (mm)	H (mm)	L (mm)	Weight	Volume
JFBD0208	62	75	66	6	12

// Grid Dolly



ITEM NO.	W (mm)	H (mm)	L (mm)	Weight	Volume
JFBG0312	58	30	120	6	12

// Anvil Dolly



ITEM NO.	W (mm)	H (mm)	L (mm)	Weight	Volume
JFBB0110	72	62	102	4	16

// Shrinking Dolly



ITEM NO.	W (mm)	H (mm)	L (mm)	Weight	Volume
JFBG0412	58	29	120	6	12



HAMMER

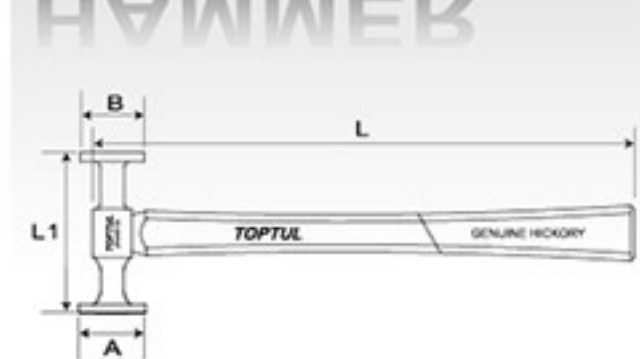

// Light Bumping Hammer - Flat Face



ITEM NO.	A (mm)	B (mm)	L1 (mm)	L (mm)	Weight	Volume
JFAA0333	Ø32	25 x 25	91	325	6	36

// Pick & Finishing Hammer - Crowned Face



ITEM NO.	A (mm)	L1 (mm)	L (mm)	Weight	Volume
JFAC0333	Ø40	138	325	6	36

// Heavy Shrinking Hammer - Flat Face + Shrink Milled Square Face

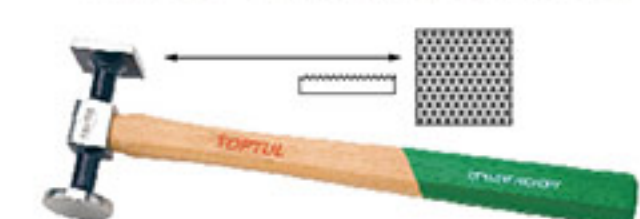

ITEM NO.	A (mm)	B (mm)	L1 (mm)	L (mm)	Weight	Volume
JFAB0133	Ø40	38 x 38	100	325	6	36

// Light Bumping Hammer - Crowned Face



ITEM NO.	A (mm)	B (mm)	L1 (mm)	L (mm)	Weight	Volume
JFAA0433	Ø32	25 x 25	91	325	6	36

// Curved Pein & Finishing Hammer - Crowned Face



ITEM NO.	A (mm)	L1 (mm)	L (mm)	Weight	Volume
JFAC0233	Ø40	140	325	6	36

// Light Shrinking Hammer - Flat Face + Milled Square Face

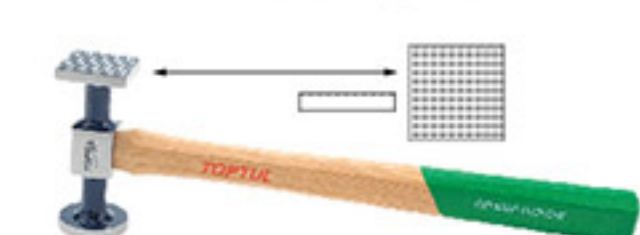

ITEM NO.	A (mm)	B (mm)	L1 (mm)	L (mm)	Weight	Volume
JFAB0233	Ø40	38 x 38	100	325	6	36

// Reverse Curve Hammer - Crowned Face



ITEM NO.	A (mm)	B (mm)	L1 (mm)	L (mm)	Weight	Volume
JFAA0533	Ø29.5	25.5 x 25.5	104	325	6	36

// Straight Pein & Finishing Hammer - Crowned Face



ITEM NO.	A (mm)	L1 (mm)	L (mm)	Weight	Volume
JFAC0133	Ø40	141	325	6	36

// Standard Bumping Hammer - Flat Face



ITEM NO.	A (mm)	B (mm)	L1 (mm)	L (mm)	Weight	Volume
JFAA0133	Ø40	38 x 38	100	325	6	36

// Standard Bumping Hammer - Crowned Face



ITEM NO.	A (mm)	B (mm)	L1 (mm)	L (mm)	Weight	Volume
JFAA0233	Ø40	38 x 38	98.5	325	6	36

// 7PCS Professional Grade Auto Body Repair Tool Set

AUTO BODY REPAIR



- Professional quality meets industrial standards
- Drop forged tool steel dollies, heat treated, includes Utility Dolly, Curved Dolly, Heel Dolly and Toe Dolly
- Drop forged tool steel hammers, selected hickory, includes Pick & Finishing Hammer, Light Shrinking Hammer and Standard Bumping Hammer
- Easy latch case holds all tools securely in place and provides excellent tool protection

ITEM NO.	CONTENTS	Weight	Volume
GAAI0702	1 JFAB0233 - Light Shrinking Hammer (Flat Face + Milled Square Face) 1 JFAA0133 - Standard Bumping Hammer (Flat Face) 1 JFAC0333 - Pick & Finishing Hammer (Crowned Face) 1 JFBI0113 - Curved Dolly 1 JFBG0112 - Toe Dolly 1 JFBJ0108 - Heel Dolly 1 JFBH0107 - Utility Dolly	3 (SET)	

BLOW CASE: W478 x D234 x H100 (mm)

Heavy Duty Clamp



- Single-way pull operation
- Bolt Size: Ø19mm x 140mm(L)
- Gripping Surface: 46mm (wide) / 21mm (deep)
- Material: Drop Forged Chrome Molybdenum Alloy Steel

ITEM NO.	Pulling Capacity (tons)	CR	MO
JFDA0105	5	1	6

Big Mouth Clamp



- Single-way pull operation
- Bolt Size: Ø14mm x 120mm(L)
- Gripping Surface: 37mm (wide) / 15mm (deep)
- Material: Drop Forged Chrome Molybdenum Alloy Steel

ITEM NO.	Pulling Capacity (tons)	CR	MO
JFDB0103	3	1	6

Frame Rack Clamp (Two-Way)



- Two-way pull operation
- The special puller design used with plate increases tool durability
- Bolt Size: Ø17mm x 72mm(L)
- Gripping Surface: 118mm (wide) / 18mm (deep)
- Material: Drop Forged Chrome Molybdenum Alloy Steel

ITEM NO.	Pulling Capacity straight way (tons)	Pulling Capacity cross way (tons)	CR	MO
JFDE0205	5	3	1	6

Box Clamp



- Single-way pull operation
- Two sides of the jaws are different in order to fit the confined space
- Bolt Size: Ø14mm x 120mm(L)
- Gripping Surface: 37mm (wide) / 15mm (deep)
- Material: Drop Forged Chrome Molybdenum Alloy Steel

ITEM NO.	Pulling Capacity (tons)	CR	MO
JFDB0303	3	1	6

Box Clamp (Two-Way)



- Two-way pull operation
- Bolt Size: Ø14mm x 120mm(L)
- Gripping Surface: 37mm (wide) / 15mm (deep)
- Material: Drop Forged Chrome Molybdenum Alloy Steel

ITEM NO.	Pulling Capacity straight way (tons)	Pulling Capacity cross way (tons)	CR	MO
JFDB0203	3	2	1	6

Frame Rack Clamp



- Single-way pull operation
- The special puller design used with plate increases tool durability
- Bolt Size: Ø17mm x 72mm(L)
- Gripping Surface: 118mm (wide) / 18mm (deep)
- Material: Drop Forged Chrome Molybdenum Alloy Steel

ITEM NO.	Pulling Capacity (tons)	CR	MO
JFDE0105	5	1	6

Small Mouth Pull Clamp



- Single-way pull operation
- Perfect to use in the confined space
- Bolt Size: Ø17mm x 80mm(L)
- Gripping Surface: 44mm (wide) / 24mm (deep)
- Material: Drop Forged Chrome Molybdenum Alloy Steel

ITEM NO.	Pulling Capacity (tons)	CR	MO
JFDC0105	5	1	6

Mini Clamp (Two-Way)



- Two-way pull operation
- Bolt Size: Ø12mm x 44mm(L)
- Gripping Surface: 37mm (wide) / 12mm (deep)
- Material: Drop Forged Chrome Molybdenum Alloy Steel

ITEM NO.	Pulling Capacity straight way (tons)	Pulling Capacity cross way (tons)	CR	MO
JFDF0203	3	2	1	10

Double Hook Clamp (Double Claw Hook)



- Body repair chain joint with double claw hooks
- For use as a chain shortener or chain connector
- Use with 5/16", 3/8" chains
- Material: Drop Forged Chrome Molybdenum Alloy Steel

ITEM NO.	Pulling Capacity (tons)	CR	MO
JFEA0106	6	1	10

Thin Edge Mouth Clamp



- Single-way pull operation
- Perfect to use in hard to reach places
- Spring-loaded for easy opening
- Bolt Size: Ø12mm x 65mm(L)
- Gripping Surface: 33mm (wide) / 27mm (deep)
- Material: Drop Forged Chrome Molybdenum Alloy Steel

ITEM NO.	Pulling Capacity (tons)	CR	MO
JFDD0105	5	1	12

Small Mouth Pull Clamp (Two-Way)



- Two-way pull operation
- Perfect to use in the confined space
- Bolt Size: Ø17mm x 80mm(L)
- Gripping Surface: 44mm (wide) / 24mm (deep)
- Material: Drop Forged Chrome Molybdenum Alloy Steel

ITEM NO.	Pulling Capacity straight way (tons)	Pulling Capacity cross way (tons)	CR	MO
JFDC0205	5	2	1	6



Slide Hammer Dent Puller Set



ITEM NO. JGA1202 2 (SET)

- Features: Commonly used tool set to use on body panel and vehicle chassis. Designed to work on body repair, chassis, bumper ends, fender edge, door, door edge...etc. or other unique pulling applications. Heavy duty slide hammer action with 10 lbs hammer and various attachments; Slide Shaft, Slide Hammer, Washer, Slide Shaft Handle, Flat Pipe, Large Hook Type Plate, Small Hook Type Plate, 90 Angle Thick Hook Plate, 90 Angle Thin Hook Plate, Two Hole Pipe, Flat Plate, Chain & Hook, Screw Puller to suit different pulling jobs.

BLOW CASE: W600 x D210 x H100 (mm)

KIT CONTENT



Part No.	Description	Q'ty
1	Slide Shaft	1
2	Slide Hammer	1
3	Flat Pipe	1
4	Large Hook Type Plate	1
5	Small Hook Type Plate	1
6	90 Angle Thick Hook Plate	1
7	90 Angle Thin Hook Plate	1
8	Two Hole Pipe	1
9	Flat Plate	1
10	Chain & Hook	1
11	Screw Puller	1
12	Washer	1
13	Slide Shaft Handle	1

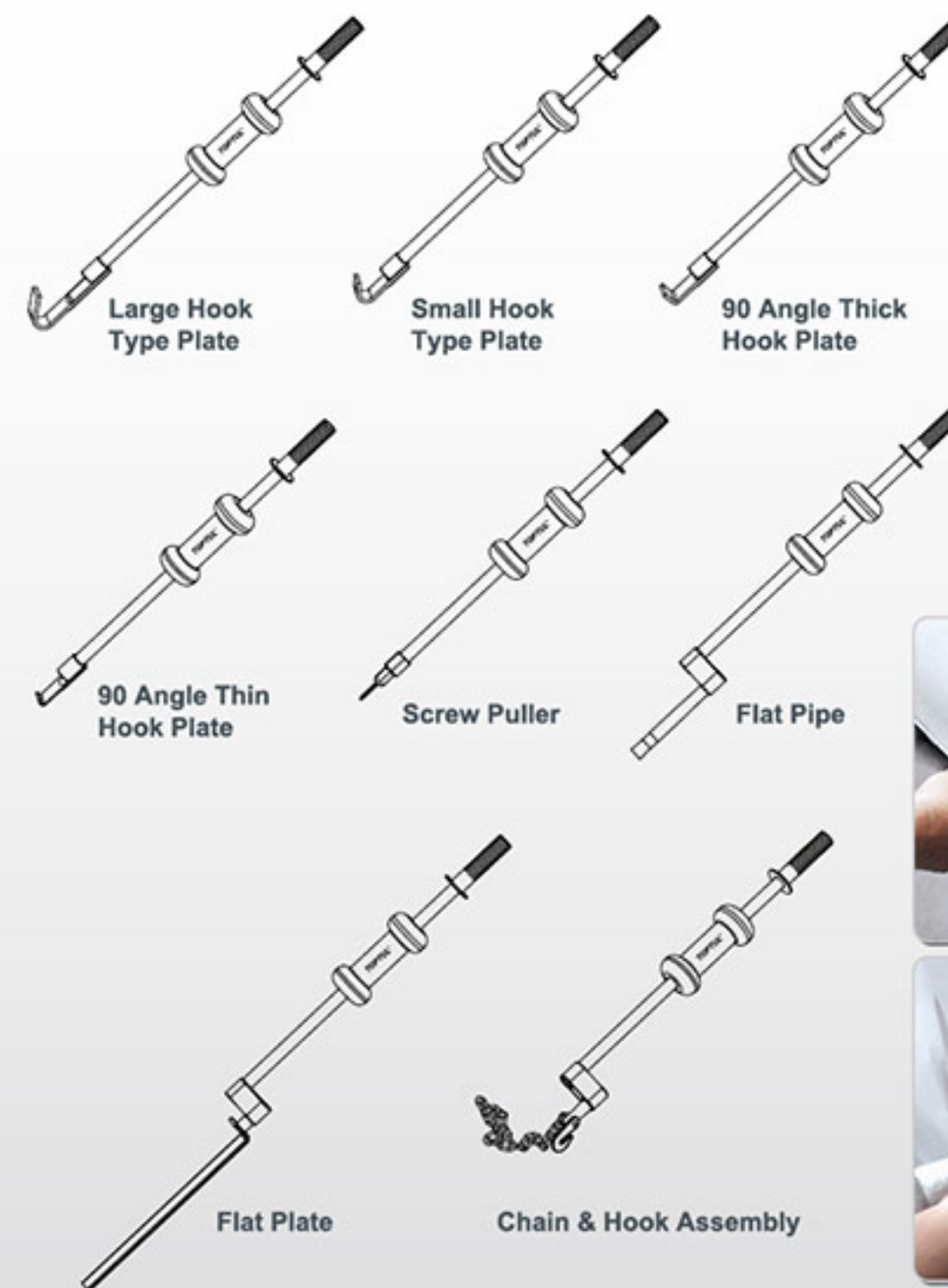

Self-Locking Multi-Grip Pliers with Wide Flat Jaws



- Chrome Molybdenum Alloy Steel Jaw
- Clamps lap joints allowing four consecutive spot welds without tool removal
- Suitable for spot welding and auto-body repair works
- Easy one-handed push button release

ITEM NO.	JAW ADJUSTMENT (mm)	L (mm)	W (mm)	H (mm)
DMA11A08	0 - 12	200	12	24

Self-Locking Multi-Grip Pliers with Wide Curved Jaws



- Chrome Molybdenum Alloy Steel Jaw
- Clamps two butt or adjacent joints
- Enables to work in tight spots
- Easy one-handed push button release

ITEM NO.	JAW ADJUSTMENT (mm)	L (mm)	W (mm)	H (mm)
DMAK1A09	0 - 10	215	12	36

Self-Locking Multi-Grip Pliers with Straight Jaws



- Chrome Molybdenum Alloy Steel Jaw
- Allows to work in narrow areas
- Easy one-handed push button release

ITEM NO.	JAW ADJUSTMENT (mm)	L (mm)	W (mm)	H (mm)
DMAM1A08	0 - 18	195	6	36

Self-Locking Multi-Grip Pliers with Double Curved Jaws



- Chrome Molybdenum Alloy Steel Jaw
- Clamps two flanged lapped or adjacent joints
- Suitable for auto-body repair works
- Easy one-handed push button release

ITEM NO.	JAW ADJUSTMENT (mm)	L (mm)	W (mm)	H (mm)
DMAJ1A09	0 - 10	230	12	24

Self-Locking Multi-Grip Pliers with Angled Jaws



- Chrome Molybdenum Alloy Steel Jaw
- Clamps two flanged lap joints
- Enables to work in tight spots
- Easy one-handed push button release

ITEM NO.	JAW ADJUSTMENT (mm)	L (mm)	W (mm)	H (mm)
DMAL1A09	0 - 15	210	6	36

Plugweld Locking Pliers



- Solid copper pad on fixed jaw prevents burn-through when plug welding thin sheet-metal panels
- Weld does not stick to copper which also allows for quick cooling
- U-shape bottom jaw provides even pressure around welding spot
- Quick-release level easily unlocks the pliers

ITEM NO.	JAW ADJUSTMENT (mm)	L (mm)	W (mm)	H (mm)
DMAH1A10	0 - 50	250	5	50

Trim Clip Removal Pliers



- For quick removing staples, clips, door panels, fascia and trim supports without damage
- Wide nose design to prevent breaking or tearing panels when undoing facings
- Designed for accessing difficult to reach places
- Made of Chrome Molybdenum Steel, black pliers head, comfort grip handle
- Total length: 240mm (9-1/2")

ITEM NO.	LENGTH (mm)	W (mm)	H (mm)
JJAN0109	240 (9-1/2")	12	36

Trim Removal Wedge



- Made from high impact resistant nylon material to minimize scratches
- Smooth tapered design simplifies insertion
- Hang-up design for convenient storage
- Place tool under edge of panel or trim to remove trims and internal fittings

ITEM NO.	SIZE(L) x (W) x (H) mm	W (mm)	H (mm)
JJAP1219	190 x 30 x 23	8	128

Windshield Wiper Arm Puller

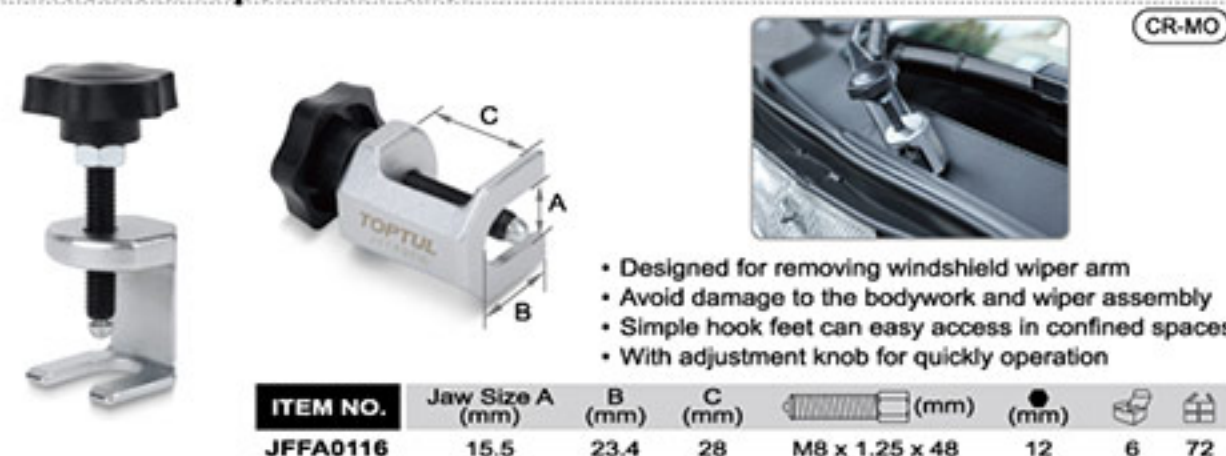

- Designed for removing windshield wiper arm
- Avoid damage to the bodywork and wiper assembly
- Simple hook feet can easy access in confined spaces
- With adjustment knob for quickly operation

ITEM NO.	Jaw Size A (mm)	B (mm)	C (mm)	W (mm)	H (mm)	W (mm)	H (mm)
JFFA0116	15.5	23.4	28	M8 x 1.25 x 48	12	6	72

Windshield Wiper Arm Remover

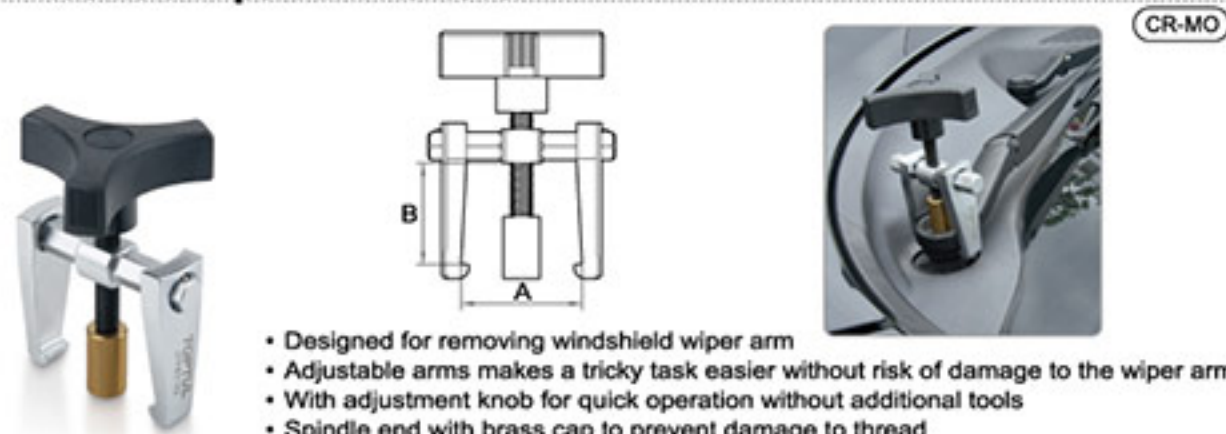

- Designed for removing windshield wiper arm
- Adjustable arms makes a tricky task easier without risk of damage to the wiper arm
- With adjustment knob for quick operation without additional tools
- Spindle end with brass cap to prevent damage to thread

ITEM NO.	min. / max. (mm)	B (mm)	W (mm)	H (mm)
JFFB0142	15 - 42	37	M8 x 1.25 x 43	6 72

6PCS Mini Handy Remover Set



- Made from high impact resistant nylon material to minimize scratches
- Specific slim profile design and unique shape for easy removal
- Place tool under edge of panel or trim to remove trims and internal fittings

ITEM NO.	CONTENTS	12 (SET)
JGAS0601	1 JJAP0620 Angled Clip Panel Remover - 30 x 200mm 1 JJAP0720 Flat Clip Panel Remover - 30 x 200mm 1 JJAP0820 Panel Remover - 24 x 200mm 1 JJAP0920 Sharp Panel Remover - 24 x 200mm 1 JJAP1020 Straight Panel Remover - 17 x 200mm 1 JJAP1120 Clip Panel Remover - 37 x 200mm	

5PCS Handy Remover Set



- For plastic upholstery fasteners
- Place tool under edge of door panel and insert into fastener as fast as possible, and then simply pry up
- Large support area to protect clips and pad

ITEM NO.	CONTENTS	12 (SET)
JGAS0501	1 JJAP0118 Remover Pull Type - 30 x 180mm 1 JJAP0220 Handy Remover - 30 x 200mm 1 JJAP0318 Remover Narrow Type - 20 x 180mm 1 JJAP0421 Upholstery Clip Remover - 20 x 210mm 1 JJAP0516 Remover Wide Type - 60 x 160mm	

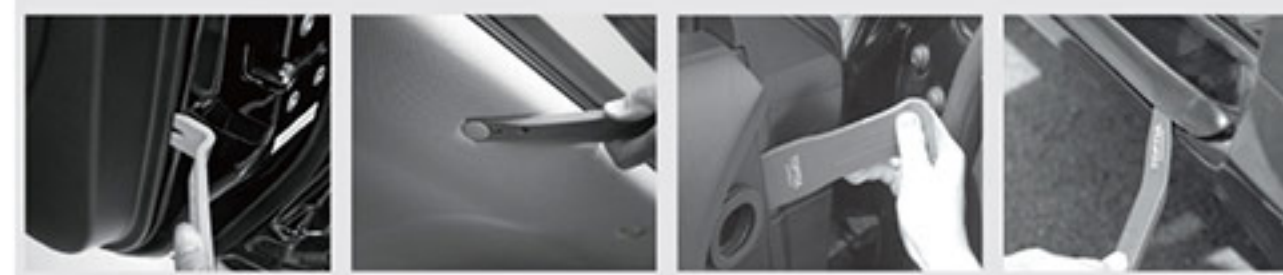

Single Vacuum Suction Cup Lifter



- Sturdy plastic handle with rubber suction cup
- Suitable for flat and non-porous surface materials, e.g., glass, tiles, sheet metal, marble

ITEM NO.	CUP DIAMETER (mm)	LIFTING CAPACITY (kg)	W (mm)	H (mm)
JJBD1112	120	40	6	48

Double Vacuum Suction Cup Lifter with Flexible Head



- Sturdy plastic handle with two rubber suction cups
- Adjustable handle design for curved surface
- Ideal for transporting and positioning of windshields during fitting

ITEM NO.	CUP DIAMETER (mm)	LIFTING CAPACITY (kg)	W (mm)	H (mm)
JJBD2212	120	65	4	8

4PCS Windshield Removal Tool Set



- A specific tool set for easy and safe removal of any style of windshield including acutely angled ones
- Tool set includes a 72 feet triangle stainless cutting wire that can be cut to any desired length, 2 wire gripping handle and a wire feeder tool that can be piercing through the glue trim
- Made of expert quality tool steel with reinforced composite plastic handle

ITEM NO.	CONTENTS	8	32
JGAR0403	1 JLBH0125 Wire Feeder Tool 2 JLBH0208 Wire Gripping Handle 1 JLBH0307 72 Feet Triangle Stainless Cutting Wire		

Manual Fluid Extractor



15 Liter



Inlet Adapter & 1 meter Silicone Brake Bleeder Hose

Inlet Adapter & Ø10mm x 1 meter Nylon Extension Tube

Ø6.7mm x 1 meter Nylon Suction Tube

Ø4.8mm x 1 meter Nylon Suction Tube

- Using hand vacuum pump to quickly, cleanly and easily extract the fluids
- Features an internal float valve designed for automatically cut off when unit has reached maximum storage capacity
- Extract oil through the dipstick hole, no need to use a car lift for oil change
- Suitable for extracting all types of engine oil, transmission oil, brake fluid, coolant, water and etc.
- Includes 1 meter in length of Ø4.8mm, Ø6.7mm, Ø10mm nylon suction/extension tubes and a silicone brake bleeder hose

ITEM NO.	Capacity (L)	Fluid Temperature Range	Weight	Volume
JJBZ0115	15	1°C - 100°C (34°F - 212°F)	1	2

Brake Bleeder Valve with Reception Bottle

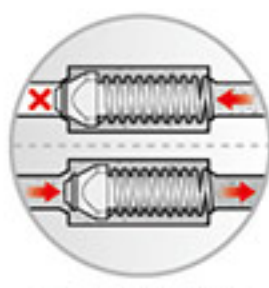

• Non-Return Valve

- Easy to replace the brake fluid by one person
- Non-return valve prevents old brake fluid or exhausted air backflow
- Transparent hose to evaluate the condition of the fluid and presence of air
- Suitable for cars, trucks, motorcycles and etc.
- Including detachable hook

ITEM NO.	Capacity (ml)	Hose Length (m)	Weight	Volume
JECF0180	800	1	1	30

Pneumatic Brake Bleeder (European Type)



2 Liter



- Suitable for most standard and ABS brake systems
- The manual trigger has a locking mechanism (fixing ring lock) to provide hands-free operation and keep extracting oil continuously
- Automatically cut off design (shut-off valve) to prevent overflow
- Equips with a noise-reduction silencer for a quieter working environment
- The unit contains a vacuum fluid extractor and a silicone bleeding hose with brake nipple

ITEM NO.	JEDF01B0E	Weight	Volume
		12 (SET)	
SPECIFICATIONS			
Working Pressure	40 - 170 PSI (2.8 - 12 BAR)		
Average Air Consumption	2 CFM		
Air Inlet	1/4" PT		
Fluid Temperature Range	-19°C - 60°C (-3°F - 140°F)		
Container Capacity	2 Liter (2000 ml)		
Silicone Hose	1M		

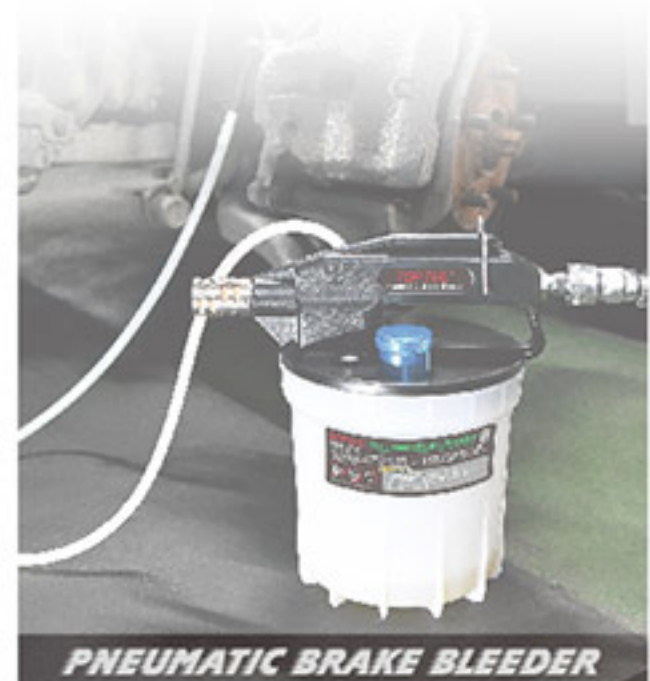

PNEUMATIC BRAKE BLEEDER

Tube Cutter, Flaring & Swaging Tool Set



- 45° Flares and swages soft steel tubing such as soft copper, Aluminum and brass tubing
- Swages in close quarters where punch style cannot be used
- Flaring bar with size capacity: 1/8", 3/16", 1/4", 5/16", 3/8", 7/16", 1/2", 5/8", 3/4" O.D. tubing
- Tube cutter capacity: 1/8" to 1-1/8"
- Swage adapters: 3/16", 1/4", 5/16", 3/8", 1/2", 5/8", 3/4"

ITEM NO.	CONTENTS	Weight	Volume
JGAI1001	<ul style="list-style-type: none"> • Flaring Bar (Small Size) 1/8", 3/16", 1/4", 5/16", 3/8", 7/16" O.D. Tubing • Flaring Bar (Large Size) 1/2", 5/8", 3/4" O.D. Tubing • Tube Cutter W/Retractable Reamer Cutting capacity: 1/8" to 1-1/8" • Steel Yoke • Swaging Adapter 3 in 1 (3/16", 1/4", 3/8"), 5/16", 1/2", 5/8", 3/4" • 45° Flaring Adapter 	10 (SET)	
BLOW CASE: W265 x D215 x H62 (mm)			

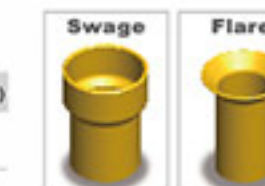

Tube Cutter & Double Flaring Tool Set



- Specially designed tool kit to double flare tubing for high pressure application in automotive, air conditioning and etc.
- Accurately single or double flares soft steel tubing such as cooper, Aluminum and brass tubing for leak free connections
- Screw-type 45° flaring press
- Tube cutter capacity: 1/8" to 1-1/8"
- Flaring bar & adapter sizes: 3/16", 1/4", 5/16", 3/8", 7/16", 1/2" & 5/8"

ITEM NO.	CONTENTS	Weight	Volume
JGAI1002	<ul style="list-style-type: none"> • Flaring Bar 3/16", 1/4", 5/16", 3/8", 7/16", 1/2", 5/8" O.D. Tubing • Tube Cutter W/Retractable Reamer Cutting capacity: 1/8" to 1-1/8" • Steel Yoke W/45° Flaring Cone • Flaring Adapter 3/16", 1/4", 5/16", 3/8", 7/16", 1/2", 5/8" O.D. Tubing 	10 (SET)	
BLOW CASE: W265 x D215 x H62 (mm)			

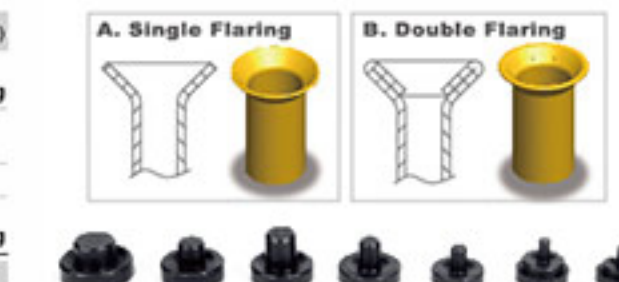

7PCS Air Blow and Suction Gun



Change from vacuum to blower simply by reversing the internal valve

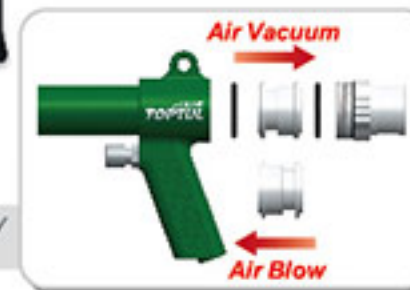

ITEM NO.	GDAE0702	Weight	Volume
		10 (SET)	
<ul style="list-style-type: none"> • Air Inlet: 1/4" PT • Working Pressure: 90 PSI • Simply change the installation direction of the inner valve to convert between air blower to vacuum • Ideal cleaning accessory for garages and workshops • Suitable for cleaning car seat, engine room, cabinet, wood chips, metal shavings, powders and etc. • Contents: Aluminum gun, flexible hose, dust bag, extension tube, small tube, flat tube and brush 			

8PCS Air Blow and Suction Gun (One-Hand Switchable Type)



One-hand reversing vacuum / blower switch

ITEM NO.	GDAE0801	Weight	Volume
		10 (SET)	
<ul style="list-style-type: none"> • Air Inlet: 1/4" PT • Working Pressure: 90 PSI • One-touch regulator knob quickly converts between air blower to vacuum • Ideal cleaning accessory for garages and workshops • Suitable for cleaning car seat, engine room, cabinet, wood chips, metal shavings, powders and etc. • Content: Aluminum gun, flexible tube, dust bag, extension tube, small tube, flat tube, flexible hose and brush 			

375

13PCS

Motorcycle Chain Breaker and Riveting Tool Set



#25 - #530



ITEM NO. JGA11304

24 (SET)

- Comprehensive kits for breaking and riveting most types of chain quickly and easily
- Expert quality and designed for most sizes of drive or cam chain from #25 to #530
- To press the rivet from #520 or up easily, it is recommended to grind rivet heads off first
- The sets are included 3 breaking pin sizes to fit most chains (2.2mm, 2.9mm, 3.8mm diameter)

BLOW CASE: W220 x D120 x H50 (mm)

Spark Plug Terminal Pliers



- Specially designed tool to remove cable terminals from spark plugs quickly and safely
- Curved designed jaws grip the cable terminals tightly without damages
- Heavy-duty plastic coating for pliers' jaws and handles provides a shockproof sure grip

ITEM NO.	LENGTH (mm)	6	72
JIAA0108	200 (8")		

394PCS

Rubber O-Ring Assortment Kit



- Universal O-Ring assortment, perfect for professional workshops and garages
- O-ring made of Nitrile Rubber (NBR 70) material
- Kit contains the most commonly used metric sizes o-rings for industrial and automotive applications
- 32 different sizes in metric measurements

ITEM NO. CONTENTS 20 (SET)

JGEW394A Metric O-Ring Sizes: (I.D. x Thickness)
 3 x 1 (36pcs), 4 x 1 (17pcs), 5 x 2 (9pcs),
 6 x 2 (17pcs), 8 x 2 (17pcs), 10 x 2 (17pcs),
 11 x 2 (17pcs), 12 x 2 (17pcs), 14 x 2 (17pcs),
 17 x 2 (17pcs), 20 x 2 (17pcs), 10 x 3 (11pcs),
 12 x 3 (11pcs), 16 x 3 (11pcs), 18 x 3 (11pcs),
 22 x 3 (11pcs), 20 x 4 (9pcs), 22 x 4 (9pcs),
 24 x 4 (9pcs), 25 x 4 (9pcs), 30 x 4 (9pcs),
 34 x 4 (9pcs), 36 x 4 (9pcs), 40 x 4 (9pcs),
 45 x 4 (9pcs), 47 x 4 (9pcs), 50 x 4 (9pcs),
 16 x 5 (7pcs), 25 x 5 (14pcs), 30 x 5 (7pcs),
 32 x 5 (7pcs), 35 x 5 (7pcs)

PLASTIC BOX: W275 x D160 x H45 (mm)

20PCS

Radio Removal Tool Set



ITEM NO. JGAA2001 50 (SET)

- Expert quality, selection of keys for the removal and installation of car radios by garages, emergency services and specialist car audio installers
- Suitable for a wide range of applications including VW, BMW, Mercedes-Benz, Audi, Opel, Porsche, Renault, Fiat, Peugeot, Ford, Skoda, Alpine, JVC, Grundig, Blaupunkt, Becker, Clarion, Pioneer & VDO

23PCS

Universal Terminal Release Tool Set



ITEM NO. JGA12301 10 (SET)

- Special designed to release terminals from the plastic connectors without damaging to wires or terminal blocks
- Release terminals on most body wiring connectors
- Assortment of 23 parts for universal application in the auto wire terminal
- Application : BMW, Mercedes-Benz, Opel, VW, Audi, Porsche, Ford, Seat, Skoda, Jaguar, Citroën, Fiat, Saab, Mazda, Renault, Chrysler, Toyota, Honda, Mitsubishi and most vehicles

BLOW CASE: W435 x D250 x H75 (mm)

23PCS
Universal Terminal Release Tool Set

Jack Stands (in pairs)

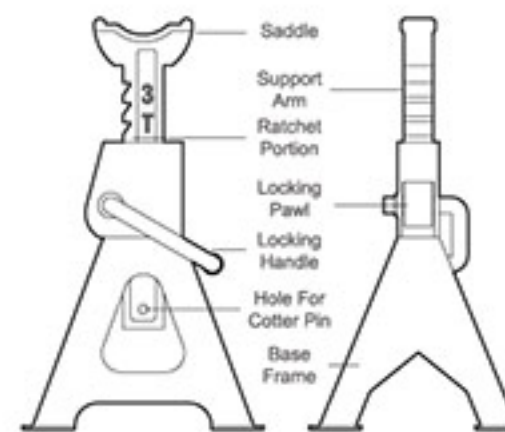

- High quality, steel frame and cast support arm
- Extra large feet to prevent sinking into soft ground or asphalt
- Quick action with 10 stages of height adjustment
- Dual purpose handle serves as carrying handle and column release
- Angled teeth in support arm could prevent accidental release of load while conducting the safety application - The more weight applied, the tighter post is locked

ITEM NO.	CAPACITY (ton)	Min. Height (mm)	Max. Height (mm)	BASE SIZE (mm)	1 (SET)	4 (SET)
JHAA0203	3	285	428	185 x 205		

Plastic Creeper



- Rigid molded, one piece plastic construction
- Shaped arm areas for optimal movement freedom
- Padded head support
- Two built-in tool trays (right & left)
- Six 3" PU swivel caster wheels for easy maneuverability
- Practical hand carry handle
- Maximum load: 135 kg

ITEM NO.	SIZE (L) x (W) x (H) mm	1
JCM-0300	1020 x 480 x 115	

Pro-Series Mechanics Creeper



Full Bearing Caster

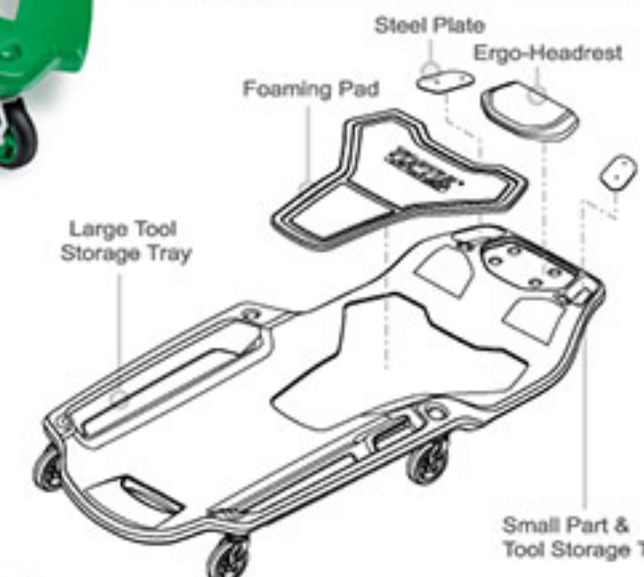

- Rigid molded, one piece plastic construction
- Shaped arm areas for optimal movement freedom
- Padded foaming pad support
- Storage trays on both sides provides quick access to tools and small parts
- Steel plates next to headrest for easy mounting of magnetic lights when needed
- Six 3" TPU swivel caster wheels for easy maneuverability
- Practical built-in hand carry handle
- Maximum Load: 150 kgs

ITEM NO.	SIZE (L) x (W) x (H) mm	1
JCM-0401	1040 x 517 x 135	

Contents	Q'ty	Contents	Q'ty
Main Body	1	Screws	8
Ergo-headrest	1	Steel Plate (Right)	1
Foaming Pad	1	Steel Plate (Left)	1
3" TPU Wheels	6		

Mechanic's Roller Seat



- Durable powder coated steel frame
- PVC foam cushioned seat with wipe clean surface
- One drawer and bottom storage area provides easy and quick access to miscellaneous tools and parts
- Perfect height for wheel, brake or body works and all kind of low repair jobs
- 4 long-wearing 2" high impact poly swivel casters
- Maximum seat height: 340mm
- Seat area: 335 x 225mm
- Maximum loading capacity up to 200 kg
- Supplied one spray can holder

ITEM NO.	SIZE (L) x (W) x (H) mm	1
JCA-350B	350 x 260 x 340	

Magnetic Car Fender Cover W/Pockets



- Perfect for engine repair jobs to avoid paintwork damages
- 8 pieces high powered magnets for sure grip
- 4 tool holding pockets with a maximum loading weight up to 1.5 kg

ITEM NO.	SIZE (W) x (L) mm	1	12
JJAQ1106	1070 x 600 (42" x 23-1/2")		

// Foldable Mechanic's Mat / Kneeling Pad

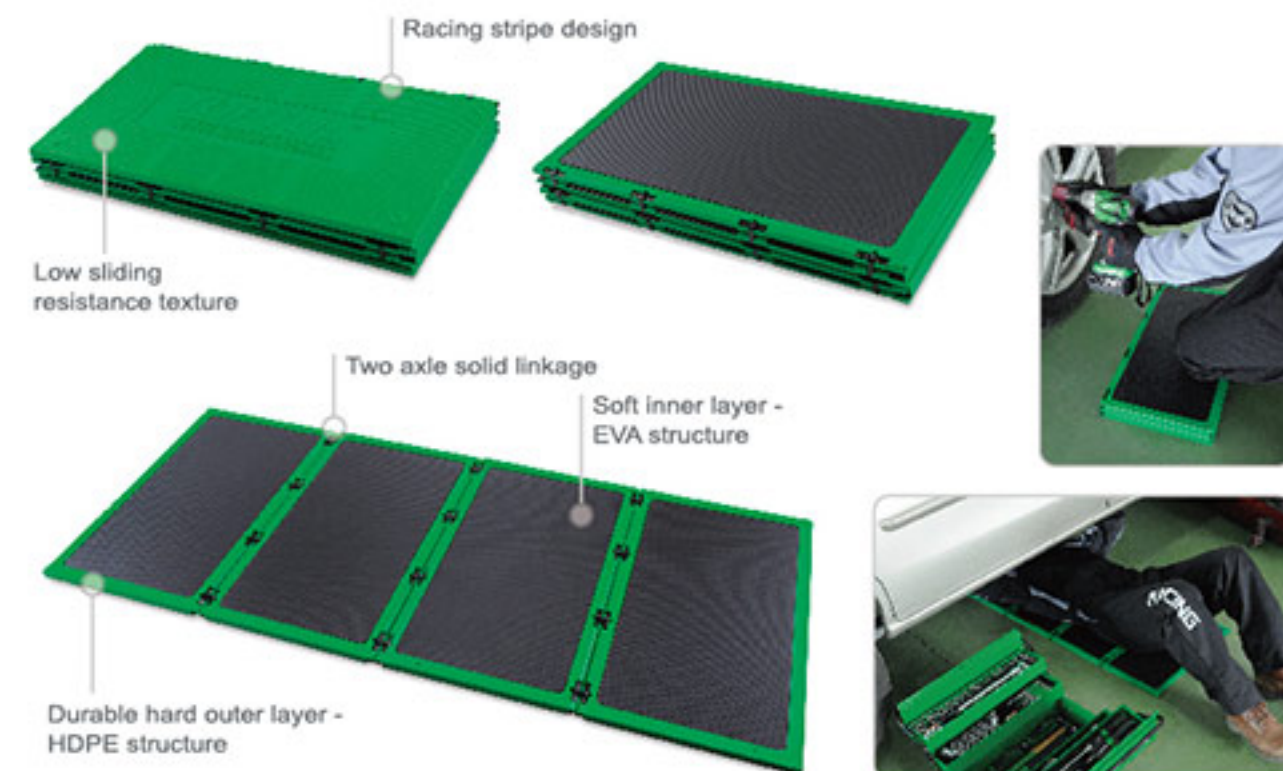

- EVA soft material padded construction for protecting knees while lay on it during service work
- Dirt, water, liquid, oil, gasoline resistant mat
- Quick and easy to clean surface
- Can be folded and easy for carry
- Universal use in workshops, service and breakdown service vehicles

ITEM NO.	SIZE (L) x (W) x (H) mm	SIZE (L) x (W) x (H) mm	1	5
JJ-M480B	480 x 265 x 48	1060 x 480 x 12	1	5

// Mechanic's Mat / Kneeling Pad



- Made of 3 layered padded construction EVA form soft material
- Dirt, water, liquid, oil, gasoline resistant mat
- Quick and easy to clean surface
- Universal use in workshops, service and breakdown service vehicles

ITEM NO.	SIZE (L) x (W) x (H) mm	1	12
JJ-M485	485 x 225 x 30	1	12
JJ-M960	960 x 380 x 30	1	10

// Oil Drain Pan



- Made of high density HDPE plastic, excellent resistance to impact and high temperature
- Heavy duty construction design with reinforced pan bottom
- Integral spout help pour waste oils and fluids cleanly and accurately into disposal containers
- Self-contained overflow edge (anti-splash lip) contains fluid and prevents spillage when pouring
- Three large and easy grip comfortable handles for safe carrying and outpouring
- Ideal for collecting antifreeze, oil and different fluids
- Also suitable for parts cleaning operations
- Meets PAHs regulations

ITEM NO.	CAPACITY (Liter)	SIZE (L) x (W) x (H) mm	20
JDCE0108	8	500 x 400 x 130	20
JDCE0112	12	580 x 470 x 130	15
JDCE0118	18	680 x 570 x 130	15



// Seat Protection Cover



Fully Washable

Universal Size

- Ideal for use when vehicles are being serviced, protecting front seats from dirt, grease and oil
- Universal size suitable for most car and van seats
- Reusable and machine washable

ITEM NO.	SIZE (cm)	10
JCS-0102	72 x 134 x 61	10

PROFESSIONAL HAND TOOLS



VDE INSULATED & GENERAL ELECTRICIAN'S TOOLS

Protective insulated & electrician's tools are suited for specific applications when working with electrical systems.