

# Special 2019

## WORLDWIDE



Das Werkzeug

AUTOMOTIVE + INDUSTRIAL

2019



SMWT19/EN/XX/0





Das Werkzeug

Assistent®

# ONE TOOL TROLLEY, 137 EXPERT TOOLS, 2 FREE INCENTIVES!



179N-7 Plastic worktop

or

179NX-7 Stainless steel worktop

CHOOSE YOUR  
 WORKTOP  
 YOURSELF!



Free!

9012 M-1  
 1200 Nm!

5122-3CT  
 40 – 200 Nm!

Made in Germany

12<sup>5</sup>/<sub>16</sub> 163-138/77 1/4" s 4 – 14 mm 1/2" s 10 – 32 mm

1000 Nm  
 12<sup>5</sup>/<sub>16</sub> HiPer  
 916 HP

H x W x D:  
 1020 x 786 x 518 mm

Extremely robust –  
 Made in Germany

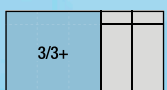

Assistent  
 2K-Safety-Insert-System



## Tool trolley with assortment!

Version with plastic worktop

179N-7/137  
 EAN-No. 4000896215270



or

Version with stainless steel worktop

179NX-7/137  
 EAN-No. 4000896224463



163-374/27 s6 – 24 mm, s6 x7 – 30 x 32 mm

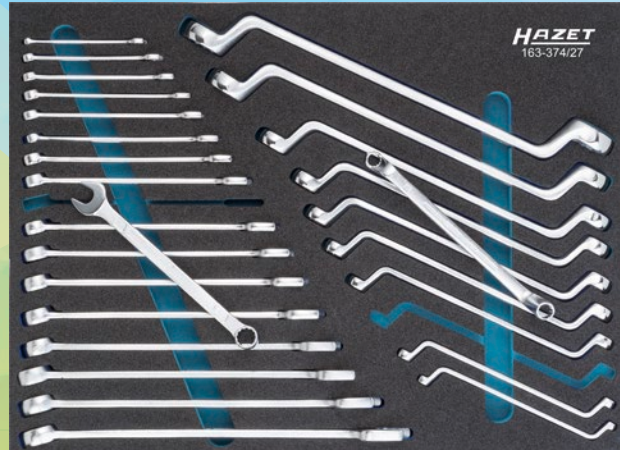

163-141/31







# Tool trolley 179N with assortment



Das Werkzeug

Assistant®

179N-7/220

EAN-No. 4000896220267

220

Tool trolley with 220 expert tools!

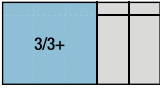

Assistant  
2K-Safety-Insert-System

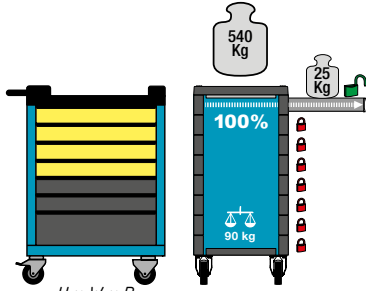

H x W x D:  
1020 x 786 x 518 mm



179 N-7

Made in Germany

Top seller!

163-138/77 1/8" s 4 – 14 mm 1/2" s 10 – 32 mm



163-140/33 1/4" s 10 – 32 mm

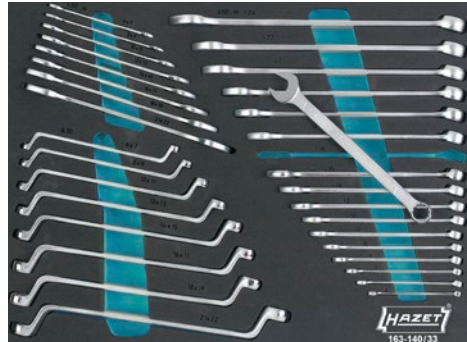

163-143/18



163-141/31



2240N/36



2128 N-1

Assortment contents:



Tool trolley with assortment



## Title image – A work of art!

The illustration on the title page was created by the Brazilian artist and comic book author **Nik Neves**, who currently lives in Berlin. Inspired by much of his time spent travelling, he has developed a unique style that can often be found in or on illustrated maps, book covers, comics or calendars. His work has appeared in "Illustration now! 5" and "Mind the Map" published by "Taschen GmbH, Cologne" and "Die Gestalten Verlag GmbH & Co.KG, Berlin", amongst other publications.



nikneves

PDF download

SWW 2019

www.hazet.de



TecAlliance  
Data Supplier





Das Werkzeug

# Tool trolley 179N XL with assortment



*Assistant*® 179 N XL-7/265  
 EAN-No. 4000896215201

265

Tool trolley with  
 265 expert tools!

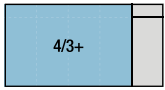

*Assistant*  
 2K-Safety-Insert-System

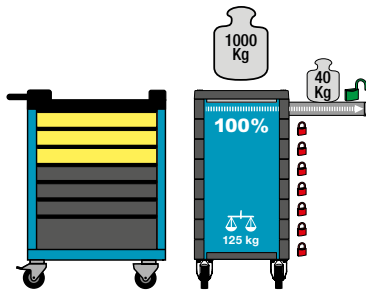

H x W x D:  
 1020 x 959 x 518 mm



GERMAN  
 DESIGN  
 AWARD  
 WINNER  
 2019

179 NXL-6



179 N XL-7

Made in Germany

163-480/57



163-508/138

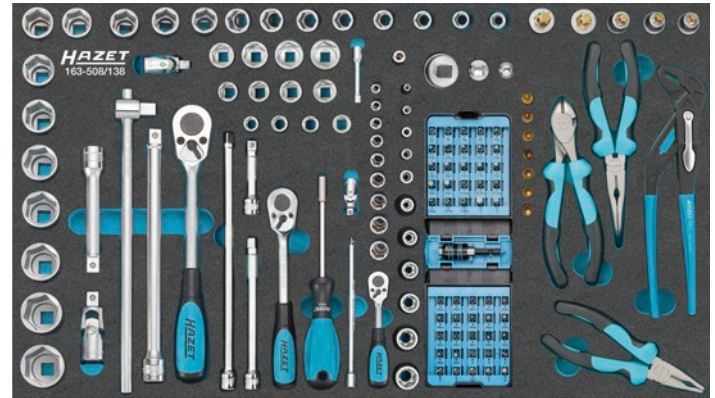

163-507/45

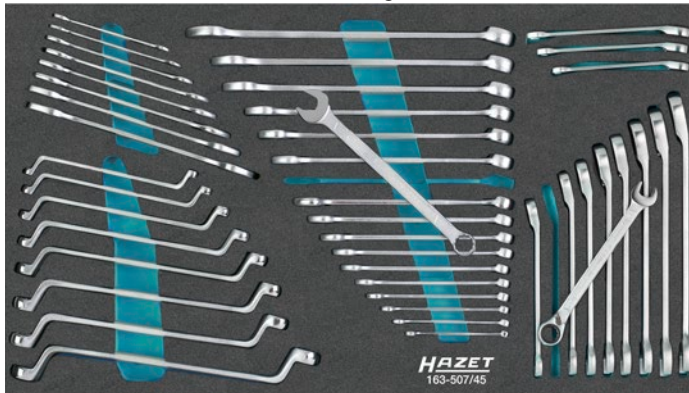

2128 N-1

## Tool trolleys without assortment

HAZET No.	Worktop	Number of drawers	Drawer internal dimensions	EAN-No. 4000896 +
179 N XL-6	Stainless steel	6	W 696 x D 398	215171
179 N XL-7	Stainless steel	7	W 696 x D 398	215164
179 N XL-8	Stainless steel	8	W 696 x D 398	215218

Assortment contents:



Tool trolley with assortment

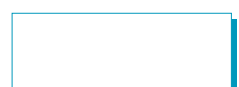







Das Werkzeug

# Tool trolley 179N | 179NX



*Assistant*® 179N  
179NX

**Tool trolley without assortment!**

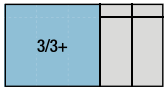

**One tool trolley – two worktops to choose from!**

179N Plastic worktop

or

179NX Stainless steel worktop

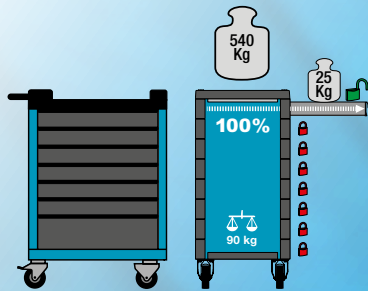

h x w x d:  
1020 x 786 x 518 mm



**Extremely robust –**  
**Made in Germany**



**Made in Germany**

**179N-6**  
 EAN-No. 4000896214570



YouTube clip



**Made in Germany**

**179NX-6**  
 EAN-No. 4000896215560



HAZET No.	Worktop	Number of drawers	Drawer internal dimensions	EAN-No. 4000896 +
179N-6	Plastic	6	W 522 x D 398	214570
179N-7	Plastic	7	W 522 x D 398	214488
179N-8	Plastic	8	W 522 x D 398	214587
179N X-6	Stainless steel	6	W 522 x D 398	215560
179N X-7	Stainless steel	7	W 522 x D 398	215577
179N X-8	Stainless steel	8	W 522 x D 398	215584







# Work bench 179 NW with assortment

Assistant®

179NW-7/230

230

EAN-No. 4000896219605

Work bench with  
230 expert tools!

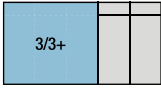

Assistant  
2K-Safety-Insert-System

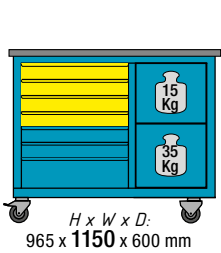

H x W x D:  
965 x 1150 x 600 mm

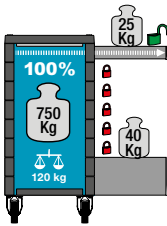

Assortment  
contents:



Work bench  
with assortment



179 NW-7

Made in Germany

163-513/122 63 ¼ 10 9/16 12 1/2 13 1/4 13 3/8 13 1/2



163-526/41



163-525/40

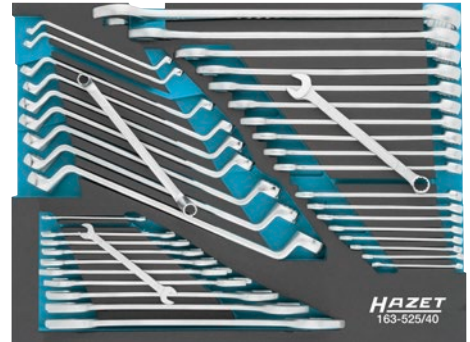

163-372/25



1

Includes fixed mounted door. Only one lock for door and drawers.

2

Flexible vice assembly (front, right, left) e.g. HAZET 2175 N according to drilling template specification

3

Cable duct on rear panel allows battery devices to be charged when the door is closed, for instance

4

Rear view of cable duct

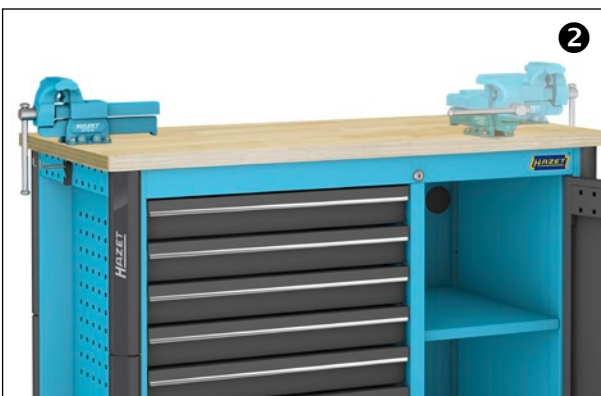



Das Werkzeug

# Tool trolley 178 N with assortment



*Assistant*<sup>®</sup>

**178 N-7/147**

EAN-No. 4000896205080

147

**Tool trolley with 147 expert tools!**

3/3		
-----	--	--

*Assistant*  
2K-Safety-Insert-System

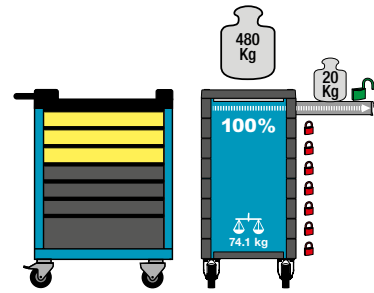

h x w x d:  
1035 x 780 x 496 mm

Tool trolley with assortment



178 N-7  
 Made in Germany

YouTube clip



Assortment contents:



163-466/106 6.3 1/4 1/2 3/4 1 1.25 1.5 1.75 2 2.25 2.5 2.75 3 3.25 3.5 3.75 4 4.25 4.5 4.75 5 5.25 5.5 5.75 6 6.25 6.5 6.75 7 7.25 7.5 7.75 8 8.25 8.5 8.75 9 9.25 9.5 9.75 10 10.25 10.5 10.75 11 11.25 11.5 11.75 12 12.25 12.5 12.75 13 13.25 13.5 13.75 14 14.25 14.5 14.75 15 15.25 15.5 15.75 16 16.25 16.5 16.75 17 17.25 17.5 17.75 18 18.25 18.5 18.75 19 19.25 19.5 19.75 20 20.25 20.5 20.75 21 21.25 21.5 21.75 22 22.25 22.5 22.75 23 23.25 23.5 23.75 24 24.25 24.5 24.75 25 25.25 25.5 25.75 26 26.25 26.5 26.75 27 27.25 27.5 27.75 28 28.25 28.5 28.75 29 29.25 29.5 29.75 30 30.25 30.5 30.75 31 31.25 31.5 31.75 32 32.25 32.5 32.75 33 33.25 33.5 33.75 34 34.25 34.5 34.75 35 35.25 35.5 35.75 36 36.25 36.5 36.75 37 37.25 37.5 37.75 38 38.25 38.5 38.75 39 39.25 39.5 39.75 40 40.25 40.5 40.75 41 41.25 41.5 41.75 42 42.25 42.5 42.75 43 43.25 43.5 43.75 44 44.25 44.5 44.75 45 45.25 45.5 45.75 46 46.25 46.5 46.75 47 47.25 47.5 47.75 48 48.25 48.5 48.75 49 49.25 49.5 49.75 50 50.25 50.5 50.75 51 51.25 51.5 51.75 52 52.25 52.5 52.75 53 53.25 53.5 53.75 54 54.25 54.5 54.75 55 55.25 55.5 55.75 56 56.25 56.5 56.75 57 57.25 57.5 57.75 58 58.25 58.5 58.75 59 59.25 59.5 59.75 60 60.25 60.5 60.75 61 61.25 61.5 61.75 62 62.25 62.5 62.75 63 63.25 63.5 63.75 64 64.25 64.5 64.75 65 65.25 65.5 65.75 66 66.25 66.5 66.75 67 67.25 67.5 67.75 68 68.25 68.5 68.75 69 69.25 69.5 69.75 70 70.25 70.5 70.75 71 71.25 71.5 71.75 72 72.25 72.5 72.75 73 73.25 73.5 73.75 74 74.25 74.5 74.75 75 75.25 75.5 75.75 76 76.25 76.5 76.75 77 77.25 77.5 77.75 78 78.25 78.5 78.75 79 79.25 79.5 79.75 80 80.25 80.5 80.75 81 81.25 81.5 81.75 82 82.25 82.5 82.75 83 83.25 83.5 83.75 84 84.25 84.5 84.75 85 85.25 85.5 85.75 86 86.25 86.5 86.75 87 87.25 87.5 87.75 88 88.25 88.5 88.75 89 89.25 89.5 89.75 90 90.25 90.5 90.75 91 91.25 91.5 91.75 92 92.25 92.5 92.75 93 93.25 93.5 93.75 94 94.25 94.5 94.75 95 95.25 95.5 95.75 96 96.25 96.5 96.75 97 97.25 97.5 97.75 98 98.25 98.5 98.75 99 99.25 99.5 99.75 100 100.25 100.5 100.75 101 101.25 101.5 101.75 102 102.25 102.5 102.75 103 103.25 103.5 103.75 104 104.25 104.5 104.75 105 105.25 105.5 105.75 106 106.25 106.5 106.75 107 107.25 107.5 107.75 108 108.25 108.5 108.75 109 109.25 109.5 109.75 110 110.25 110.5 110.75 111 111.25 111.5 111.75 112 112.25 112.5 112.75 113 113.25 113.5 113.75 114 114.25 114.5 114.75 115 115.25 115.5 115.75 116 116.25 116.5 116.75 117 117.25 117.5 117.75 118 118.25 118.5 118.75 119 119.25 119.5 119.75 120 120.25 120.5 120.75 121 121.25 121.5 121.75 122 122.25 122.5 122.75 123 123.25 123.5 123.75 124 124.25 124.5 124.75 125 125.25 125.5 125.75 126 126.25 126.5 126.75 127 127.25 127.5 127.75 128 128.25 128.5 128.75 129 129.25 129.5 129.75 130 130.25 130.5 130.75 131 131.25 131.5 131.75 132 132.25 132.5 132.75 133 133.25 133.5 133.75 134 134.25 134.5 134.75 135 135.25 135.5 135.75 136 136.25 136.5 136.75 137 137.25 137.5 137.75 138 138.25 138.5 138.75 139 139.25 139.5 139.75 140 140.25 140.5 140.75 141 141.25 141.5 141.75 142 142.25 142.5 142.75 143 143.25 143.5 143.75 144 144.25 144.5 144.75 145 145.25 145.5 145.75 146 146.25 146.5 146.75 147 147.25 147.5 147.75 148 148.25 148.5 148.75 149 149.25 149.5 149.75 150 150.25 150.5 150.75 151 151.25 151.5 151.75 152 152.25 152.5 152.75 153 153.25 153.5 153.75 154 154.25 154.5 154.75 155 155.25 155.5 155.75 156 156.25 156.5 156.75 157 157.25 157.5 157.75 158 158.25 158.5 158.75 159 159.25 159.5 159.75 160 160.25 160.5 160.75 161 161.25 161.5 161.75 162 162.25 162.5 162.75 163 163.25 163.5 163.75 164 164.25 164.5 164.75 165 165.25 165.5 165.75 166 166.25 166.5 166.75 167 167.25 167.5 167.75 168 168.25 168.5 168.75 169 169.25 169.5 169.75 170 170.25 170.5 170.75 171 171.25 171.5 171.75 172 172.25 172.5 172.75 173 173.25 173.5 173.75 174 174.25 174.5 174.75 175 175.25 175.5 175.75 176 176.25 176.5 176.75 177 177.25 177.5 177.75 178 178.25 178.5 178.75 179 179.25 179.5 179.75 180 180.25 180.5 180.75 181 181.25 181.5 181.75 182 182.25 182.5 182.75 183 183.25 183.5 183.75 184 184.25 184.5 184.75 185 185.25 185.5 185.75 186 186.25 186.5 186.75 187 187.25 187.5 187.75 188 188.25 188.5 188.75 189 189.25 189.5 189.75 190 190.25 190.5 190.75 191 191.25 191.5 191.75 192 192.25 192.5 192.75 193 193.25 193.5 193.75 194 194.25 194.5 194.75 195 195.25 195.5 195.75 196 196.25 196.5 196.75 197 197.25 197.5 197.75 198 198.25 198.5 198.75 199 199.25 199.5 199.75 200 200.25 200.5 200.75 201 201.25 201.5 201.75 202 202.25 202.5 202.75 203 203.25 203.5 203.75 204 204.25 204.5 204.75 205 205.25 205.5 205.75 206 206.25 206.5 206.75 207 207.25 207.5 207.75 208 208.25 208.5 208.75 209 209.25 209.5 209.75 210 210.25 210.5 210.75 211 211.25 211.5 211.75 212 212.25 212.5 212.75 213 213.25 213.5 213.75 214 214.25 214.5 214.75 215 215.25 215.5 215.75 216 216.25 216.5 216.75 217 217.25 217.5 217.75 218 218.25 218.5 218.75 219 219.25 219.5 219.75 220 220.25 220.5 220.75 221 221.25 221.5 221.75 222 222.25 222.5 222.75 223 223.25 223.5 223.75 224 224.25 224.5 224.75 225 225.25 225.5 225.75 226 226.25 226.5 226.75 227 227.25 227.5 227.75 228 228.25 228.5 228.75 229 229.25 229.5 229.75 230 230.25 230.5 230.75 231 231.25 231.5 231.75 232 232.25 232.5 232.75 233 233.25 233.5 233.75 234 234.25 234.5 234.75 235 235.25 235.5 235.75 236 236.25 236.5 236.75 237 237.25 237.5 237.75 238 238.25 238.5 238.75 239 239.25 239.5 239.75 240 240.25 240.5 240.75 241 241.25 241.5 241.75 242 242.25 242.5 242.75 243 243.25 243.5 243.75 244 244.25 244.5 244.75 245 245.25 245.5 245.75 246 246.25 246.5 246.75 247 247.25 247.5 247.75 248 248.25 248.5 248.75 249 249.25 249.5 249.75 250 250.25 250.5 250.75 251 251.25 251.5 251.75 252 252.25 252.5 252.75 253 253.25 253.5 253.75 254 254.25 254.5 254.75 255 255.25 255.5 255.75 256 256.25 256.5 256.75 257 257.25 257.5 257.75 258 258.25 258.5 258.75 259 259.25 259.5 259.75 260 260.25 260.5 260.75 261 261.25 261.5 261.75 262 262.25 262.5 262.75 263 263.25 263.5 263.75 264 264.25 264.5 264.75 265 265.25 265.5 265.75 266 266.25 266.5 266.75 267 267.25 267.5 267.75 268 268.25 268.5 268.75 269 269.25 269.5 269.75 270 270.25 270.5 270.75 271 271.25 271.5 271.75 272 272.25 272.5 272.75 273 273.25 273.5 273.75 274 274.25 274.5 274.75 275 275.25 275.5 275.75 276 276.25 276.5 276.75 277 277.25 277.5 277.75 278 278.25 278.5 278.75 279 279.25 279.5 279.75 280 280.25 280.5 280.75 281 281.25 281.5 281.75 282 282.25 282.5 282.75 283 283.25 283.5 283.75 284 284.25 284.5 284.75 285 285.25 285.5 285.75 286 286.25 286.5 286.75 287 287.25 287.5 287.75 288 288.25 288.5 288.75 289 289.25 289.5 289.75 290 290.25 290.5 290.75 291 291.25 291.5 291.75 292 292.25 292.5 292.75 293 293.25 293.5 293.75 294 294.25 294.5 294.75 295 295.25 295.5 295.75 296 296.25 296.5 296.75 297 297.25 297.5 297.75 298 298.25 298.5 298.75 299 299.25 299.5 299.75 300 300.25 300.5 300.75 301 301.25 301.5 301.75 302 302.25 302.5 302.75 303 303.25 303.5 303.75 304 304.25 304.5 304.75 305 305.25 305.5 305.75 306 306.25 306.5 306.75 307 307.25 307.5 307.75 308 308.25 308.5 308.75 309 309.25 309.5 309.75 310 310.25 310.5 310.75 311 311.25 311.5 311.75 312 312.25 312.5 312.75 313 313.25 313.5 313.75 314 314.25 314.5 314.75 315 315.25 315.5 315.75 316 316.25 316.5 316.75 317 317.25 317.5 317.75 318 318.25 318.5 318.75 319 319.25 319.5 319.75 320 320.25 320.5 320.75 321 321.25 321.5 321.75 322 322.25 322.5 322.75 323 323.25 323.5 323.75 324 324.25 324.5 324.75 325 325.25 325.5 325.75 326 326.25 326.5 326.75 327 327.25 327.5 327.75 328 328.25 328.5 328.75 329 329.25 329.5 329.75 330 330.25 330.5 330.75 331 331.25 331.5 331.75 332 332.25 332.5 332.75 333 333.25 333.5 333.75 334 334.25 334.5 334.75 335 335.25 335.5 335.75 336 336.25 336.5 336.75 337 337.25 337.5 337.75 338 338.25 338.5 338.75 339 339.25 339.5 339.75 340 340.25 340.5 340.75 341 341.25 341.5 341.75 342 342.25 342.5 342.75 343 343.25 343.5 343.75 344 344.25 344.5 344.75 345 345.25 345.5 345.75 346 346.25 346.5 346.75 347 347.25 347.5 347.75 348 348.25 348.5 348.75 349 349.25 349.5 349.75 350 350.25 350.5 350.75 351 351.25 351.5 351.75 352 352.25 352.5 352.75 353 353.25 353.5 353.75 354 354.25 354.5 354.75 355 355.25 355.5 355.75 356 356.25 356.5 356.75 357 357.25 357.5 357.75 358 358.25 358.5 358.75 359 359.25 359.5 359.75 360 360.25 360.5 360.75 361 361.25 361.5 361.75 362 362.25 362.5 362.75 363 363.25 363.5 363.75 364 364.25 364.5 364.75 365 365.25 365.5 365.75 366 366.25 366.5 366.75 367 367.25 367.5 367.75 368 368.25 368.5 368.75 369 369.25 369.5 369.75 370 370.25 370.5 370.75 371 371.25 371.5 371.75 372 372.25 372.5 372.75 373 373.25 373.5 373.75 374 374.25 374.5 374.75 375 375.25 375.5 375.75 376 376.25 376.5 376.75 377 377.25 377.5 377.75 378 378.25 378.5 378.75 379 379.25 379.5 379.75 380 380.25 380.5 380.75 381 381.25 381.5 381.75 382 382.25 382.5 382.75 383 383.25 383.5 383.75 384 384.25 384.5 384.75 385 385.25 385.5 385.75 386 386.25 386.5 386.75 387 387.25 387.5 387.75 388 388.25 388.5 388.75 389 389.25 389.5 389.75 390 390.25 390.5 390.75 391 391.25 391.5 391.75 392 392.25 392.5 392.75 393 393.25 393.5 393.75 394 394.25 394.5 394.75 395 395.25 395.5 395.75 396 396.25 396.5 396.75 397 397.25 397.5 397.75 398 398.25 398.5 398.75 399 399.25 399.5 399.75 400 400.25 400.5 400.75 401 401.25 401.5 401.75 402 402.25 402.5 402.75 403 403.25 403.5 403.75 404 404.25 404.5 404.75 405 405.25 405.5 405.75 406 406.25 406.5 406.75 407 407.25 407.5 407.75 408 408.25 408.5 408.75 409 409.25 409.5 409.75 410 410.25 410.5 410.75 411 411.25 411.5 411.75 412 412.25 412.5 412.75 413 413.25 413.5 413.75 414 414.25 414.5 414.75 415 415.25 415.5 415.75 416 416.25 416.5 416.75 417 417.25 417.5 417.75 418 418.25 418.5 418.75 419 419.25 419.5 419.75 420 420.25 420.5 420.75 421 421.25 421.5 421.75 422 422.25 422.5 422.75 423 423.25 423.5 423.75 424 424.25 424.5 424.75 425 425.25 425.5 425.75 426 426.25 426.5 426.75 427 427.25 427.5 427.75 428 428.25 428.5 428.75 429 429.25 429.5 429.75 430 430.25 430.5 430.75 431 431.25 431.5 431.75 432 432.25 432.5 432.75 433 433.25 433.5 433.75 434 434.25 434.5 434.75 435 435.25 435.5 435.75 436 436.25 436.5 436.75 437 437.25 437.5 437.75 438 438.25 438.5 438.75 439 439.25 439.5 439.75 440 440.25 440.5 440.75 441 441.25 441.5 441.75 442 442.25 442.5 442.75 443 443.25 443.5 443.75 444 444.25 444.5 444.75 445 445.25 445.5 445.75 446 446.25 446.5 446.75 447 447.25 447.5 447.75 448 448.25 448.5 448.75 449 449.25 449.5 449.75 450 450.25 450.5 450.75 451 451.25 451.5 451.75 452 452.25 452.5 452.75 453 453.25 453.5 453.75 454 454.25 454.5 454.75 455 455.25 455.5 455.75 456 456.25 456.5 456.75 457 457.25 457.5 457.75 458 458.25 458.5 458.75 459 459.25 459.5 459.75 460 460.25 460.5 460.75 461 461.25 461.5 461.75 462 462.25 462.5 462.75 463 463.25 463.5 463.75 464 464.25 464.5 464.75 465 465.25 465.5 465.75 466 466.25 466.5 466.75 467 467.25 467.5 467.75 468 468.25 468.5 468.75 469 469.25 469.5 469.75 470 470.25 470.5 470.75 471 471.25 471.5 471.75 472 472.25 472.5 472.75 473 473.25 473.5 473.75 474 474.25 474.5 474.75 475 475.25 475.5 475.75 476 476.25 476.5 476.75 477 477.25 477.5 477.75 478 478.25 478.5 478.75 479 479.25 479.5 479.75 480 480.25 480.5 480.75 481 481.25 481.5 481.75 482 482.25 482.5 482.75 483 483.25 483.5 483.75 484 484.25 484.5 484.75 485 485.25 485.5 485.75 486 486.25 486.5 486.75 487 487.25 487.5 487.75 488 488.25 488.5 488.75 489 4





# Tool trolley 177 with assortment



Das Werkzeug

**NEW!**

*Assistant*<sup>®</sup>

177-7/120

EAN-No. 4000896224173

120

Tool trolley with 120 expert tools!

3/3		
-----	--	--

*Assistant*  
2K-Safety-Insert-System

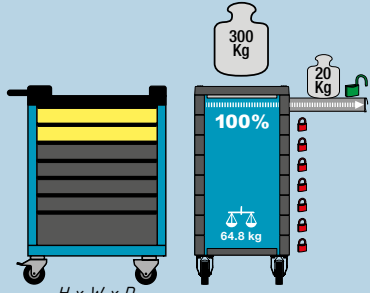

H x W x D:  
780 x 498 x 915 mm



177-7  
**Made in Germany**

163-329/100



163-265/6



163-266/6

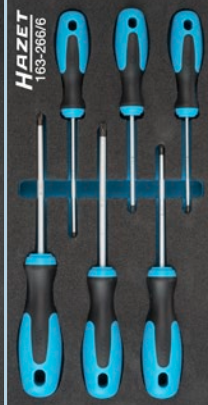

163-292/8



Tool trolley with assortment

*Assistant*<sup>®</sup> 166 N

EAN-No. 4000896004959

24.5 kg



h x w x d:  
965 x 680 x 350 mm



Pillars can swing down to minimum height (500 mm) for space saving transport

**Made in Germany**

*Assistant*<sup>®</sup> 166 C

EAN-No. 4000896072286

27.6 kg



h x w x d:  
1002 x 725 x 398 mm



Pillars can swing down to minimum height (647 mm) for space saving transport

**Made in Germany**

3/3		
-----	--	--



Das Werkzeug

# Multi Table | Service trolley



**Assistant®**

**167 T**

EAN-No. 4000896210503

**Assistant**  
 2K-Safety-Insert-System

3/3+	
------	--

## Multi Table

- Fits under vehicles with a ground clearance greater than 130 mm
- Maximum loading capacity (dynamic): 150 kg

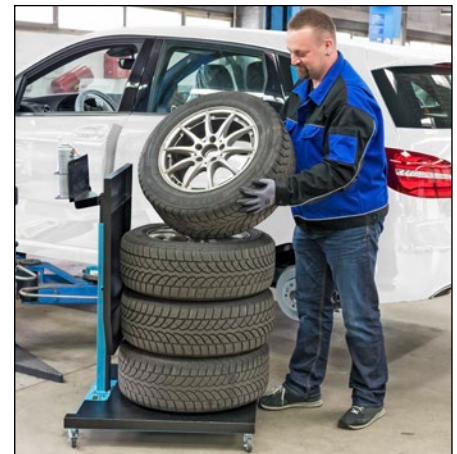
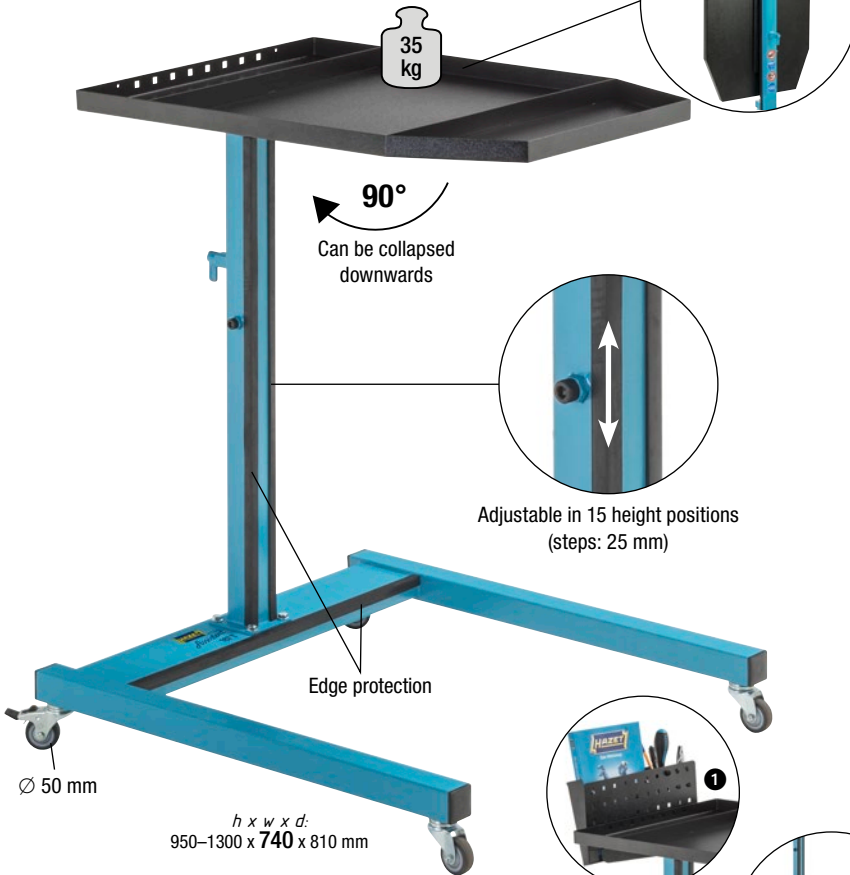

Supplied without pictured tools and accessories

## Multi Table 167 T accessories

	HAZET No.	Designation	EAN-No. 4000896 +
1	167T26	Perforated tool panel for 167 T	209996
2	167T23	Storage board for 167 T	209972

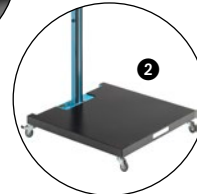

YouTube clip



Made in Germany



**Assistant®**

**167-3**

EAN-No. 4000896205332

## Service trolley

- Flexible and stable for all purposes
- More layers and anti-slipping mats are optionally available

**Assistant**  
 2K-Safety-Insert-System

3x	3/3+
----	------

Suitable for 3/3+ inserts per base

**Assistant®**

**167-3S**

EAN-No. 4000896207206

- Individual fastening options thanks to rectangular perforation on side panels

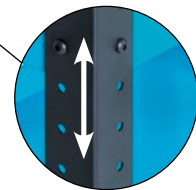
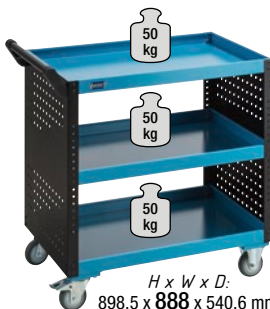

Adjustable in 15 height positions

YouTube clip



Made in Germany

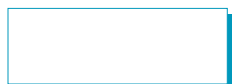

Made in Germany

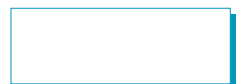





# Tool trolley / Work bench accessories



Das Werkzeug

## Assistant® Accessories

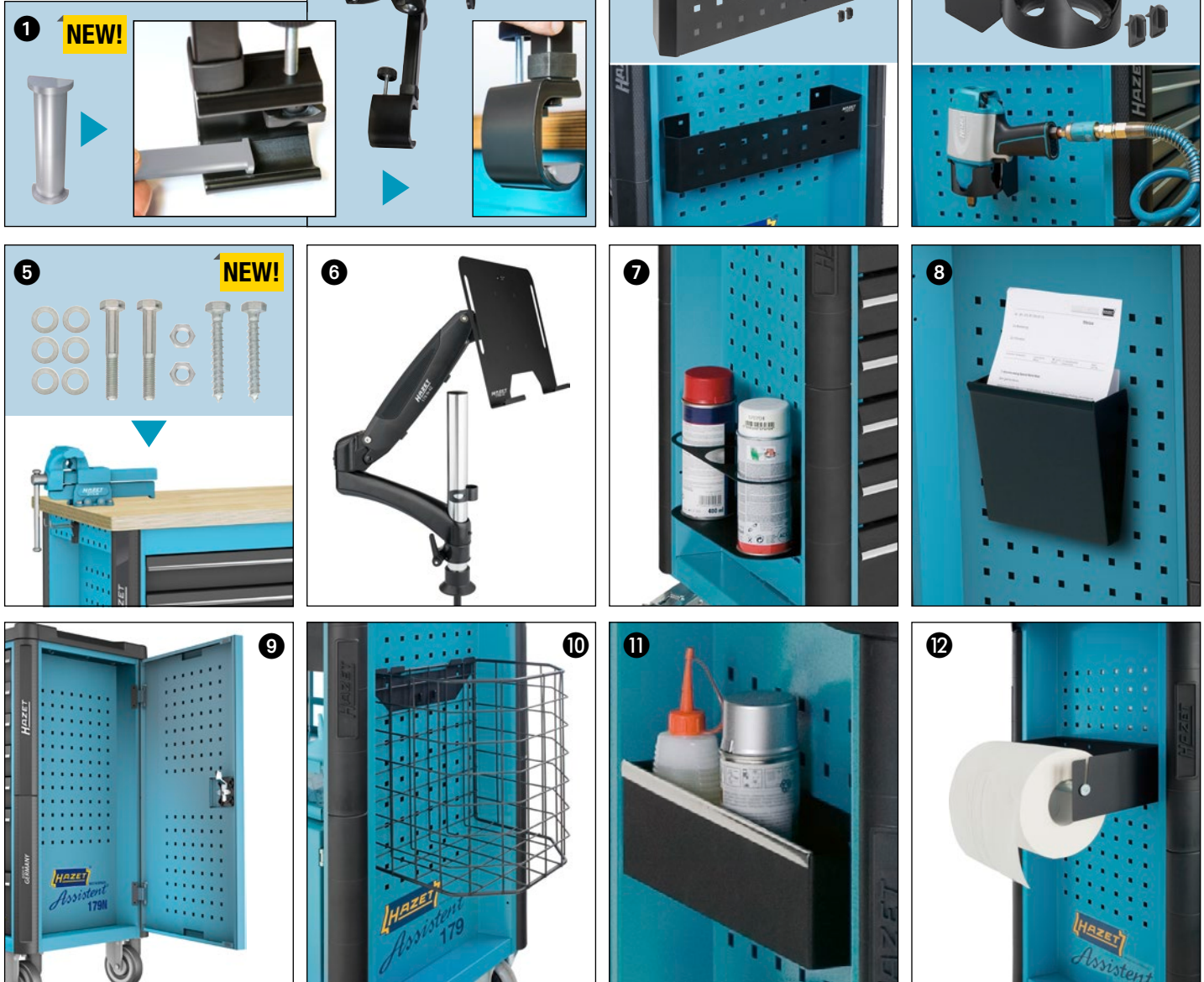

	HAZET No.	Designation		EAN-No. 4000896 +
1	179-45	Adapter for tray holder 179 N-45	NEW!	224005
2	179 N-45	Tray holder	NEW!	224210
3	179 N-35	Can holder	NEW!	224258
4	179 N-46	Impact wrench holder	NEW!	224265
5	179 NW-11	Machinist's vice fastening set	NEW!	221967
6	179 N-42	Laptop holder for 179 N, 179 N X, 179 N XL, 179 N XXL		215621
7	179-35	Can holder		141074
8	180-24	Document holder		110827
9	179 N-21	Side door for 179 N, 179 N X, 179 N XL, 179 N XXL		215553
10	180-33	Paper bin		120833
11	179-28	Tool bin		141234
12	180-34	Holder for paper reel		120840
13	179 N-19	Small parts collector		214457
14	179 N-26	Perforated tool panel for 179 N, 179 N X		215522
15	179 N XL-26	Perforated tool panel for 179 N XL		215539
16	179 N XXL-26	Perforated tool panel for 179 N XXL		215546

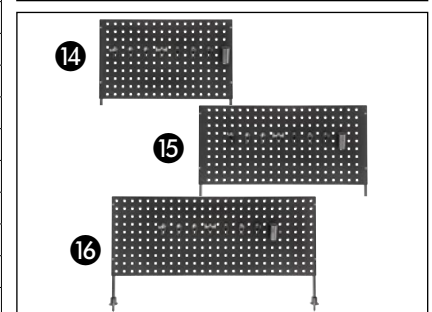



Das Werkzeug

# Tool modules



**163-95/8** 8  
 EAN-No. 4000896145669  
**Double open-end wrench set**

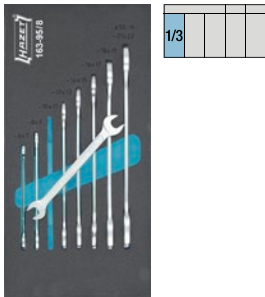

s 6 x 7 – 21 x 22 mm

**Made in Germany**



**163-292/8** 8  
 EAN-No. 4000896186372  
**Combination wrench set**

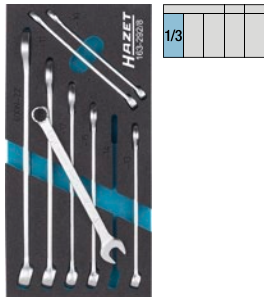

s 10 – 22 mm

**Made in Germany**



**163-519/12** 12  
 EAN-No. 4000896218684  
**Double open-end wrench set**

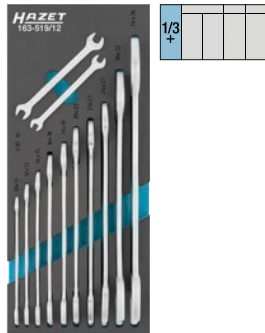

s 6 x 7 – 34 x 36 mm

**Made in Germany**



**163-98/17** 17  
 EAN-No. 4000896145690  
**Combination wrench set**



s 6 – 24 mm

**Made in Germany**



**163-99/18** 18  
 EAN-No. 4000896145706  
**Combination wrench set**



s 6 – 27 mm

**Made in Germany**



**163-97/6** 6  
 EAN-No. 4000896145683  
**Ratcheting combination wrench set**

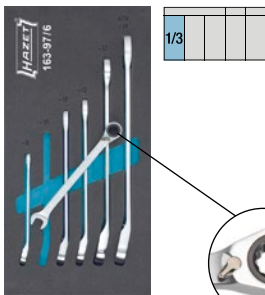

s 8 – 19 mm

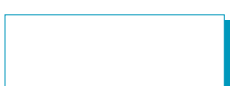

**163-385/12** 12  
 EAN-No. 4000896196944  
**Ratcheting combination wrench set**

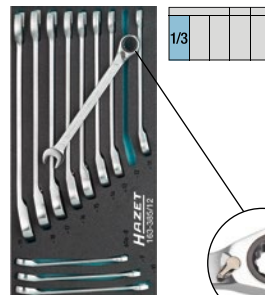

s 8 – 19 mm

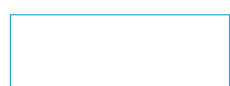

**163-515/16** 16  
 EAN-No. 4000896218721  
**Ratcheting combination wrench set**

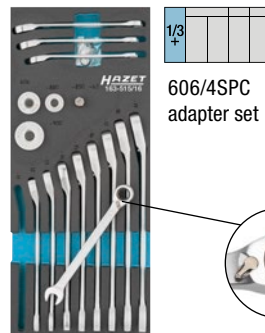

s 8 – 19 mm

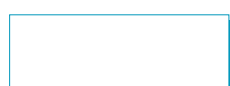

**163-186/16** 16  
 EAN-No. 4000896162253  
**Ratcheting combination wrench set**



s 8 – 19 mm



**163-366/18** 18  
 EAN-No. 4000896196920  
**Ratcheting combination wrench set**

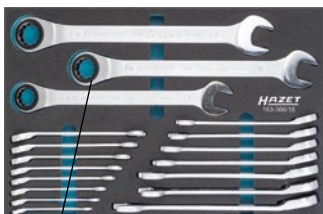

s 8 – 32 mm

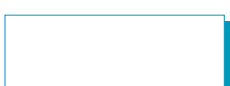

**163-518/9** 9  
 EAN-No. 4000896218707  
**Double box-end wrench set, offset**

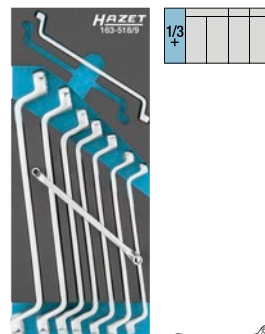

s 6 x 7 – 21 x 23 mm

**Made in Germany**

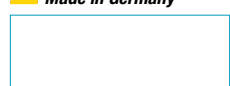

**163-296/7** 7  
 EAN-No. 4000896186655  
**Double box-end wrench set, offset**

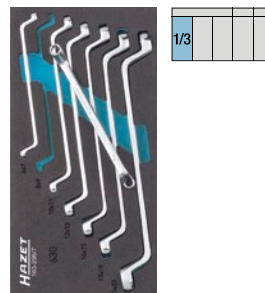

s 6 x 7 – 21 x 23 mm

**Made in Germany**

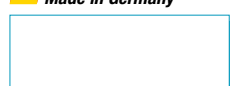

**163-101/9** 9  
 EAN-No. 4000896145720  
**Double box-end wrench set, offset**



s 6 x 7 – 21 x 23 mm

**Made in Germany**

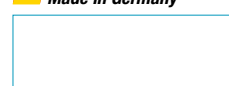







Das Werkzeug

# Tool modules



**163-138/77**  
 EAN-No. 4000896151875  
**Socket set**

**77**



3/3			
-----	--	--	--

- 6.3 1/4 s 4 – 14 mm
- 12.9 1/2 s 10 – 32 mm

**Made in Germany**



**163-490/60**  
 EAN-No. 4000896208111  
**Socket set**

**60**



1/3			
-----	--	--	--

- 6.3 1/4 s 3 – 14 mm, short
- PH 1, 2, 3
- PZ 1, 2, 3
- 0.8 x 4, 1 x 5.5, 1.2 x 8 mm
- E4 – E10, s 4 – 13 mm, long
- T8 – T40, s 3 – 8 mm

**Made in Germany**



**163-483/33**  
 EAN-No. 4000896207770  
**Socket set**

**33**



1/3			
-----	--	--	--

- 10 3/8 s 6 – 22 mm, short
- s 5 – 10 mm,
- s 12 – 19 mm, long

**Made in Germany**

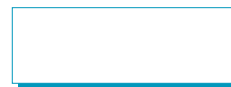

**163-489/28**  
 EAN-No. 4000896207794  
**Socket set**

**28**



1/3			
-----	--	--	--

- 10 3/8 s 6 – 22 mm, short
- s 10 – 20 mm, long

**Made in Germany**



**163-259/14**  
 EAN-No. 4000896179558  
**12-point socket set**

**14**



1/3			
-----	--	--	--

- 10 3/8 s 9 – 22 mm

**Made in Germany**



**163-302/6**  
 EAN-No. 4000896190348  
**Screwdriver socket set**

**6**

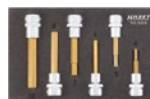

1/9			
-----	--	--	--

**TIN**

- 10 3/8 s 4 – 10 mm

**Made in Germany**



**163-459/15**  
 EAN-No. 4000896204649  
**Socket set, long**

**15**



1/3			
-----	--	--	--

- 12.9 1/2 s 10 – 32 mm

**Made in Germany**

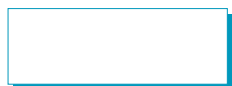

**163-221/10**  
 EAN-No. 4000896168262  
**XZN screwdriver socket set**

**10**



1/3			
-----	--	--	--

**TIN**

- 12.9 1/2 M 8 – M 18

**Made in Germany**



**163-243/7**  
 EAN-No. 4000896178032  
**XZN screwdriver socket set**

**7**



1/9			
-----	--	--	--

**TIN**

- 12.9 1/2 M 6 – M 18

**Made in Germany**



**163-482/15**  
 EAN-No. 4000896207787  
**XZN screwdriver socket set**

**15**



1/3			
-----	--	--	--

**TIN**

- 12.9 1/2 M 5 – M 18, short
- M 8 – M 14, long

**Made in Germany**



**163-220/13**  
 EAN-No. 4000896168286  
**Screwdriver socket set**

**13**



1/3			
-----	--	--	--

**TIN**

- 12.9 1/2 s 5 – 19 mm
- s 6 – 10 mm

**Made in Germany**



**163-463/15**  
 EAN-No. 4000896205066  
**Impact socket set**

**15**



1/3			
-----	--	--	--

- 12.9 1/2 s 17 – 27 mm
- s 17 – 27 mm,

**Made in Germany**



**163-217/6**  
 EAN-No. 4000896168231  
**Adapter set**

**6**



1/9			
-----	--	--	--

- 6.3 1/4 10 3/8 12.9 1/2 20 3/4

**Made in Germany**



**163-492/22**  
 EAN-No. 4000896208081  
**TORX® screwdriver socket set**

**22**



1/3			
-----	--	--	--

**TIN**

- 12.9 1/2 T20 – T60, short
- T30 – T70, long
- T30H – T55H

**Made in Germany**







# Tool modules



Das Werkzeug

**163-192/24**  
EAN-No. 4000896162314  
**TORX®**  
socket set

24

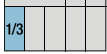
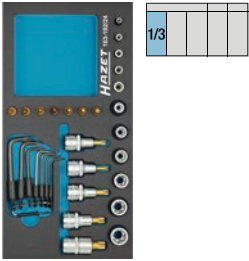

6.3 ¼ 12.5 ½ T8 - T55  
E5 - E20

Made in Germany



**163-245/12**  
EAN-No. 4000896178049  
**TORX®**  
tool set

12

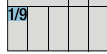
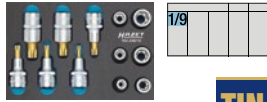

TIN

12.5 ½ E10 - E20  
T30 - T60

Made in Germany



**163-184/6**  
EAN-No. 4000896161461  
**HEXAnamic-**  
screwdriver set

6



4 - 8 mm PH1, PH2



**163-182/9**  
EAN-No. 4000896162352  
**T-handle TORX®**  
screwdriver set

9

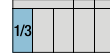
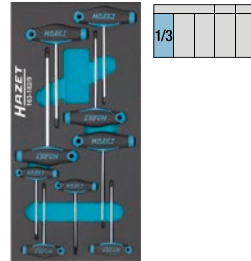

T6 - T30



**163-122/3**  
EAN-No. 4000896153534  
**T-handle 6-point**  
socket set

3

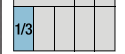
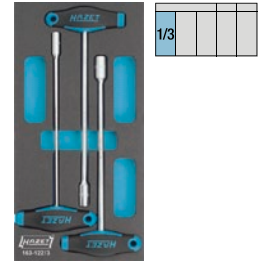

8, 10, 13 mm



**163-461/5**  
EAN-No. 4000896204625  
**Flexible 6-point**  
socket set

5

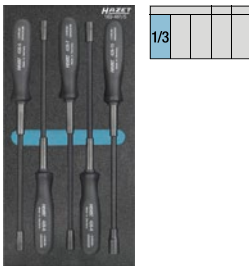

5 - 10 mm

Made in Germany



**163-265/6**  
EAN-No. 4000896180608  
**Screwdriver set**

6



3 - 6,5 mm PH1 PH2



**163-516/10**  
EAN-No. 4000896218738  
**Screwdriver set**

10

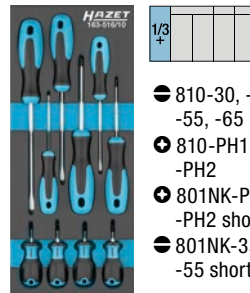

- 810-30, -40, -55, -65
- 810-PH1, -PH2
- 801NK-PH1, -PH2 short
- 801NK-35, -55 short



**163-266/6**  
EAN-No. 4000896180615  
**TORX®** screwdriver set

6

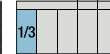
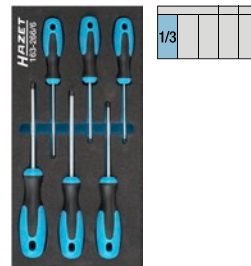

T10 - T30



**163-264/5**  
EAN-No. 4000896180592  
**Screwdriver set**

5

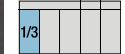
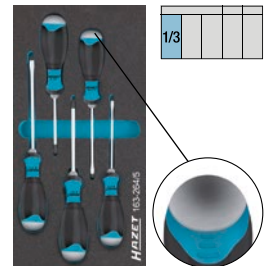

4,5 - 7 mm PH1 PH2



**163-522/6**  
EAN-No. 4000896218660  
**Screwdriver set**

6

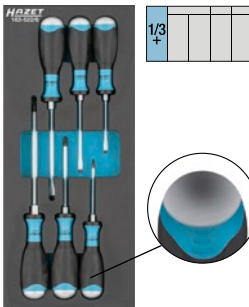

810U-45, -55, -70  
810U-PH1, -PH2, -PH3

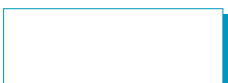

**163-297/26**  
EAN-No. 4000896186242  
**Screwdriver set**

26



3, 4, 5 mm

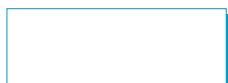

**163-299/8**  
EAN-No. 4000896186723  
**Drift pin set**

8

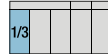

- 3 - 6 mm
- 3 - 8 mm
- 320 mm, 500 g

Made in Germany

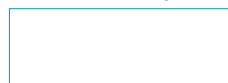

**163-517/15**  
EAN-No. 4000896218745  
**Electronic**  
screwdriver set

15

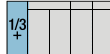
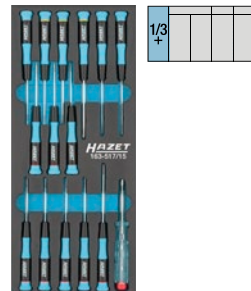

839-1 808 T5 - T15  
805-015 - 030  
805 PH-00 - PH-1

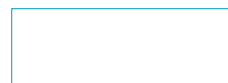

**163-523/11**  
EAN-No. 4000896218714  
**Tool set**

11

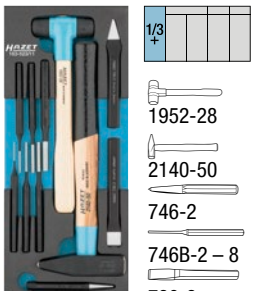

- 1952-28
- 2140-50
- 746-2
- 746B-2 - 8
- 730-3
- 740-3

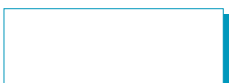



Das Werkzeug

# Tool modules



163-524/31

EAN-No. 4000896218653

## Screwdriver set

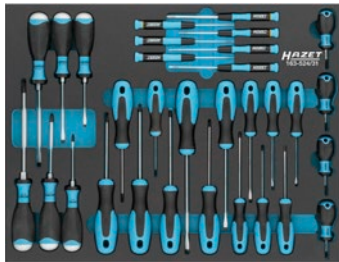

3/3+

- 810U-45 – 70 ● -PH1 – PH3 ○ 810-T10 – T30
- 810-25 – 65 ● -PH0 – PH2
- 801NK-35 – 55 ● -PH1, -PH2
- 805-015 – 030 ● -PH00 – PH1



31

163-526/41

EAN-No. 4000896218646

## Screwdriver set



3/3+

- 810U-45 – 70 ● -PH1 – PH3
- 810-T10 – T30 ● 810-25 – 65
- 810-PH0 – PH2 ● 801NK-35 – 55
- 801NK-PH1 – PH2 ○ 2105LG-015 – 10
- 2116LG-T9 – T40



41

163-141/31

EAN-No. 4000896151905

## Screwdriver set



3/3+

- 802-0,6x3,5 – 2,0x12 mm ● PH1 – PH3
- 803-T6 – T30 mm ○ 2105LG-s1,5 – 10 mm
- 801NK-55, -PH1 – PH2



31

163-527/56

EAN-No. 4000896218691

## Screwdriver set



4/3+

- 810U-45 – 70 ● -PH1 – PH3 ○ 810-T10 – T30 ● 810-25 – 65
- 810-PH0 – PH2 ● 801NK-35 – 55 ● -PH1, -PH2
- 805-015 – 030, PH00 – 1 ○ 2116LG-T9 – T40
- 2105LG-015 – 10 ● 839-1 ○ 808-T5 – T15



56

163-269/3

EAN-No. 4000896180776

## Pliers set



1/3

Made in Germany



3

163-424/9

EAN-No. 4000896202546

## Pliers set



2/3

Made in Germany



9

163-124/4

EAN-No. 4000896153602

## Pliers set for circlips



1/3

- 1x ● Form A 19 – 60 mm,
- 1x ● Form A 19 – 60 mm,
- 1x ○ Form C 19 – 60 mm,
- 1x ○ Form D 19 – 60 mm

Made in Germany



4

163-425/3

EAN-No. 4000896202614

## Hose clamp pliers set



1/3

- sb 35 mm
- sb 27 mm
- sb 40 mm

Made in Germany



3

163-464/3

EAN-No. 4000896205059

## Hammer set



1/3

- 400 g
- Ø 28 mm
- 1000 g

Made in Germany



3

163-330/16

EAN-No. 4000896191826

## Tool set



- 810-0,5 x 3,0 – 1,2 x 6,5 mm
- 810 PH 1, PH 2
- 810 T10 – T30
- 320 mm, 500 g



16

163-31/27

EAN-No. 4000896118618

## Tool set



- 803-0,4 x 2,5 – 1,2 x 8
- 801NK-55, -PH-2
- PH 1, PH 2 ○ T 10 – T 30
- s 3, 6 mm
- 320 mm, 500 g 746-1
- 760-2 1802 M-22 1841 M b-33 1850 M-22



27







# Sanitation set Combination wrenches

1520/29

EAN-NO. 4000896213429

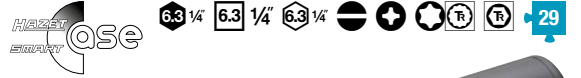

## Sanitation / Heating tool set

- Compact, special tool set for the areas of sanitation, heating, air-conditioning and solar installations
- Operating tools designed for use in narrow and low-lying work areas
- Safe working in high-voltage areas thanks to tested VDE tools (up to 1000 V)

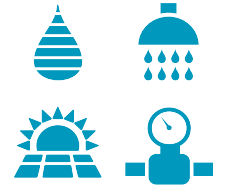
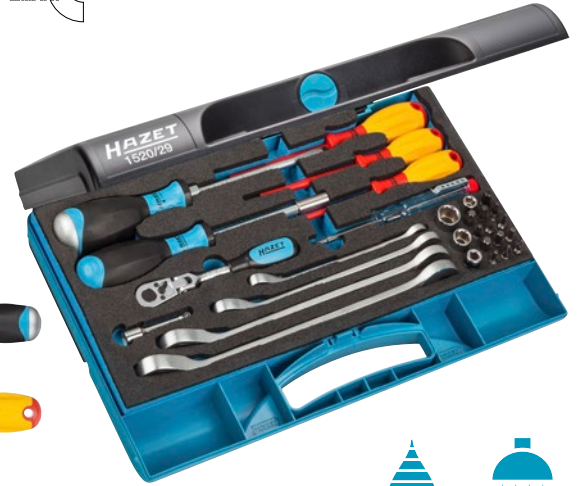
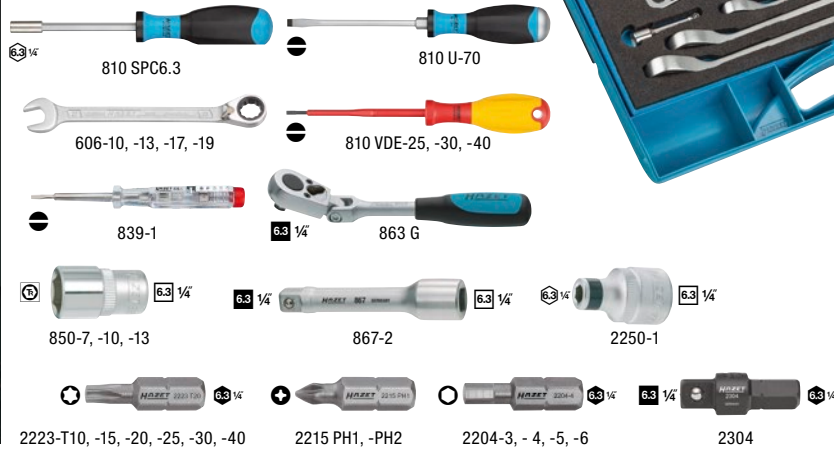

## 600 SPC Combination wrench sets

Made in Germany

HAZET No.	Contents	EAN-No. 4000896 +
600 SPC/10	s8 · 10 · 12 · 13 · 14 · 15 · 16 · 17 · 18 · 19 mm	118465
600 SPC/16	s7 · 8 · 9 · 11 · 10 · 12 · 13 · 14 · 15 · 16 · 17 · 18 · 19 · 21 · 22 · 24 mm	186235

## Combination wrench, extra long, slim design

600 Lg/10

EAN-No. 4000896218424

600 Lg/13

EAN-No. 4000896218417

YouTube clip



Extra long!

s 10 · 11 · 12 · 13 · 14 · 15 · 16 · 17 · 18 · 19 mm



Made in Germany

s 10 · 11 · 12 · 13 · 14 · 15 · 16 · 17 · 18 · 19 · 21 · 22 · 24 mm



Made in Germany





Das Werkzeug

# Screwdriver



810S/6

EAN-No. 4000896224166

## Slotted screwdriver set

NEW!

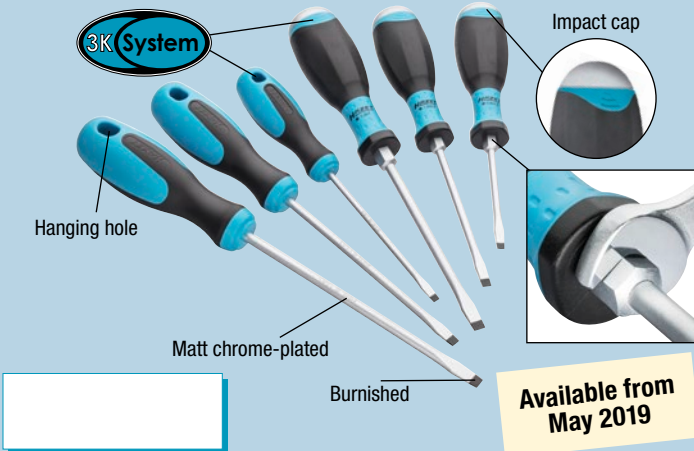

3 x		810	0.8 x 4.0 · 1.0 x 5.5 · 1.2 x 6.5 mm
3 x		810 U	0.8 x 4.5 · 1.0 x 5.5 · 1.2 x 7 mm

Available from May 2019

810/6

EAN-No. 4000896058808

## Screwdriver set



4 x		PH1 · PH2	0.5 x 3.0 · 0.8 x 4.0 · 1.0 x 5.5 · 1.2 x 6.5 mm
2 x		PH1 · PH2	

810/6 PZ

EAN-No. 4000896217984

## Screwdriver set

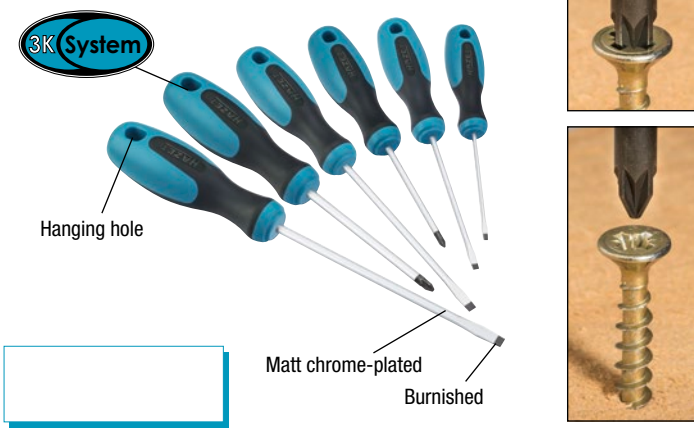

4x		PZ 1 · PZ 2	0.5x3.0 · 0.8x4.0 · 1.0x5.5 · 1.2x6.5 mm
2x		PZ 1 · PZ 2	

810 T/6

EAN-No. 4000896204304

## TORX® screwdriver set



6 x		T10 · T15 · T20 · T25 · T27 · T30	
-----	--	-----------------------------------	--

810 U-1/5

EAN-No. 4000896179572

## Screwdriver set with impact cap



3 x		PH1 · PH2	0.8 x 4.5 · 1.0 x 5.5 · 1.2 x 7 mm
2 x		PH1 · PH2	

802/5,

EAN-No. 4000896147359

## HEXAnamic professional screwdriver set



3 x		PH1 · PH2	0.8 x 4.0 · 1.0 x 5.5 · 1.2 x 6.5 mm
2 x		PH1 · PH2	







**810 BH**  
 EAN-No. 4000896217175



**Insert tool holder for bits**

- With bayonet fitting
- Versatile and flexible for home and workshop
- Non-slip HAZET 3-component handle – allows high power transmission
- Perfect for supplementing HAZET bit sets
- No annoying rolling away thanks to special design
- Total length: 132.5 mm
- Handle length: 110 mm



**810 MGT**  
 EAN-No. 4000896217960

**Magnetising / demagnetising tool**

- For magnetising screwdrivers, tools and small parts containing iron
- Holds screws and other small parts containing iron securely on the tool after magnetisation
- Magnetisation restored by sliding multiple times
- Compact design in HAZET logo form
- Easy application

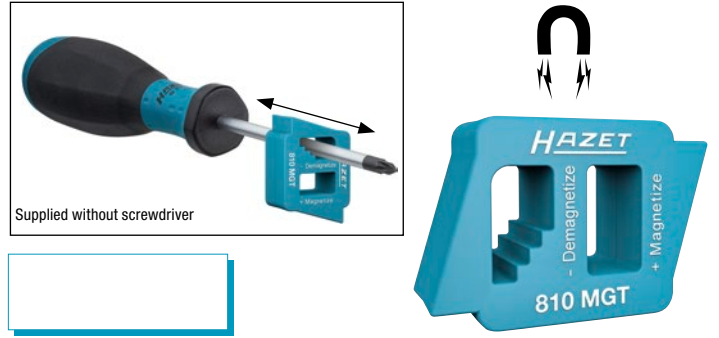

**Universal pliers with quick-adjust lever**

- Adjustment without re-gripping
- Max. hexagon size up to s 50 mm, round pipes up to a max. of 50 mm Ø
- Size 1 1/8" = 47,2 mm (British Standard Whitworth Thread)
- DIN ISO 8976



Made in Germany

HAZET No.	Description	EAN-No. 4000896 +
760-2	Universal pliers for right-handed people	188451
760 L-2	Universal pliers for left-handed people	191291

**2240 N/36** 36  
**BitE box**



**2240 N/51** 51  
**BitE box**



Made in Germany

	0.6 x 4.5	0.8 x 5.5	1 x 6 mm	0.5 x 4	0.6 x 4.5	0.8 x 5.5	1 x 6 mm
	PH 1 (3x)	PH 2 (3x)	PH 3 (1x)	PH 1 (4x)	PH 2 (4x)	PH 3 (2x)	
	PZ 1 (3x)	PZ 2 (3x)	PZ 3 (1x)	PZ 1 (3x)	PZ 2 (3x)	PZ 3 (1x)	
	s 3	4	5	6 mm	s 2	2.5	3
	T 10	T 27		T 6	T 7	T 8	T 9
	T 15	T 20	T 25	T 30	T 40 (all 2x)	T 15	T 20
	T 20H	T 30H		T 10H	T 15H	T 20H	T 25H
	D 6.3 = 1/4"	C 6.3		D 6.3 = 1/4"	C 6.3		
<b>EAN-No. 4000896 +</b>	187614			187607			

**986/9N**  
 EAN-No. 4000896193530



**Screwdriver socket set with TIN coated blades**

- 1.27 kg

Top seller!

Made in Germany



With SmartCase (1/9)

L x W x H:  
 165 x 153 x 52 mm

HAZET No.	Contents
986/9 N	s 5, 6, 7, 8, 9, 10, 12, 14, 17 mm

**992/9**  
 EAN-No. 4000896051540



**TORX® Screwdriver socket set with TIN coated blades**

- 1.41 kg

Made in Germany



With SmartCase (1/9)

L x W x H:  
 165 x 153 x 52 mm

HAZET No.	Contents
992/9	T 20, T 25, T 27, T 30, T 40, T 45, T 50, T 55, T 60



Das Werkzeug

# Fine-tooth reversible ratchet



916 HP

EAN-NO. 4000896213894

**HiPer**  
HIGH PERFORMANCE

12<sup>5</sup> 1/2"

## Fine-tooth reversible ratchet

- Small operating angle (4°) enables even better use in the tightest of spaces
- 90 teeth, 4° fine teeth for confined spaces
- Engaging function of the lever provides protection against unwanted switching
- A lot more performance with the same dimensions
- Increased service life thanks to the use of state-of-the-art lubricants in the ratchet mechanism
- Strict production tolerances ensure protection against penetration by dirt.
- HAZET internal quality standards guarantee durability way beyond what you would normally expect.
- Chrome-plated surface: high-quality, easy to clean, corrosion resistant
- Length: 275 mm
- Weight: 595 g

**Power and precision in perfect symbiosis!**

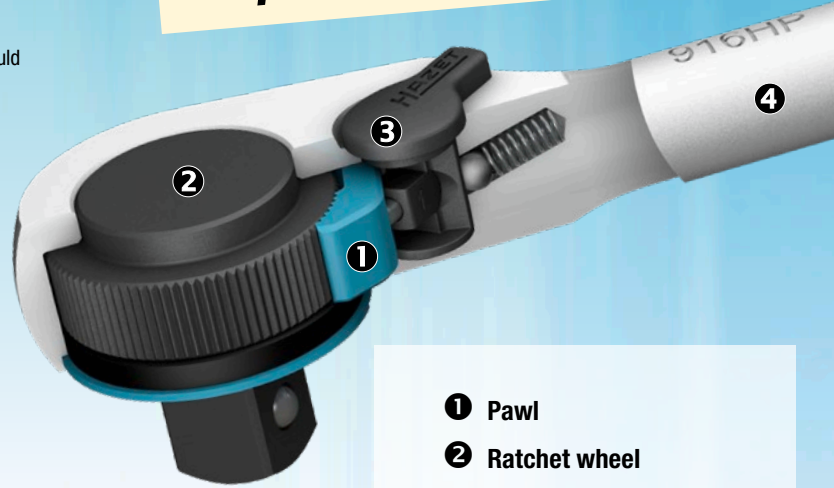

- ① Pawl
- ② Ratchet wheel
- ③ Shift lever
- ④ Housing
- ⑤ 2-component handle

**Strongest HAZET ratchet ever!**

**10000 Nm**



YouTube clip



**Made in Germany**

\*According to DIN 3122:2017-04

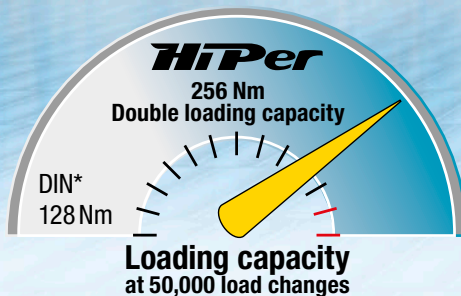
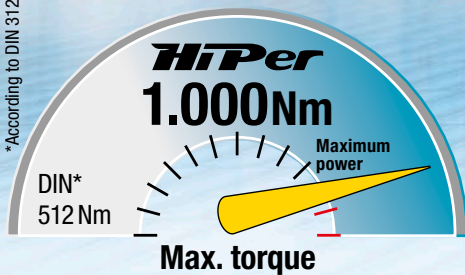





# Socket set



Das Werkzeug

953 HP

EAN-NO. 4000896215188

Socket set



1/3			
-----	--	--	--

Includes **HiPer** HIGH PERFORMANCE ratchet!



1 x		12.5 1/2	916 HP <b>HiPer</b> 1000 Nm
14 x		12.5 1/2	10 · 11 · 12 · 13 · 14 · 15 · 16 17 · 18 · 19 · 21 · 22 · 24 · 27 mm
2 x		12.5 1/2 12.5 1/2	123 · 248 mm
1 x		6.3 1/4	863 P
9 x		6.3 1/4	5 · 6 · 7 · 8 · 9 · 10 · 11 · 12 · 13 mm
1 x		6.3 1/4 6.3 1/4	100 mm
1 x			□ 6.3 = 1/4" ○ 6.3 = 1/4"
1 x			866 U
3 x			0.5 x 4 · 0.6 x 4.5 · 0.8 x 5.5 mm
2 x			PH 1 · PH 2
2 x			PZ 1 · PZ 2
5 x			s 2 · 3 · 4 · 5 · 6 mm
5 x			T10 · T15 · T20 · T25 · T30

Made in Germany

[www.hazet.de/fan-shop](http://www.hazet.de/fan-shop)

# YOUR HAZET FAN SHOP!

- FAN ARTICLES
- HAZET LINE
- RACING TOOL LINE
- FASHION





Das Werkzeug

# Torque technology



## SmartTAC System 7000 sTAC

Electronic torque wrench with built-in angle gauge for highly precise screwing applications with Smart technology – Ready for Industry 4.0

- Totally new concept now enables even the smallest torque wrenches with built-in angle gauge from 1 Nm thanks to redesign of the PCB with a spatial requirement reduced by 42 %
- **HAZET Smart Technology** consisting of **designed and developed SmartTAC App and Low Energy Bluetooth** interface (may be subject to national approval restrictions) with problem-free LIVE data exchange for displaying the screwing progress on mobile end devices such as smartphone (Smartwatch) and tablet PC as well as via a USB-C interface for programming the torque rotation angle wrench and documentation of the screwing data via laptop and PC.
- Large, high-contrast illuminated, easily readable OLED display, 180° rotation



SmartTAC Apps



Available for:  
 DESKTOP PC · ANDROID · iOS

Display and membrane keyboard  
 spray-water-proof



### Functions

### 7000 - 2 sTAC top version

Display deviation in right and left torque	± 1 % ; ± 1 digit (7280/7281 ± 2 %; ± 1 digit)
Display deviation in right and left rotation angle	± 1 % ; ± 1 °
Rotation angle range adding	0 - 999 °
Torque tolerance for OK display (green)	Adjustable ± 1 to 10 %
Rotation angle tolerance for OK display (green)	Adjustable 1 - 90 °
Choice of torque units	Nm, lbf ft, lbf in or kgf m
Effective length adjustable 0 - 250 mm	x
Threshold value, pre-warning level	Adjustable 50 - 99 %
Adjustable signaling, On / Off audible signal (buzzer) on/off and vibration	x
Reset function, restore to factory setting	x
Stand by time	Adjustable 1 - 10 min.
Memory capacity incl. date and time	Up to 2500 measurements
Offers possibility to program flow charts and sets of parameters	25 and 25
2 control functions: programmable torque control for angle tightening and angle control for torque tightening	x
Menu locking against unintentional change, four-digit code is personally selected	x
Display of the software version with serial number, calibration date and service display / usage counter	x
Menu languages	German, English, French, Italian, Chinese
Optional on request	Programming and evaluation software for laptop and PC SmartTAC app for Android end devices
In preparation	SmartTAC App for IOS (Apple) end devices, data exchange via WLAN RFID chip for code identification







# Torque technology



- Suitable, amongst other applications, for all screw connections with torque/ rotation angle calling for high accuracy or mandatory documentation, e.g. engine components in particular cylinder head bolts, mechanical engineering with increased requirements (including robot technology)
- **Unique ergonomic, user-oriented HAZET design of the entire tool for professional use**
- The reduction in size, owing to the 42% smaller size of the PCB as well as partial integration of the PCB into the main pipe, results in dimensions that allow the small torque wrench with built-in angle gauge from 1 to 10 Nm for the first time
- Spray-water-proof via membrane keyboard – Protection type IP 54
- Tested in accordance with DIN EN ISO 6789-2:2017
- **USB-C** interface for programming torque wrenches with built-in angle gauge and for documentation of the storage data via laptop and PC
- Incl. standard **replaceable Li ion rechargeable battery**, type 14650 / 3.7 Volt, can be charged directly on the tool via USB-C connector
- Incl. 1 m USB 3.1 / A - C cable

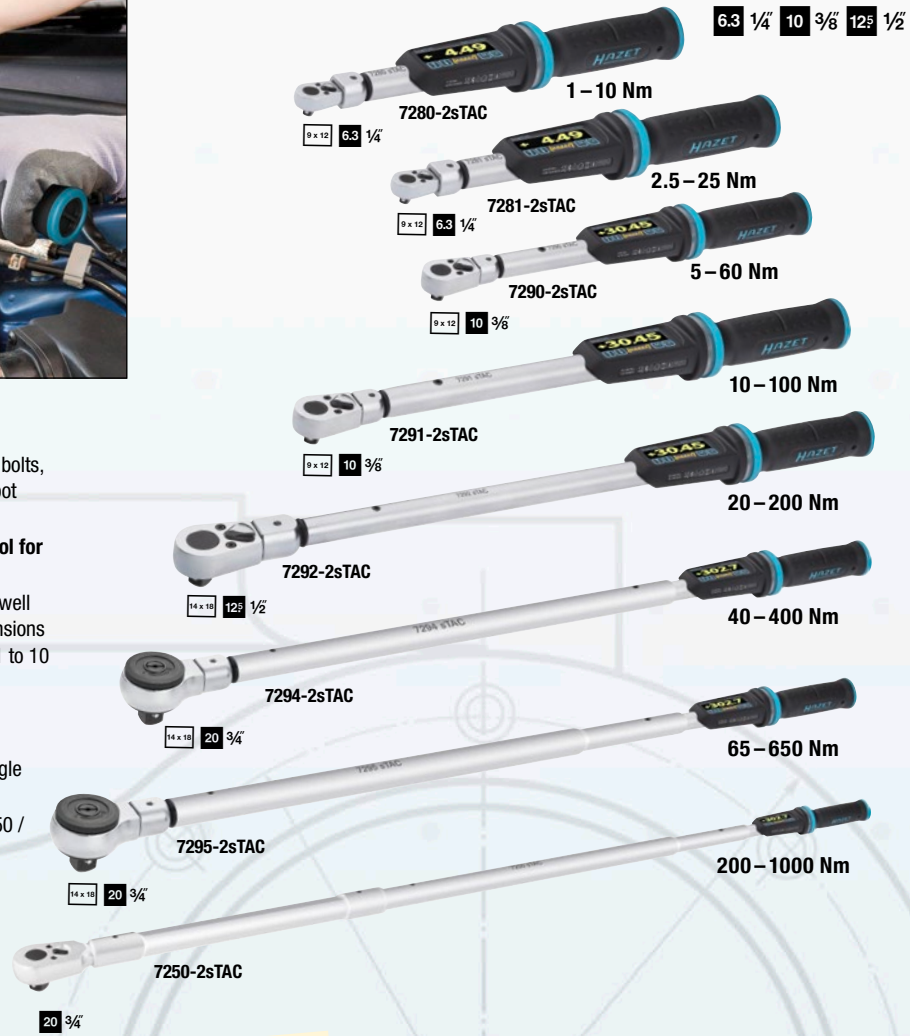

YouTube clip

**8 sizes for torque ranges from 1 to 1,000 Nm! SmartTAC for countries without Bluetooth licence on demand!**

**Made in Germany**

**Made in Germany**

HAZET No.		Torque measuring range Nm	Torque display range Nm	Scale graduation / Torque setting steps	Insert square holder	HAZET insert reversible ratchet (Included in delivery)	Length approx. mm without/with insert tool	approx. kg	Operating force approx. kg	EAN-No. 4000896 +	
7280-2sTAC	✓	1 – 10 ±2	0.5 – 10	To 50 Nm = 0.1 50 – 100 Nm = 0.5 From 100 Nm = 1.0	9 x 12	6401-1 – <b>6.3</b> 1/4	260 / 290.5	0.4	0.5 – 4.6	215294	
7281-2sTAC	✓	2.5 – 25 ±2	1.25 – 25		9 x 12		260 / 290.5	0.4	1.1 – 11.4	215317	
7290-2sTAC	✓	5 – 60 ±1	2.5 – 60		9 x 12	6402-1 – <b>10</b> 3/8	302 / 347	0.8	1.8 – 22.2	215324	
7291-2sTAC	✓	10 – 100 ±1	5 – 100		9 x 12		383 / 428	0.9	2.9 – 28.7	215430	
7292-2sTAC	✓	20 – 200 ±1	10 – 200		14 x 18	6404-1 – <b>12.5</b> 1/2	520 / 578.5	1.3	4.1 – 40.7	215447	
7294-2sTAC	✓	40 – 400 ±1	20 – 400		14 x 18	6406 – <b>20</b> 3/4	945 / 1021	3.2	4.4 – 43.8	215454	
7295-2sTAC	✓	65 – 650 ±1	32.5 – 650		14 x 18		1141 / 1217	5.9	5.9 – 58.7	215461	
7250-2sTAC	✓	200 – 1000 ±1	100 – 1000		–	<b>20</b> 3/4	Permanently mounted reversible ratchet	1772 (Overall length)	9.0	12.2 – 60.8	215478
7910-sTAC		<b>SmartTAC-Tool, programming and analysis software</b>								221875	<b>NEW!</b>





Das Werkzeug

# Torque technology



## SYSTEM 5000-3CT

6.3 1/4" 10 3/8" 12.5 1/2" 20 3/4"

**NEW!**

Made in Germany

### Technology up to date!

Third generation of torque wrenches 5000-3CT:  
 Now even more powerful and precise!



**Extended programme:  
 Measuring range to 800 Nm**

**± 3% release accuracy tolerance**  
 (5108-3 CT – 5145-3 CT)

### Torque wrench

- No need to reverse the torque wrench to relieve the compression spring
- Recessed zones in the handle ensure optimum force transmission and non-slip finish thanks to more grip
- Adjustment aid with detent points for optimised operator guidance ensures safe and fast adjustment of the desired torque value by turning the handle
- Safe locking of the setting values by latching function on the blue rotary assembly
- Lock symbols indicate the respective locking status
- Can be attached to the cable loop through openings on the blue rotary assembly
- Trigonometric shape of the blue rotary assembly prevents uncontrolled rolling away
- Optimised sealing ring to protect against debris
- Laser lettering of the metallic scale sleeve and scale ensures permanent legibility
- Integrated shift lever with free-running function for the measuring ranges 20 – 320 Nm reduces the risk of injury and malfunction
- Tested according to DIN EN ISO 6789-2:2017 with calibration certificate and serial number
- Outside square according to DIN 3120, ISO 1174-1
- Delivery in sturdy Hexa plastic box

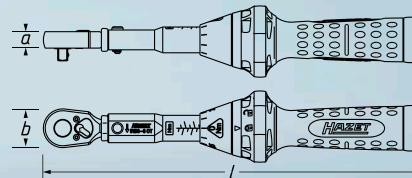
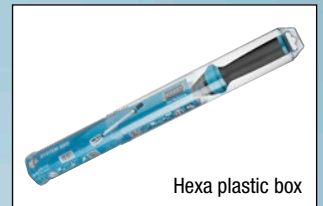

Made in Germany

HAZET No.	Output	l mm	a mm	b mm	Release accuracy tolerance %	Nm	Nm	kg	EAN-No. 4000896 +
5107-3 CT	6.3 1/4"	234	10.2	24	4	1–9	0.1	0.6 – 5.5	218875
5108-3 CT	6.3 1/4"	234	10.2	24	3	2.5–25	0.25	1.4 – 15.3	218882
5110-3 CT	10 3/8"	320	14.5	32	3	10–60	0.5	3.9 – 25.0	218899
5120-3 CT	12.5 1/2"	320	14.5	32	3	10–60	0.5	3.9 – 25.0	218905
5121-3 CT	12.5 1/2"	421	19.6	44	3	20–120	1	6.1 – 38.0	218912
5122-3 CT	12.5 1/2"	519	19.6	44	3	40–200	1	9.4 – 49.5	219001
5123-3 CT	12.5 1/2"	628	19.6	44	3	60–320	2	11.3 – 62.2	218998
5145-3 CT	20 3/4"	1271	28.5	64	3	300–800	2.5	26.2 – 71.0	218929

Detailed description in Tool Catalogue 2019, from page 282





# Pneumatic Tools



Pin clutch mechanism



Single hammer striking mechanism

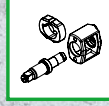

Twin hammer mechanism

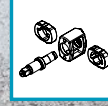

Direct striking mechanism



## Impact wrench

### 9010 T

- Max. loosening torque: 108 Nm



6.3 1/4"

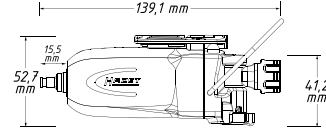
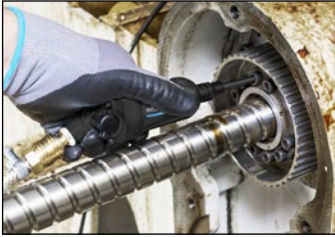

YouTube clip



### 9011 T

- Max. loosening torque: 108 Nm



10 3/8"

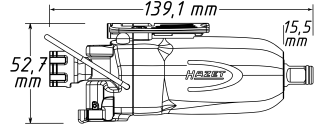

YouTube clip



## Impact wrench

### 9011 M 10 3/8"

- Max. loosening torque: 461 Nm

### 9012 M 12.5 1/2"

- Max. loosening torque: 1,100 Nm

Extra short – only 92 mm!



10 3/8"

12.5 1/2"

YouTube clip

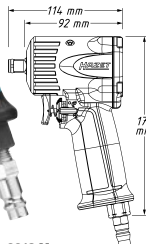

9011 M

9012 M

### 9012 M-S

EAN-NO. 4000896202232

#### Silicone protective cover

- Can be used for 9011 M und 9012 M



### 9012 M-1

- Max. loosening torque: 1,200 Nm



12.5 1/2"

YouTube clip



1,200 Nm – Now even stronger and shorter!

### 9012 M-1-S

EAN-NO. 4000896222735

NEW!

#### Silicone protective cover

- Can be used for 9012 M-1

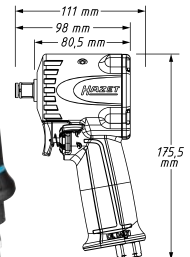

## Mini impact wrench

### 9012 MT

- Max. loosening torque: 1,400 Nm

Extra short – only 100 mm!



12.5 1/2"

YouTube clip

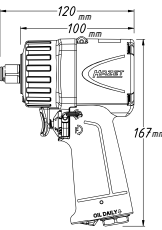

## Angled impact wrench

### 9012 A-1

- Max. loosening torque: 450 Nm

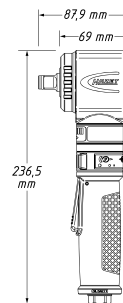

12.5 1/2"

YouTube clip



HAZET No.	EAN-No. 4000896+	■	max. Nm	rpm upm	l/min	dB(A) Lp A	m/s <sup>2</sup>	kg	🔧	🔩	🔩	🔩	🔩
9010 T	203611	6.3 1/4"	108	12.000	59	98	6.74	0.55	-	12,91(+)	7,2	✓	-
9011 T	206230	10 3/8"	108	12.000	59	98	6.74	0.55	-	12,91(+)	7,2	✓	-
9011 M	201570	10 3/8"	461	6.500	85.2	90.3	7.78	1.2	✓	12,91(+)	7,2	-	✓
9012 M	188987	12.5 1/2"	1.100	10.000	127	97	9.57	1.2	✓	12,91(+)	7,2	-	✓
9012 M-1	218356	12.5 1/2"	1.200	8.800	127.4	92.2	13.49	1.27	✓	12,91(+)	7,2	-	✓
9012 MT	203598	12.5 1/2"	1.400	9.000	135	92.7	8.74	1.32	✓	12,91(+)	7,2	-	✓
9012 A-1	218301	12.5 1/2"	450	8.500	113	92.2	9.96	1.16	✓	12,91(+)	7,2	-	✓



Das Werkzeug

# Pneumatic Tools



## Impact wrench

### 9012 SPC

- Max. loosening torque: 850 Nm

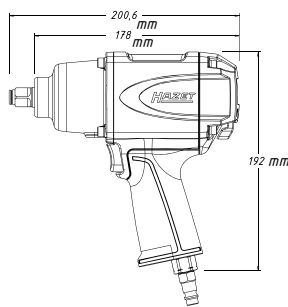

12<sup>5</sup> 1/2"

### 9012 P-1

- Max. loosening torque: 1000 Nm

YouTube clip

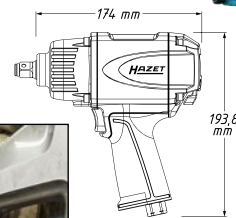

12<sup>5</sup> 1/2"

### 9012 SPC-S

EAN-NO. 4000896222476

#### Silicone protective cover

- Can be used for 9012 SPC, 9012-1SPC, 9012 P-1



NEW!

### 9012 EL-SPC

- Max. loosening torque: 1700 Nm
- One-hand operation through innovative switching on rear of device

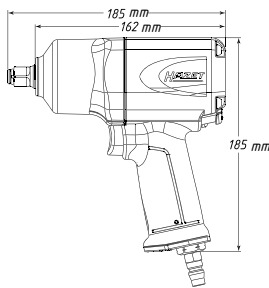

12<sup>5</sup> 1/2"

### 9013 MG

- Max. loosening torque: 1800 Nm

Suitable for commercial vehicles!

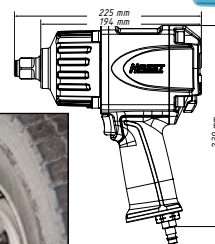

20 3/4"

### 9013 M

- Max. loosening torque: 1890 Nm

3/4" impact wrench in 1/2" size!  
Only 2.1 kg!

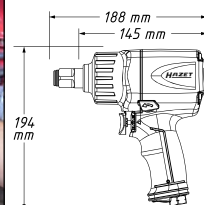
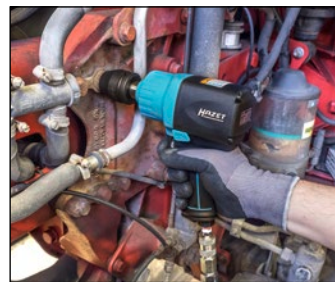

20 3/4"

### 9012 EL-SPC-S

EAN-NO. 4000896222520

#### Silicone protective cover

- Can be used for 9012 EL-SPC



NEW!

HAZET No.	EAN-No. 4000896 +	■	max. Nm	rpm upm	l/min	dB(A) Lp A	m/s <sup>2</sup>	kg	✓	✓	✓	✓		
9012 SPC	119639	12 <sup>5</sup> 1/2"	850	7000	127.4	92.1	7.42	2.6	✓	12.91 (v) 17.2	✓	-	-	-
9012 P-1	212330	12 <sup>5</sup> 1/2"	1000	7500	127	94.4	12.24	2.54	✓	12.91 (v) 17.2	-	-	✓	-
9012 EL-SPC	188444	12 <sup>5</sup> 1/2"	1700	8000	139	98	10.23	1.98	✓	12.91 (v) 17.2	-	-	✓	-
9013 MG	109210	20 3/4"	1800	6100	198	96.8	12.18	5.16	✓	16.41 (v) 17.2	-	-	✓	-
9013 M	212347	20 3/4"	1890	7300	153	104	7.47	2.1	✓	12.91 (v) 17.2	-	-	✓	-

YouTube clip







# Pneumatic Tools

## Impact wrenches

- Max. loosening torque: 3400 Nm
- Extremely powerful tools
- Easy to use
- Output designed with hole for pinning as well as a nut-driver holder ring
- Lightweight and handy tool for attaining the highest torque values in commercial vehicle and industrial applications
- One-hand reversing switch

- Operation optimised on both sides for left and right handed users
- Optimised feel
- Air connection possible on the handle at the bottom and rear
- Exhaust air is guided downwards through the handle
- Reduced vibrations
- Coupler plug: nominal size 10 mm (included)
- Forward / Reverse: 3-stage



Direct hammer striking mechanism: less vibrations and higher output



9014 P-1

### 9014 PS-1

25 1" **NEW!**

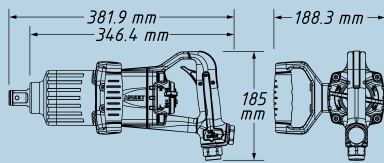

### 9014 P-1

25 1"

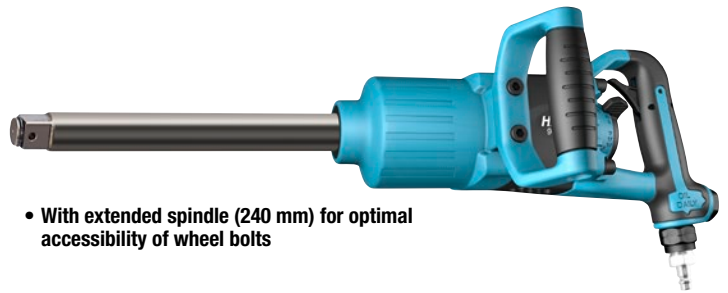

- With extended spindle (240 mm) for optimal accessibility of wheel bolts

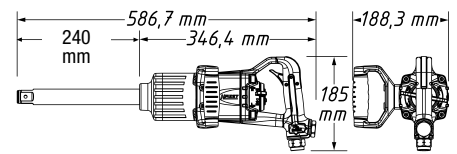

HAZET No.	EAN-No. 4000896+	■	max. Nm	max. Nm	Bar	rpm	l/min	dB(A) Lp A	m/s <sup>2</sup>	Ø mm	kg	✓	20.67 10	✓
9014 PS-1	222490	25 1"	3.400	2.400	6.3	5.500	283	103.5	15.94	19	7.8	✓	20.67 10	✓
9014 P-1	218332	25 1"	3.400	2.712	6.3	5.500	283	103.5	15.94	19	8.5	✓	20.67 10	✓

## Mini air ratchet

- Working pressure: 6.3 bar
- For hand retightening with torque values 60 – 400 Nm
- Completely closed head prevents the entry of swarf etc.

### 9020 P-2 6.3 1/4"

- Max. loosening torque: 40 Nm

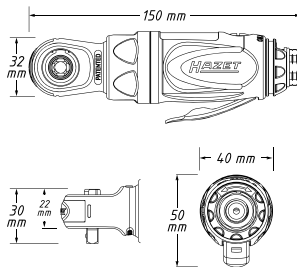

### 9021 P-2 10 3/8"

- Max. loosening torque: 54 Nm

### 9022 P-2 12.5 1/2"

- Max. loosening torque: 108 Nm

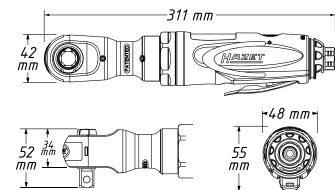

HAZET No.	EAN-No. 4000896+	■	max. Nm	rpm	l/min	dB(A) Lp A	m/s <sup>2</sup>	kg	✓	12.91 7.2
9020 P-2	184323	6.3 1/4"	40	250	72	90	12.24	0.5	✓	12.91 7.2
9021 P-2	184545	10 3/8"	54	300	103	92	10.23	0.5	✓	12.91 7.2
9022 P-2	184538	12.5 1/2"	108	280	113	99	7.47	1.24	✓	12.91 7.2





Das Werkzeug

# Pneumatic Tools



**NEW!**

## 9021 SR-1 10 3/8

EAN-No. 4000896218295

### Impact ratchet

- Max. occupational safety thanks to reaction-free behaviour (striking mechanism)
- Rubber ratchet head protective cover to protect against shocks and penetration by dirt
- Use in constricted spaces
- Pneumatic impact ratchet for loosening and tightening screw connections in areas with restricted access
- Coupler plug: nominal size 7.2 (included)
- Forward/reverse: single-stage (right / left)

**For hand retightening with torque values: 260 Nm**



YouTube clip



■	↻	rpm	⚙️	🔊	⚖️	🔧	🔌	🔩
max. Nm	upm	Bar	l/min	∅ mm	kg	✓	12,91(l) 7,2	✓
10 3/8	68	500	6.3	68	10	0.67	✓	12,91(l) 7,2

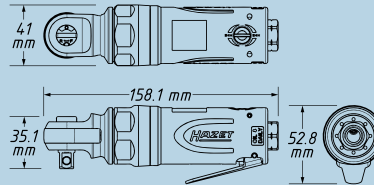

## 9022 SR-1 125 1/2

EAN-No. 4000896170593

### Impact ratchet

- Max. loosening torque: 102 Nm
- For hand retightening with torque values > 270 Nm
- Non-rebound



■	↻	rpm	⚙️	🔊	⚖️	🔧	🔌	🔩
max. Nm	upm	l/min	dB(A) Lp A	m/s <sup>2</sup>	kg	✓	12,91(l) 7,2	✓
125 1/2	102	400	113	91	4.53	1.99	✓	12,91(l) 7,2

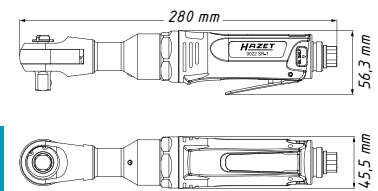

## 9022-360 125 1/2

EAN-No. 4000896209781

### High performance air ratchet

- 360° rotatable operating lever
- Switching between left and right via the adjusting ring on the handle
- Extremely powerful item for applications in areas with very restricted access

#### Quiet Mode

30% less noise thanks to the ability to reduce operating noise / Quiet Mode

Quiet Mode		Normal Mode	
dB(A) Lp A	max. Nm	dB(A) Lp A	max. Nm
81.5	95	91.2	120

rpm	⚙️	🔊	⚖️	🔧	🔌	🔩
upm	bar	m/s <sup>2</sup>	l/min.	kg	✓	12,91(l) 7,2
200	6.3	4.87	107.6	1.55	✓	12,91(l) 7,2

**For hand retightening with torque values: 500 Nm (Comparable: approx. 250 Nm)**



360° rotatable trigger lever

YouTube clip

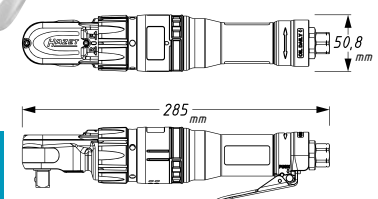





# Pneumatic Tools

9033-11/17, EAN-No. 4000896222575

## Bristle grinder set

- For gentle yet effective cleaning of surfaces
- For using with various grinding media to remove rust, paint, adhesive and sealing residues or to clean metal surfaces and weld seams
- Thread grinding disc 1/4"-20 UNC
- Dimensions: 112.1 x 152 x 45 mm
- Roloc™ quick-change system allows the plastic brush to be changed quickly and easily without any extra tool



17 **NEW!**



Ø mm	m/s	rpm	Bar	l/min	HP	Watt	Ø mm	Lp A	Lp W	kg	✓	12.91 (in)
50	3.11	15000	6.3	79	0.3	224	10	75	86	0.54	✓	12.91 (in)

### Spare parts

HAZET No.	Designation	Design	Quantity	EAN-No. 4000896 +
9033-11-015	Plate bristle grinder	Ø 50 mm	1	222841
9033-11-020/4	Strip wheel set	Hard variant	4	222834
9033-11-030/4	Strip wheel set	Soft variant	4	222728
9033-11-036/2	Spare bristle grinder set, purple	Grain size: 36	2	222872
9033-11-050/2	Spare bristle grinder set, green	Grain size: 50	2	222865
9033-11-0120/2	Spare bristle grinder set, white	Grain size: 120	2	222858

9034 P-2, EAN-No. 4000896218288

## Sabre saw

- Increased efficiency with reduction of weight, air consumption, noise generation and vibration
- Direction of air exhaust adjustable
- Saw stroke: 10 mm
- Stroke/Min.: 9500
- Stroke length: 10 mm
- Cutting capacity in sheet steel: 3 mm, aluminium: 4 mm

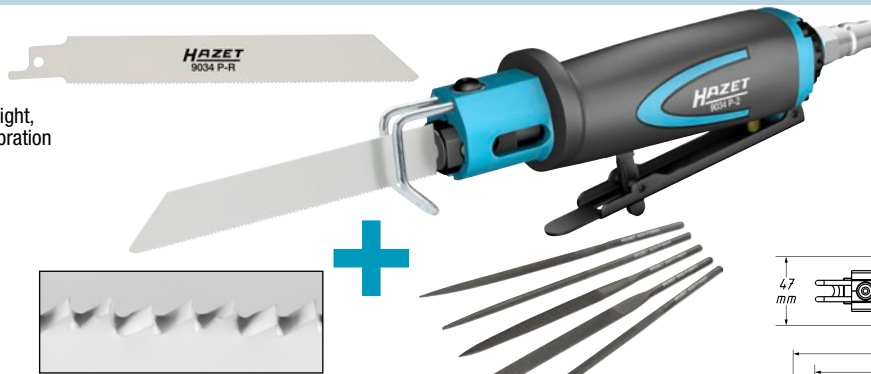

HAZET No.	l/min	dB(A)	m/s <sup>2</sup>	Ø mm	kg
9034 P-2	99	86.7	6.13	10	0.4

18	HAZET 9034-018
24	HAZET 9034-024
32	HAZET 9034-032

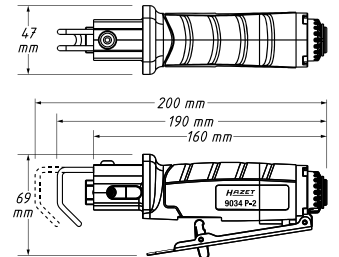

### Accessories

9034 P-R/5, EAN-No. 4000896218318

## Reciprocal saw blades

- Bevelled, corrugated teeth
- Length: 135 mm

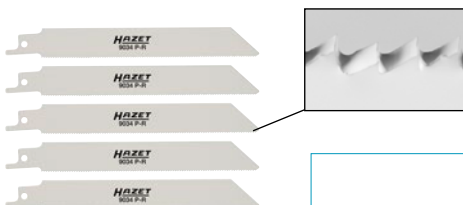

5 9034 P-050/5, EAN-No. 4000896218349

## File set

- Especially suited for removing burr and dirt on e.g. bearing seats, Anti-Lock Braking System (ABS) sensor receptacles
- Length: 135 mm

- Contents:**  
 1 round file  
 1 triangular file  
 1 half-round file  
 1 flat file  
 1 square file

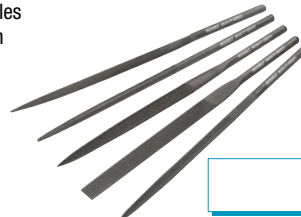

5 Saw blades

HAZET No.	EAN-No. 4000896 +
9034-018/5	139392
9034-024/5	139408
9034-032/5	139415



Das Werkzeug

# Pneumatic Tools



**NEW!**

## Carbide milling pin set

- Long service life and good cutting performance when used on diverse materials
- Universal use in metalworking on almost all materials
- For deburring, rounding, levelling or machining contours
- Suitable for hand-guided or stationary drive machines
- According to DIN 8032

### HAZET application tip:

- Use as high speeds as possible
- Contact surface between milling pin and workpiece should never exceed 30 % of the complete milling circumference

YouTube clip



### 9032-03/5

EAN-No. 4000896222483

#### 3 mm

- Milling pin with 3 mm shaft
- Set with 5 different milling cutters in cylindrical, tapered and spherical shape
- Head diameter (cylindrical shape): 3 / 6 mm
- Working length: approx. 13 mm
- Head diameter (spherical shape): approx. 3 / 6 mm

Made in Germany



### 9032-06/3

EAN-No. 4000896222667

#### 6 mm

- Milling pin with 6 mm shaft
- Set with 3 different milling cutters in cylindrical, tapered and spherical shape
- Head diameter (cylindrical shape): 10 mm
- Working length: approx. 19 mm
- Head diameter (spherical shape): approx. 9 mm

Made in Germany



## 9032 M

EAN-No. 4000896195152

### Micro die grinder

- Power: 190 Watts
- 3 mm collet chuck

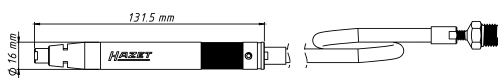

## 9032 M-36

EAN-No. 4000896209606

### Mini die grinder

- Power: 224 Watts
- 6 mm collet chuck with 3 mm adapter to accommodate both grinding pad dimensions

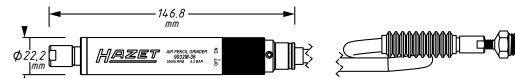

mm	upm	kg	l/min.	dB(A)	m/s <sup>2</sup>	mm	12.91(+)	7.2
3	60.000	0.21	75	LpA 83	0.13	1500		

mm	upm	kg	l/min.	dB(A)	m/s <sup>2</sup>	mm	12.91(+)	7.2
3 / 6	30.000	0.38	43.7	Lp A 78.7	1.80	1500		

## Die grinder

- For sanding, polishing, burnishing, deburring



HAZET No.	Design	Power Watt	mm	rpm	l/min	dB(A) Lp A	m/s <sup>2</sup>	kg		12.91(+)	7.2	EAN-No. 4000896 +
9032 N-5	Angled	224	6	2,000 – 20,000	74	79	0.4	0.5	✓	12.91(+)	7.2	198788
9032 N-1	Straight	224	6	25,000	74	79	0.4	0.4	✓	12.91(+)	7.2	189359
9032 LG-1	Straight, long	360	6	22,000	99	81	0.5	0.6	✓	12.91(+)	7.2	209675







# Pneumatic Tools

## 9033 N-4

EAN-No. 4000896210183

### Belt sander

- Including three abrasive belts 330 x 10 mm (grain size 80, 100, 120)
- For narrow surfaces (belt width 10 mm)
- Locking device for quick belt changing
- Continuous speed regulation via speed regulator on back of handle

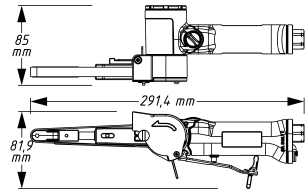

Abrasive belts:



Automatic belt adjustment

upm	kg	l/min.	dB(A)	m/s <sup>2</sup>	✓	12,91(+)
19.000	0.8	94	LpA 83.8	1.88		7/2

## 9033 N-7

EAN-No. 4000896205547

### Right-angle grinder

- For areas with difficult access
- Lateral handle, to be used on left or right side
- Quick adjustment (without tools) of protection cover
- For grinding discs 0.8–6 mm thick
- Spindle thread: M14 x 2

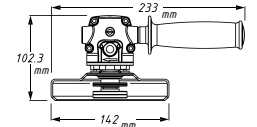

upm	kg	l/min.	dB(A)	✓	12,91(+)
12000	2	113	LP A 85		7/2

## 9033 P-8

EAN-No. 4000896190515

### Angle grinder

Suitable for cutting metal sheet and steel

- Quick adjustment (without tools) of protection cover
- Pressure key for locking the output enables easy changing of cut-off wheels

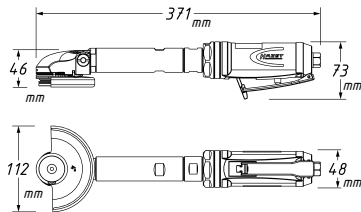

Low installation height

YouTube clip



mm	upm	kg	l/min.	dB(A)	m/s <sup>2</sup>	mm	✓	12,91(+)
10	14000	1.7	113	LP A 89,5	3.65	100 x 0.8 x 9,53		7/2

## 9033-10

EAN-No. 4000896196371

### Angle grinder

For processing of workpieces even in areas with very restricted access

- Power: 522 Watts
- Including 1 cut-off wheel

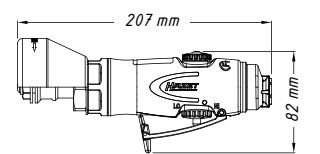

Forward/reverse for controlling flying sparks

Continuous speed regulation



mm	upm	kg	l/min.	dB(A)	m/s <sup>2</sup>	mm	✓	12,91(+)
10	18000	0.9	114	LP A 88	1.8	76 x 2.1 x 10.0		7/2

## Spare parts

### Abrasive belt set

Suitable for belt sander 9033 N-4

10



9033-480/10 Grain size 80



9033-4100/10 Grain size 100



9033-4120/10 Grain size 120

HAZET No.	EAN-No. 4000896 +	
9033-480/10	139101	
9033-4100/10	139118	
9033-4120/10	139125	

### Cut-off wheel set / Grinding wheel set

Suitable for right-angle grinders 9033 N-7

5

10

25

Cut-off wheel sets

9233-010/5



Grinding wheel set

9233-011/10



9233-010/25



125 x 1.0 x 22.23 mm

125 x 6.0 x 22.23 mm

HAZET No.	EAN-No. 4000896 +	
9233-010/5	219063	
9233-011/10	219087	
9233-010/25	219070	

### Cut-off wheel set

Suitable for angle grinder 9033 P-8

5

25



9033-P-08/5

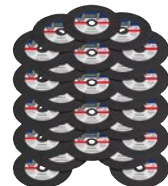

9033-P-08/25

Made in Germany

HAZET No.	EAN-No. 4000896 +	
9033-P-08/5	201549	
9033-P-08/25	201402	

### Cut-off wheel set

Suitable for angle grinder 9033-10

5



Made in Germany

HAZET No.	EAN-No. 4000896 +	
9033-010/5	199969	



Das Werkzeug

# Pneumatic Tools



## 9043 N-10

EAN-No. 4000896198382

### Switchable air blow and suction gun

For sucking up dirt into the dust collection bag as well as for blowing surfaces clean

- With speedy one-hand switching of the function direction

YouTube clip

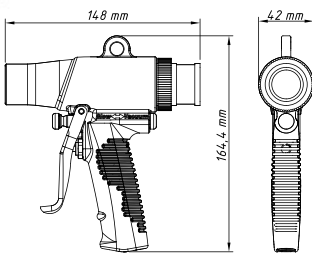
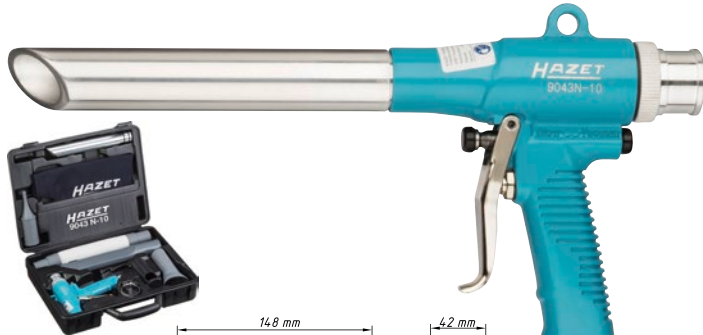

Vacuum level	kg	l/min.	bar	dB(A)	dB(A)	m/s <sup>2</sup>	12,91(+)
7.5	0.4	96	6.3 - 10.34	Lp A 92	Lp W 97	0.4	9000-010

## 9043 N-10-08/2

EAN-No. 4000896222827

### Fine dust bag

- Particularly suitable for sucking up fine dust
- For use with air blow and suction gun 9043 N-10

**NEW!**



## 9035-5

EAN-No. 4000896132355

### Needle scaler

- Adjustable needle cover

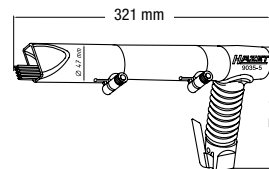
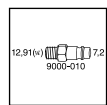

19 needles, Ø 3 mm

Impacts	kg	l/min.	dB(A)	m/s <sup>2</sup>
3200	2.6	170	Lp A 97	8.7



## 9035-050

EAN-No. 4000896139385

- Spare needles for 9035-5
- 19 needles, Ø 3 mm



## 9035 V/5

EAN-No. 4000896213368

### Vibration chisel set

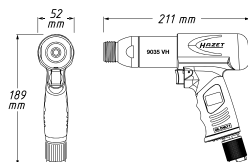
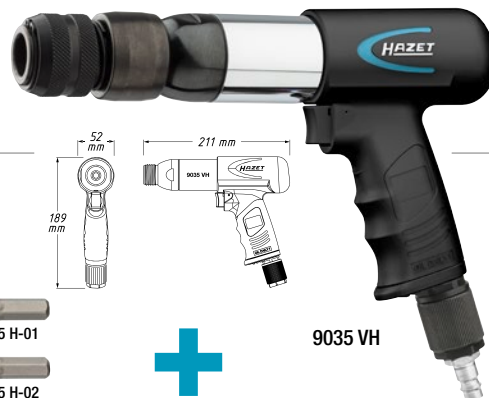
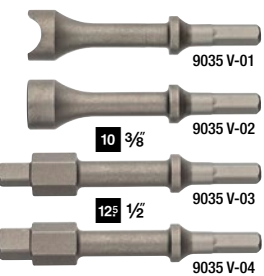

## 9035 H/6

EAN-No. 4000896214655

### Chisel hammer set



bar	l/min.	dB(A) Lp A	kg
6.3	57 - 594	92 - 105	2.5

## 5 Components



HAZET No.	Designation	EAN-No. 4000896+
<b>Adapter</b>		
9035 VH-01	Quick-clamp adapter	214242
<b>Spare parts</b>		
9035 V-01	Semi-circular vibration chisel	214181
9035 V-02	Circular vibration chisel	214174
9035 V-03	3/8" Vibration chisel	214167
9035 V-04	1/2" Vibration chisel	214150
<b>Spare parts as set</b>		
9035 V/4	Set, 4 pieces	214013
<b>Basic unit, individual</b>		
9035 VH	In case including keyless drill chuck	214020

## 6 Components

HAZET No.	Designation	EAN-No. 4000896+
<b>Adapter</b>		
9035 VH-01	Quick-clamp adapter	214242
<b>Spare parts</b>		
9035 H-01	Flat chisel	214136
9035 H-02	Sheet metal cutting chisel	213924
9035 H-03	Pointed chisel	214198
9035 H-04	Rivet cutting chisel	214143
9035 H-05	Curve cutting chisel	214525
<b>Spare parts as set</b>		
9035 H/5	Set, 5 pieces	214006
<b>Basic unit, individual</b>		
9035 VH	In case including keyless drill chuck	214020







**NEW!**

## 9043 N-1

EAN-No. 4000896221783

### Cyclonic cleaning gun

- For perfectly cleaning e.g. upholstered areas, foot mats, animal hair as well as vehicle preparation, rim and part cleaning with suitable cleaning media
- The working pressure can be set to the cleaning medium for processing or the specific application via the setting wheel on the handle (read processing notes of cleaning manufacturer)
- Includes brush attachment
- Handle, trigger and valve made of acetal plastic
- Air inlet inside thread (IG) (1/4")
- Coupler plug: nominal size 7.2 (included)
- Hose diameter (recommended): 10 mm
- Optional suction attachment (for use as wet suction cup) HAZET 9043N-2 available



YouTube clip



Not for sale in the USA

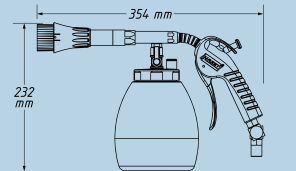

Bar	l/min	dB(A) Lp A	dB(A) Lp W	m/s <sup>2</sup>	mm	kg
4 - 6.3	254	88.3	89.4	1.44	354	0.76

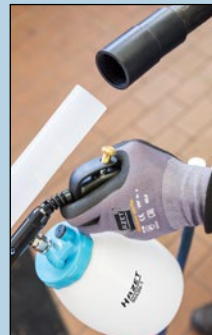
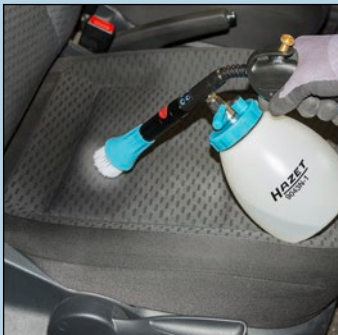

## 9043 N-2

EAN-No. 4000896222506

### Suction attachment for cyclonic cleaning gun

- **Optional suction attachment for cyclonic cleaning gun HAZET 9043N-1**
- For use on the cyclonic cleaning gun as a wet suction cup for sucking up applied cleaning medium as well as detached impurities in one work step. Suction attachment prevents cleaning medium from penetrating deep inside and maximises the cleaning effect of the basic unit
- Includes 4-piece adapter set for connecting to numerous wet suction devices
- Made from fully transparent plastic
- Allows you to check the cleaning results during operation
- Fixing the suction attachment via a knurled screw
- Width of orifice: 69 mm

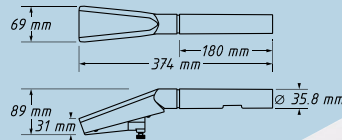

**NEW!**

5

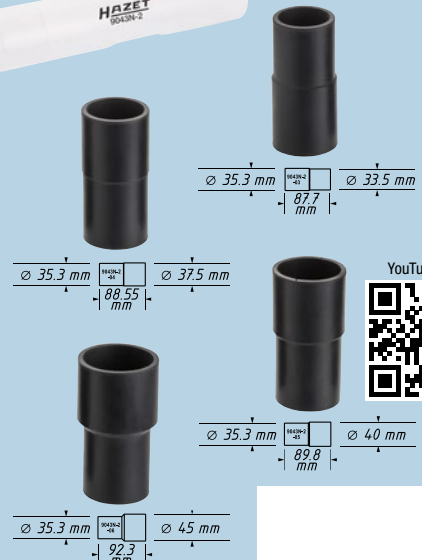

YouTube clip



mm	kg
374	0.45

Not for sale in the USA



## 9040-4

EAN-No. 4000896176236

### 2-way air blow gun

- Choice of air supply at tool head or handle
- Pressure regulator
- Exchangeable nozzles (steel)
- Short nozzle for areas with restricted access
- Aluminium housing



With 112 mm nozzle

**Top seller!**

## 9040 P-1

EAN-No. 4000896209545

### Air blow gun 100 mm

- With bent pipe  $\varnothing$  8 mm
- For the fast removal of shavings or other foreign objects, especially in areas that are difficult to access
- To be used on machinery, in workshops, for wood work and in the home
- Application field:  $-10^{\circ}\text{C}$  to  $+80^{\circ}\text{C}$
- Blast pipe and shaft made of anodised steel



**Standard nozzle**

## 9040 P-2

EAN-No. 4000896209552

### Air blow gun 300 mm

- With straight tube  $\varnothing$  8 mm
- For the fast removal of shavings or other foreign objects, especially in areas that are difficult to access
- To be used on machinery, in workshops, for wood work and in the home
- Application field:  $-10^{\circ}\text{C}$  to  $+80^{\circ}\text{C}$
- Blast pipe and shaft made of anodised steel



**Long nozzle**

## 9040 P-3

EAN-No. 4000896209644

### Air blow gun 100 mm, quiet with bent pipe

- With bent pipe  $\varnothing$  8 mm
- Extreme reduction of noise
- Non-blocking
- Blast pipe and shaft made of anodised steel



**Quiet nozzle**

## 9040 P-4

EAN-No. 4000896209569

### Air blow gun 100 mm, with Venturi nozzle and bent pipe

- With bent pipe  $\varnothing$  8 mm
- 100% increase in air outlet quantity thanks to Venturi nozzle
- Extreme blowing force
- Non-blocking
- Max. working pressure: 16 bar



**Venturi nozzle**

## 9040 P-5

EAN-No. 4000896209576

### Air blow gun, quiet with wide flat nozzle

- With wide flat nozzle for cleaning surfaces
- Considerable blowing force
- Non-blocking



**Wide nozzle**

## 9040 Lg-3/2

EAN-No. 4000896206339

### Air blow gun, long design

- With 90° Venturi nozzle ① and side nozzle ②
- Cold insulated handle on the lance
- For cleaning areas with restricted access on vehicles, machinery and agricultural machinery
- Especially suitable for cleaning cooling fins

**Long design for industry and commercial vehicles!**

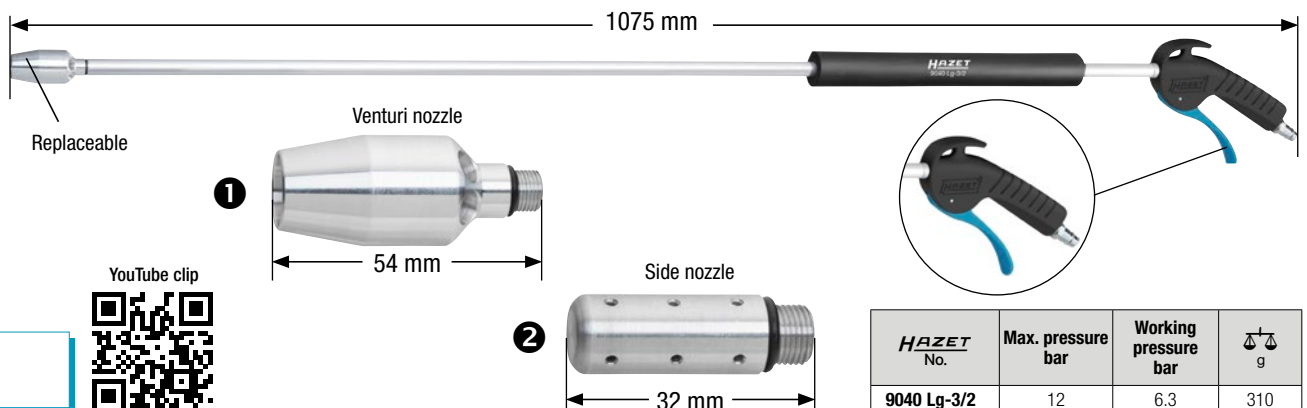

HAZET No.	Max. pressure bar	Working pressure bar	⚖️ 9
9040 Lg-3/2	12	6.3	310





## Pneumatic Tools

### 9048 P-1

EAN-No. 4000896209583

#### Cooling system cleaner

- Cooling system cleaning without the use of aggressive chemicals and solvents
- Fast and efficient cleaning of the cooling system as well as restoring its performance capability
- The combined use of water and compressed air creates top cleaning performance
- Including 1/2" connecting nipple for water couplings
- 5-step nozzle
- Water requirement: 6 l/min

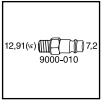
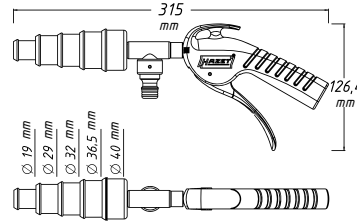

YouTube clip



HAZET No.	bar	(6 bar) l/min.	kg
9048 P-1	6-10	230	0.280

### 9042 P-4

EAN-No. 4000896209613

#### Car body gun for underbody protection and cavity sealing

- Including metal suction pipe
- Suitable for aqueous and oily liquids
- Including nozzle and cavity tube
- Application field: -10°C to +80°C
- Air requirement with cavity tube: 180 l/min at 8 bar
- Nozzles made of steel / plastic

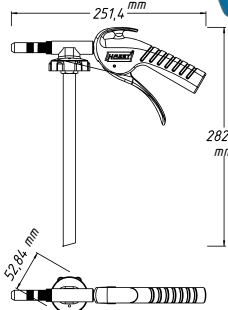
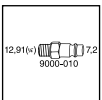
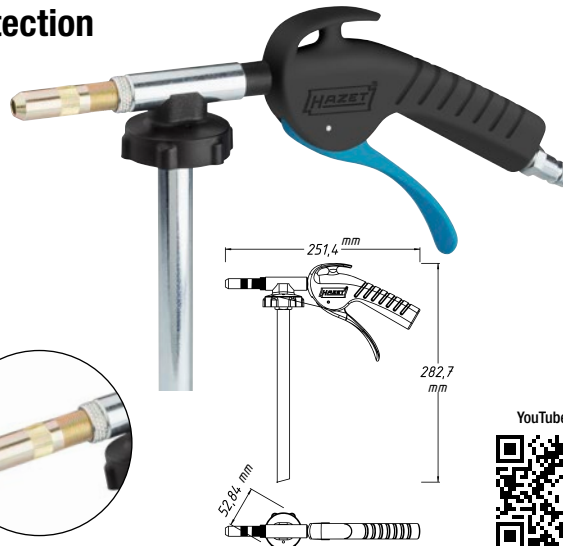

YouTube clip



HAZET No.	max bar	(6 bar) l/min.	kg
9042 P-4	16	255	0.422

### 9045 P-1

EAN-No. 4000896209590

#### Soda spray gun

- Mineral spray gun for damage-free cleaning and removal of paint
- No heating / deformation of sheets during blasting
- Removes paint from wooden objects without any damage
- Removes paint from glass surfaces and window frames without causing damage to glass and seals
- For the gentle removal of graffiti as well as for cleaning facades and monuments
- With preset precision nozzle for optimal performance
- Including refillable container with 1,2 l volume
- Environmentally friendly
- For blasting with NaHCO<sub>3</sub> (sodium bicarbonate)
- Including metal nozzle and 3 wide spray nozzles

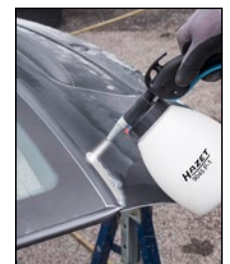
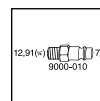

Including 1 kg of soda blast-cleaning agent

YouTube clip

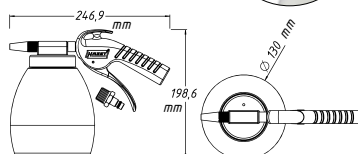

HAZET No.	bar	(6 bar) l/min.	kg
9045 P-1	6-12	280	0.460

### 9045 P-5S

EAN-No. 4000896210404

#### Soda blast-cleaning agent

- 5 kg





Das Werkzeug

# Pneumatic Tools



## Compressed air hoses with quick coupling and connecting nipple

- Including pressed fittings coupling/nipple
- For workshop, industry and hobby
- PVC compressed air hose
- Corresponding to DIN EN ISO 5774:2008 "Hydrostatic requirements" (Type C)
- Working pressure: up to 15 bar
- Burst pressure: 45 bar

Made in Germany

HAZET No.	Ø mm	l m	EAN-No. 4000896+
9040-610	6	10	221929
9040-620	6	20	221912
9040-1010*	10	10	221899
9040-1020	10	20	221905

\* Recommended by HAZET for commercial application Ø 10 mm



**NEW!**

## Hose reel

- Suitable for compressed air or water
- Black hybrid polymer hose
- Neat winding of the hose thanks to automatic guidance

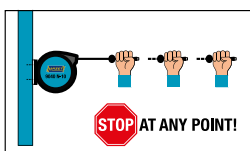
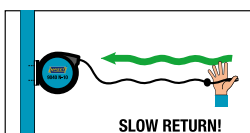

YouTube clip



**9040 N-13: Meets all relevant requirements defined in European Machinery Directive 2006/42/EC**

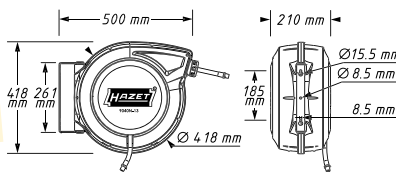

HAZET No.	°C	Outside thread	Hose inside Ø mm	bar	kg	EAN-No. 4000896+
9040 N-10	-40°/+60°	16.41 mm 3/8"	10	20	7.75	206445
9040 N-13	-40°/+80°	20.96 mm 1/2"	13	20	9.5	214648

## Cable reel

- Including line circuit breaker
- Only suitable for indoor use

YouTube clip



**230V AC Cable: H07RN-F 3x 2.5 mm<sup>2</sup>**

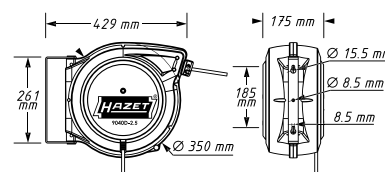

HAZET No.	°C	Watt	Watt	kg	EAN-No. 4000896+
9040 D-2.5	-20/+45°	1,600	3,200	9.2	214631

## Spiral hose

- High flexible polyurethane hose
- Connecting pieces with 360° rotary joints

HAZET No.	l m	Burst pressure according to DIN	Hose inside Ø mm	bar	EAN-No. 4000896+
9040-7	7.62	55.1 bar/800 PSI	6.35	10	153404
9040 S-10*	7.62	60 bar	10	10	212361

\* Recommended by HAZET for commercial application Ø 10 mm







# Pneumatic Tools

## 9037 N-2

EAN-No. 4000896205578

### Blind rivet gun

- Professional riveting, suitable for continuous operation with rivets of up to 6.4 mm made of steel, stainless steel, aluminium and copper
- Possible rivet sizes: 3.0 - 3.2 - 4.0 - 4.8 - 5.0 - 6.0 and 6.4 mm
- 5 nose pieces
- Flexible connecting nipple
- Total stroke: 15.8 mm
- High tractive power: 14700 N
- Particularly quiet
- Includes maintenance set for oil control (oil-supported pressure build-up)



HAZET No.	kg	l/min.	l mm			EAN-No. 4000896 +
9037 N-2	2.11	2.64	296.6	✓	12,91(+) 7,2	205578

## 9042 N-1

EAN-No 4000896176472

### Grease gun

- Continuous pumping of grease
- Gun-filling with grease cartridge, loose grease or via dispenser
- Compaction: 40:1
- 360° adjustable handle

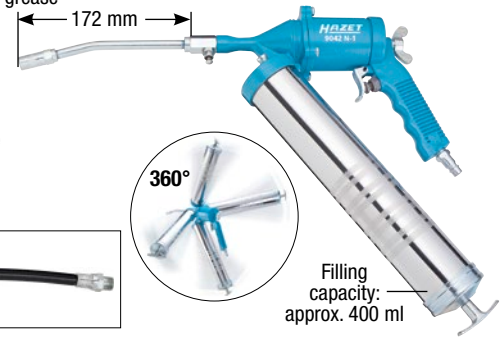

HAZET No.	kg	l/min.	mm Nylon hose	mm Metal tube		EAN-No. 4000896 +
9042 N-1	2	230	230	172	12,91(+) 7,2	176472

## 9000-080

EAN-No. 4000896214709

### Compressed air reducer

- Reduction of working pressure to protect high-quality pneumatic equipment
- Inline pressure regulator for integration in the compressed air line or direct connection to motorised pneumatic equipment
- **Max. inlet pressure: 10 bar**
- Outlet pressure: 6.3 bar
- Weight including air connection nipple: 140 g
- Including:
  - Adapter from outside thread (AG) (1/4") to outside thread (AG) (1/4") for connecting to the device
  - Air connection nipple 7.2 Type 1 for connection to compressed air coupling



## Safety coupling 1/4" / 3/8" / 1/2"

- Safe disconnection of the connection (unwanted disconnection is excluded)
- No risk of injury from hose impact
- Safety coupling depressurizes the connection before decoupling
- One-hand operation
- Little effort during coupling and decoupling
- Omission of loud popping during coupling process
- Easy operation, even with gloves
- 9000-050 up to 9000-070 brass, nickel-plated

9000-050, EAN-No. 4000896195275

### Safety coupling 1/4" outside thread (AG)



9000-060, EAN-No. EAN 4000896195312

### Safety coupling 1/4" inside thread (IG)



9000-070, EAN 4000896195305

### Safety coupling with 10 mm hose nipple



9000-051, EAN 4000896195282

### Safety coupling 3/8" outside thread (AG)



9000-061, EAN 4000896195299

### Safety coupling 3/8" inside thread (IG)



9000-062, EAN 4000896218936

### Safety coupling 1/2" inside thread (IG)

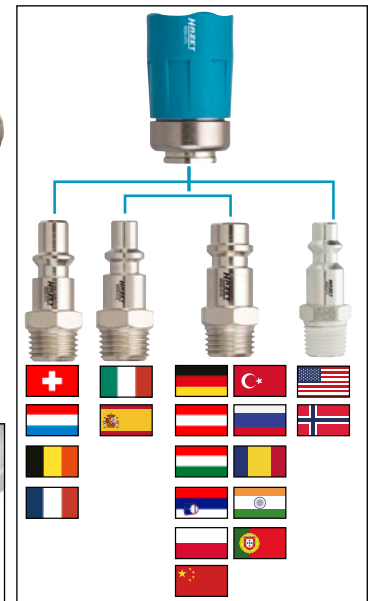
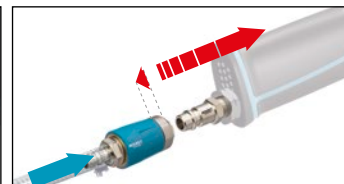
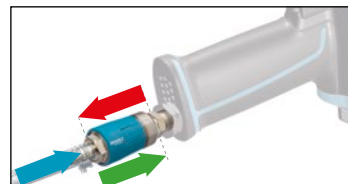
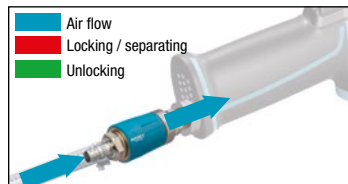

Not recommended for 3/4" and 1" devices or those with strong vibrations (applies for all safety couplings shown here apart from 9000-062)  
You can find rotary joints and air connection nipples/hose nipples in the tool catalogue 2019 from page 338



Das Werkzeug

# Pneumatic Tools



**NEW!**

## 1990-10

EAN-No. 4000896218271

### Hot-air tool

- Basic design - excellent price-quality ratio
- Power: 1600 Watts
- 2 air volume ranges: 350 / 500 l/min (two-stage switch)
- High-quality ceramic heater, optimal device cooling and powerful motor ensure a long service life
- Sucked in air is blown through the motor, this preventing dirt from contaminating the motor
- Optimal, well balanced ergonomics
- Can be placed upright (readiness storage)
- Including heating element protection
- Net weight (kg): 0.68 kg
- Temperature range: 350 °C – 500 °C (two-stage switch)
- Electronics: Flicker-conformant
- Supplied in carton

*For soft soldering, paint removal, welding, shrink wrapping, forming and much more ...*

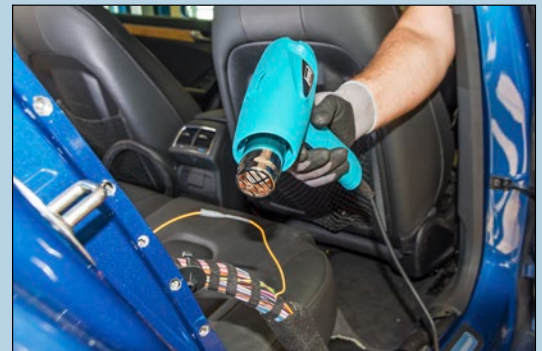

## 2162 M

EAN-No 4000896185634

### Mini grease gun

- Creates pressure up to 1,000 PSI / 69 bar
- Suitable for filling with loose grease
- Incl. lubricating nipple in 50° and 90° designs

HAZET recommends greasing pneumatic devices 1x p.a.



280 g

## 9070 N-1

EAN-No 4000896206407

### Mini oiler

- Supports longevity and permanent functionality
- Reduces wear of the air motor



Outside thread  
12,91 (1/4")



12,91 (1/4")  
Inside thread

HAZET No.	Description	EAN-No. 4000896 +
9300 N-60	High performance grease 60 ml. Especially suited for use with mini grease gun 2162 M	203406

Description	l mm
Mini oiler, refillable quantity: 28 ml	54







# Pneumatic Tools



**1 rechargeable battery for all devices!**

**9212 SPC-1**, EAN-No. 4000896212439

## Cordless impact wrench 18 V

- Max. loosening torque: 260 Nm
- Max. tightening torque: 200 Nm
- Extremely handy tool
- Amperage without load: 5 A
- Charging time ~ 35 min
- **Contents:**  
 Cordless impact wrench, quick charger, Li-ion rechargeable battery 2.0 Ah (1x), high-quality carrying case

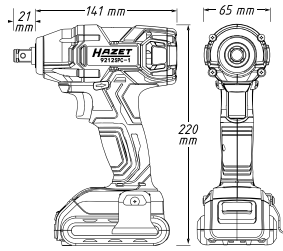

	kg		kg
With rechargeable battery	1.45	Without rechargeable battery	1.06



12.5 1/2 3

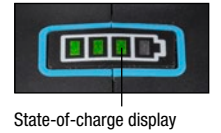

HAZET No.	Designation	EAN-No.	
9212 SPC-1/4	Cordless impact wrench 18 V with 2 rechargeable batteries	214259	
9212 SPC-010	Basic unit	214273	



Incl.



12.5 1/2 3



**9212 M-1**, EAN-No. 4000896212446

## Mini cordless impact wrench 18 V

- Max. loosening torque: 270 Nm
- Max. tightening torque: 220 Nm
- Extremely handy and short tool
- High efficiency thanks to brushless motor
- Three selectable performance levels for torque screw tightening  
 Level 1: approx. 80 Nm at 700 rpm  
 Level 2: approx. 150 Nm at 1600 rpm  
 Level 3: approx. 220 Nm at 2500 rpm
- Amperage without load: 4,5 A
- Charging time ~ 35 min
- **Contents:**  
 Cordless impact wrench, quick charger, Li-ion rechargeable battery 2.0 Ah (1x), high-quality carrying case

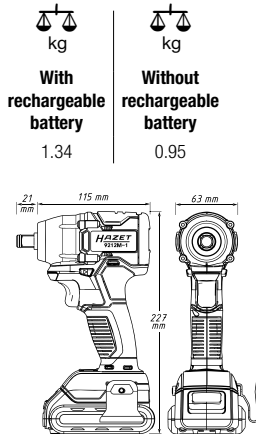

	kg		kg
With rechargeable battery	1.34	Without rechargeable battery	0.95



State-of-charge display

HAZET No.	Designation	EAN-No.	
9212 M-1/4	Mini cordless impact wrench with 2 rechargeable batteries	214266	
9212 M-010	Basic unit	214280	

**Brushless DC motor (BLDC)**

- Longer service life, less wear, no need to change the carbon brushes
- High efficiency and hence less battery consumption
- More compact motor enables smaller dimensions

**9212-3**, EAN-No. 4000896203444

## Cordless impact wrench 18 V

- Max. loosening torque: 700 Nm
- Max. tightening torque: 500 Nm
- High efficiency thanks to brushless motor
- 18 V, 5.0 Ah, Li-ion rechargeable battery
- Three selectable performance levels for torque screw tightening
- Hand strap included
- Level 1: approx. 80 Nm at 600 rpm, Level 2: approx. 300 Nm at 1400 rpm, Level 3: approx. 500 Nm at 2000 rpm
- Amperage without load: 5,5 A
- Replacement battery: 9212-05
- Charging time 75 min.
- **Contents:**  
 Cordless impact wrench, quick charger, Li ion rechargeable battery (1x), case

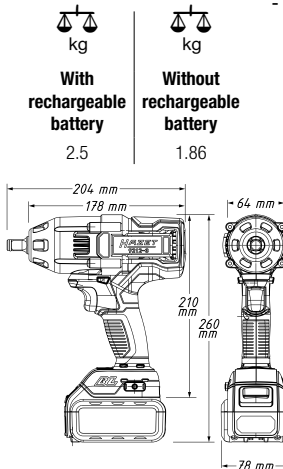

	kg		kg
With rechargeable battery	2.5	Without rechargeable battery	1.86



12.5 1/2 3

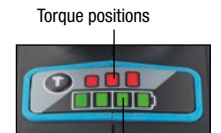

State-of-charge display

### Replacement battery suitable for all cordless impact wrenches

HAZET No.	Designation	EAN-No.	
9212-02	Replacement battery 2.0 Ah	213788	
9212-05	Replacement battery 5.0 Ah	210367	





Das Werkzeug

# Pneumatic Tools



**1 rechargeable battery for all devices!**

## Cordless impact wrench 18 V, 5 Ah

- Max. loosening torque: 1400 Nm
- Max. tightening torque: 1000 Nm
- High efficiency thanks to brushless motor
- Three selectable performance levels for torque screw tightening:
  - Level 1: approx. 180 Nm at 0 – 400 rpm
  - Level 2: approx. 400 Nm at 0 – 800 rpm
  - Level 3: approx. 1,000 Nm at 0 – 1,800 rpm
- Forward/reverse: multistage (left/right)
- With illumination of the work area before the output begins to move
- Robust machine housing
- Suitable for continuous operation
- Li-Ion battery with significantly lower self-discharge (only 2%) compared to a standard NiMH rechargeable battery (15-25%)
- Charging time at 5.0 Ah battery: approx. 80 min
- Brushless DC motor (BLDC)
  - Longer service life, less wear, no need to change the carbon brushes
  - High efficiency and hence less battery consumption
  - More compact motor enables smaller dimensions
- Revolutions per minute left/right: 0 – 400 / 0 – 800 / 0 – 1800 rpm
- Screw size: M24
- Including belt clip, attachable on both sides
- In plastic box

12.5 1/2"

20 3/4"

**NEW!**

YouTube clip



12.5 1/2"

**9212-1000**

kg  
With rechargeable battery  
3.64

kg  
Without rechargeable battery  
3.00

20 3/4"

**9213-1000**

kg  
With rechargeable battery  
3.70

kg  
Without rechargeable battery  
3.04

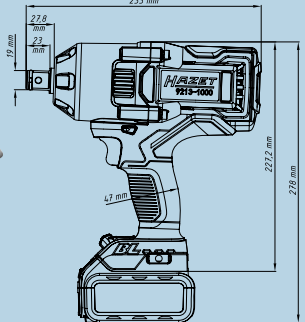

max. Nm	max. Nm	max. Nm	dB(A) Lp A	dB(A) Lp W	m/s <sup>2</sup>
1,400	1,000	1,000	101	112	17.8



20 3/4"

**9213-1000/3**

12.5 1/2"

**9212-1000/3**



20 3/4"

**9213-1000/4**

12.5 1/2"

**9212-1000/4**

HAZET No.	■	Designation	■	EAN-No. 4000896 +
9212-1000	12.5 1/2"	Cordless impact wrench basic unit	1	222711
9212-1000/3	12.5 1/2"	3-piece set, contents: 1 basic unit, 1 quick charger, 1 Li-ion rechargeable battery 5Ah, plastic box	3	222674
9212-1000/4	12.5 1/2"	4-piece set, contents: 1 basic unit, 1 quick charger, 2 Li-ion rechargeable batteries 5Ah, plastic box	4	222681
9213-1000	20 3/4"	Cordless impact wrench basic unit	1	222698
9213-1000/3	20 3/4"	3-piece set, contents: 1 basic unit, 1 quick charger, 1 Li-ion rechargeable battery 5Ah, plastic box	3	222704
9213-1000/4	20 3/4"	4-piece set, contents: 1 basic unit, 1 quick charger, 2 Li-ion rechargeable batteries 5Ah, plastic box	4	222797

## Spare battery

HAZET No.	Designation	EAN-No. 4000896 +
9212-02	Replacement battery 2.0 Ah	213788
9212-05	Replacement battery 5.0 Ah	210367
9212-03	Quick charger for rechargeable batteries	204823

9212-02



9212-05



9212-03







# Pneumatic Tools

**1 rechargeable battery for all devices!**

## Cordless drilling machine 18 V

- Compatible with HAZET rechargeable batteries 9212-02 and 9212-05
- Tool-free metal quick-clamping drill chuck 1-13 mm
- Incl. quick charger (40 minutes)
- Selectable torque stages 15 + 1 drilling

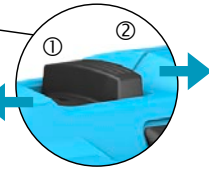

2.0 AH

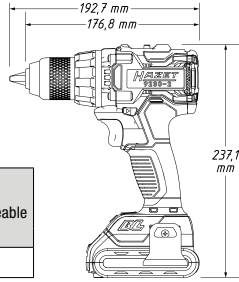

max. Nm	rpm	rpm	dB(A) Lp A	m/s <sup>2</sup> Screwing	m/s <sup>2</sup> Drilling	Without rechargeable battery
60	① 0-560	② 0-1900	68	0.8	2.3	1.27

HAZET No.	Designation		EAN-No. 4000896 +
9230-2	3-piece set, contents: 1 cordless drill, 1 quick charger, 1 Li-ion rechargeable battery 18 V, 2.0 Ah	3	218370
9230-2/4	4-piece set, contents: 1 cordless drill, 1 quick charger, 2 Li-ion rechargeable batteries 18 V, 2.0 Ah	4	218967

## Right-angle grinder 18 V

- High efficiency thanks to brushless motor
- Ergonomic and compact housing design
- Device stops if the speed drops sharply due to canting
- With function against unintentional motor start when changing the battery
- Mesh fabric protects motor from dirt
- Motor stop 2 seconds after switch-off
- Extremely flat head with low angle
- Constant speed even during difficult work
- Soft startup for greater comfort
- With safety lever
- Quick adjustment (without tools) of protection cover
- Spindle thread: M14



rpm	dB(A) Lp A	m/s <sup>2</sup>	mm	With rechargeable battery	Without rechargeable battery
8000	89	7.9	345	2.28	1.53

HAZET No.	Designation		EAN-No. 4000896 +
9233-7	3-piece set, contents: 1 cordless right-angle grinder, 1 quick charger, 1 Li-ion rechargeable battery 18 V, 5.0 Ah, in plastic case	3	218325
9233-7/4	4-piece set, contents: 1 cordless right-angle grinder, 1 quick charger, 2 Li-ion rechargeable batteries 18 V, 5.0 Ah, in plastic case	4	218950

## Accessories

HAZET No.	Designation	EAN-No. 4000896 +
9230-010	Drilling machine basic unit (without rechargeable battery)	218974
9233-010	Right-angle grinder basic unit (without rechargeable battery)	218943
9212-02	Replacement battery 2.0 Ah	213788
9212-03	Quick charger for rechargeable batteries	204823
9212-05	Replacement battery 5.0 Ah	210367
9233-010/5	Cut-off wheel set, 5 pieces	219063
9233-011/10	Grinding wheel set, 10-piece	219087
9233-010/25	Cut-off wheel set, 25 pieces	219070





Das Werkzeug

# Workshop tools



## 196 N-1

EAN-No. 4000896208258

### Universal fender cover

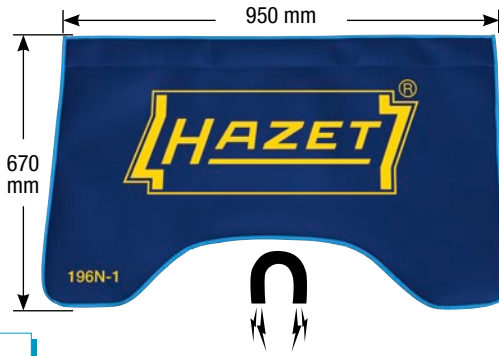

Made in Germany



## 196-6/2

EAN-No. 4000896150151

### Steering wheel and seat cover set

- One size fits all
- Waterproof, oil and grease repellent
- Tested with side airbag
- Antistatic
- Fire safety complies with British and US Fed 302 standards



## 196-2

EAN-No. 4000896149469

### Fender cover

- Made of specially coated anti-slip material
- Waterproof, oil and grease repellent
- Cover adheres vertically to almost all car body surfaces
- Fire safety complies with British and US Fed 302 standards



## 4850-1

EAN-No. 4000896022366

### Nozzle adjustment tool

- For adjusting the nozzles of the windscreen washing systems
- The telescopic handle can be used to indicate the nozzle jet direction to the windscreen
- With magnetic head 6 mm Ø, adjusting needle, protective cap



Top seller!



## 4852/4

EAN-No. 4000896210114

### Dashboard protection with handle

- For protection against damage to the dashboard, interior lining and vehicle headlining when removing windows
- The light blue colour draws attention to soiling on the individual protection panels quicker than conventional grey protective panels do and therefore prevents the interior from being soiled
- Suitable for a wide range of spatial conditions
- Sturdy plastic

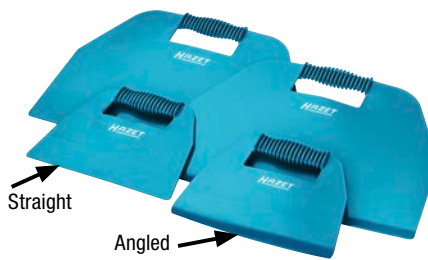

Contents:

- Protection panel, angled, 270 x 200 mm, 450 x 300 mm
- Protection panel, straight, 270 x 200 mm, 450 x 300 mm



## 1977-2/4

EAN-No. 4000896150144

### Telescopic inspection mirror set

- Double hinge with tension spring

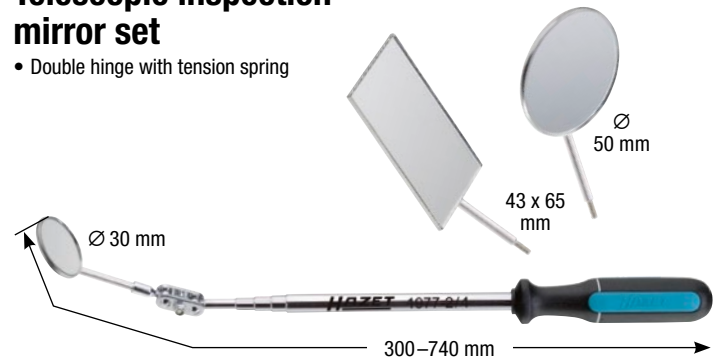

## Gloves



1987 N-4

1987-5

HAZET No.	Description	EAN-No. 4000896+
1987 N-4	Gloves, with micro-foam coating	203840
1987-5 L	Mechanic's gloves	181735
1987-5 XL	Mechanic's gloves	181759

## Kneeling mat / mechanic's mat

- Easy-to-clean surface



Made in Germany

HAZET No.	Description	EAN-No. 4000896+
195-1	Kneeling mat H30 x W450 x D210 mm	121069
195-5	Mechanic's mat (not shown) H30 x W975 x D385 mm	153718





## Workshop tools

### 195-2 Mechanic's creeper

4.6 kg

**Improved sturdy design**

up to 130 kg



### 195-3 Creeper

EAN-No. 4000896148691

**Combines creeper and seat**  
Quick and easy conversion from creeper to seat and vice versa

- Cushioned sitting and lying surface
- Easy to clean

up to 150 kg



### 195-4 Pneumatic chair

EAN-No. 4000896148707

- Easy to clean
- Weight capacity up to 150 kg
- Tilt-resistant

**Improved sturdy design**



### 199 N-1 Pressure sprayer

EAN-No. 4000896189007

**For spraying with chemical and highly corrosive substances!**

- New capped pumping mechanism increases chemical resistance
- Integrated safety valve (2.5 bar)
- Viton® gaskets
- Permissible operating pressure: max. 2.5 bar
- Flow rate: 0.5 l/min. at 2.5 bar
- 0.8 l/min. at 2.5 bar, optionally using the flat spray nozzle (included in delivery)



### 199-3 Pressure foam sprayer

EAN-No. 4000896207237

YouTube clip



### For creating tight and permanent foam!

- Cleaning / disinfecting of surfaces, tools, vehicles, sanitary facilities
- Suitable for neutral cleaners as well as diluted acid and alkaline cleaners
- Transparent, durable tank with level indicator
- Integrated safety valve (2.5 bar)
- Viton® gaskets
- Wet and dry foams can be generated by using different nozzles, to achieve various exposure times.

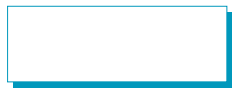

### 199-4 Spray bottle, refillable

EAN-No. 4000896198429

- Filling with compressed air via the valve located in the floor
- With Viton gasket

#### Spare parts:

199-4-01/2  
EAN-No. 4000896206568  
Nozzle set



199-4-04/4  
EAN-No. 4000896206575  
Pump unit, complete



199-4-03/5  
EAN-No. 4000896208265  
Sealing ring set



HAZET No.	g gross	Volume ml	max. bar	l mm
199-4	450	0 - 230	8	115



Das Werkzeug

# Workshop tools



## 2157-1 Jack-knife

- Quick blade changing
- With 5 spare blades



HAZET No.	Description	l mm	g	EAN-No. 4000896 +
2157-1	Jack-knife	155	140	147236



## 1979 N-71 LED penlight



## 1979 N-72 LED torch light



## 1979-73 LED torch light



HAZET No.	Description	l mm	g	Operating time (h)	Range of light (m)	Protection rating IP	Luminous flux Lumen	Battery	EAN-No. 4000896 +
1979 N-71	LED penlight	139	64	4.0	75	54	130	2 x AAA-1.5 V batteries (incl.)	208470
1979 N-72	LED torch light	135	112	4.5	175	54	200	3 x AAA-1.5 V batteries (incl.)	208487
1979-73	LED torch light	236.5	215	6.6	258	67	500	3 x C-1.5 V batteries (incl.)	186037

## 1979 N-35 LED headlamp



## 1979 N-81 LED folding light



## 1979 N-7 LED folding light



HAZET No.	Description	l mm	g	Operating time (h)	Range of light (m)	Protection rating IP	Luminous flux Lumen	Battery	EAN-No. 4000896 +
1979 N-35	LED headlamp	-	120	3.0	165	64	280	Rechargeable batteries: 3 x 1.5 V Micro / AAA / (L)R03	201631
1979 N-81	LED folding light	126	185	4.0	40	54	250	Permanently built-in Li-Ion battery pack 3,7 V, 1550 mAh	218783
1979 N-7	LED folding light	255	314	3.5	50	54	275	3,7 V, 2600 mAh (rechargeable Li-Ion battery)	208241





# Workshop tools

## 4812-10/4 S, EAN-No. 4000896181742

### Video borescope with 4.9 mm Ø switch probe

- Incl.:
- SD card with 4 GB storage capacity
  - 4 x AA batteries
  - Hook with magnet
  - Plastic case

All in one! Viewing, recording, replay on TFT display!

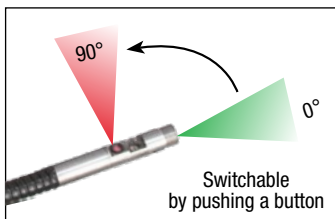

## 4812N-10/3AF

EAN-No. 4000896219131

### Video borescope with new swivelling probe

- Single 180° swivel enables e.g. a real reverse view onto valves in the cylinder
- Camera head only 11 mm long (-50 % compared to conventional designs)
- Bending radius only approx. 35 mm (-30 % compared to conventional designs)
- With light boost and integrated reflection reduction
- Micro-lens: 4.5 mm Ø - Front view with a resolution of 640 x 480 pixel
- Casing made from steel mesh
- **Contents:**
  - 1 m probe cable with 4.5 mm Ø micro-lens and 4 dimmable LEDs
  - 1 operating panel
  - 1 SD card 4 GB
  - 4 AA batteries

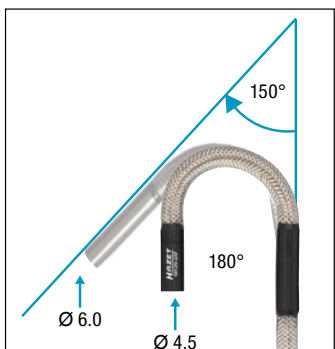

## 4 Probes for video borescope

- 4812-16** EAN-No 4000896181841  
Ø 4,9 mm / 0° + 90°
- 4812 N-1S** EAN-No 4000896187102  
Ø 3,9 mm / 90°
- 4812 N-1F** EAN-No 4000896187096  
Ø 3,9 mm / 0°
- 4812 N-5.5** EAN-No 4000896187065  
Ø 5,5 mm / 0°
- 4812-20** EAN-No 4000896181087  
Old probes (4812-) and adapter (4812-20) for new operating panels
- 4812-30** EAN-No 4000896189069  
New probes (4812 N-) and adapters (4812-30) for older operating panels
- 4812 N-2 AF** EAN-No. 4000896218868  
Swivelling probe individual: 1 m probe cable with Ø 4.5 mm micro-lens and LED light source



Das Werkzeug

# Wheels | Tyres



## 197-3

EAN-No. 4000896158584

### Magnetic cup

- Holds small parts such as screws etc.
- Magnetic foot allows fixation to tool trolleys, workshop panels, car lifts etc.



**Top seller!**

Plastic  
150 mm Ø



## 9070-10

EAN-No. 4000896158157

### Magnetic holder

- With two strong magnets to hold 1 impact wrench 4 sockets 1 torque wrench
- Loading capacity: 10 kg

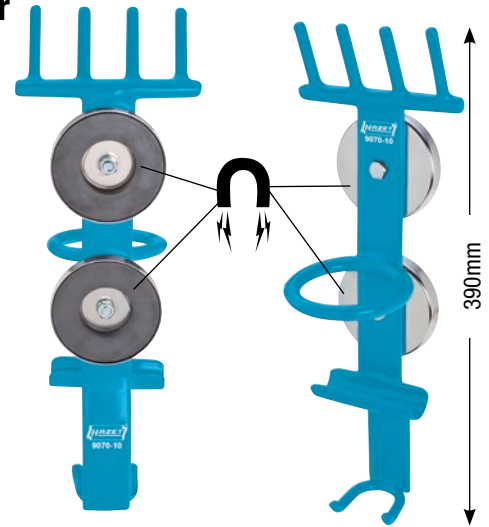

## 669/10

EAN-No. 4000896191079

### Tyre pressure control system tool set (TPCS)

- With torque screwdriver (0.4 – 1.4 Nm) and torque wrench (1 – 9 Nm)
- Easy and professional installation of sensor and valve on every rim
- For installing and removing tyre valve cores
- SmartCase (1/3) 165-L
- Safety-Insert-System, 2-component soft foam insert. Insert also suitable for HAZET Assistent



**0.4 – 9 Nm!**



669/10

1 x		0.4 – 1.4 Nm, 3 pieces
2 x		s 11 12 mm
3 x		T10 T15 T20
1 x		1 – 9 Nm
1 x		Tyre valve bit insert

YouTube clip



Made in Germany

HAZET No.	Description	EAN-No. 4000896 +
6001-0.6/3	Torque screwdriver 0.1 – 0.6 Nm, 3 pieces	199617

## Impact socket (6-point)

- Operation via impact adapter e.g. HAZET 1003S-1 or nut-driver s 24 mm enables high force transmission thanks to optional  $20 \frac{3}{4}$  drive
- Especially stiff wheel bolts can be loosened more easily via an optional  $20 \frac{3}{4}$  impact wrench
- Especially suitable for vans and light trucks, e.g. FIAT Ducato, MERCEDES-BENZ Sprinter
- Outside 6-point mounted on the socket enables adaptation to  $20 \frac{3}{4}$  drive
- Plastic casing protects rims against encrusted dirt

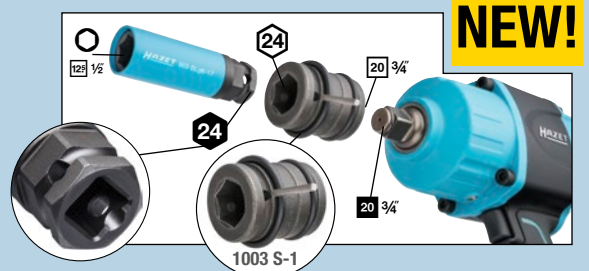

**NEW!**

## 903 SLg6-17

EAN-No. 4000896223596

$12 \frac{1}{2}$  NEW!



s 17 mm

Made in Germany

## 903 SLg6-19

EAN-No. 4000896223589

$12 \frac{1}{2}$  NEW!



s 19 mm

Made in Germany

## 903 SLg6/5

EAN-No. 4000896223602

$20 \frac{3}{4}$   $12 \frac{1}{2}$  NEW!



Made in Germany





## Impact socket (6-point)

### Rotating

903 SLg



12<sup>5</sup> 1/2

s 17 mm



Made in Germany

HAZET No.	S mm	l mm	EAN-No. 4000896 +
903 SLg-17*	17	85	045822
903 SLg-19	19	85	045839
903 SLg-21	21	85	055135
903 SLg-22	22	85	155453

\*17: optimised contours for deeper rim holes in e.g. AUDI S-Line, AMG, OZ etc.

### 903 SLg-15

EAN-No. 4000896072231

- Material-friendly wheel mounting or dismounting (alloy rims) s 15 mm
- Especially for SMART FORTWO

s 15 mm

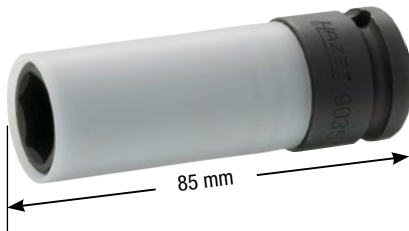

Made in Germany

### 903 SLg-17/3 / 903 SLg-19/3

- With hanging hole



3 sockets each in a practical storage box!

Made in Germany

HAZET No.	S mm	l mm	EAN-No. 4000896 +
903 SLg-17/3	17	85	191697
903 SLg-19/3	19	85	191734

### 903 SPC/3

EAN-No. 4000896128754

Set!

Made in Germany



s 17 mm  
s 19 mm  
s 21 mm

### Rotating | Extra long

904 SLg-17, EAN-No. 4000896100576

12<sup>5</sup> 1/2

s 17 mm

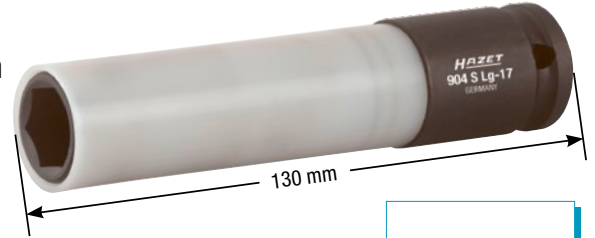

Made in Germany

904 SLg-19, EAN-No. 4000896203710

12<sup>5</sup> 1/2

- Particularly suitable for wheel mounting and assembly on SUVs e.g. PORSCHE Cayenne, Macan; AUDI Q7, Q5; VW Touareg

s 19 mm



Made in Germany

### With special profile

905 SLg-21, EAN-No. 4000896201624

12<sup>5</sup> 1/2

- Applications include HYUNDAI i30, Tucson and KIA

s 21 mm



Ø 31 mm



Made in Germany

905 SLg-17, EAN-No. 4000896198795

12<sup>5</sup> 1/2

- Especially for wheel mounting and dismounting of light-alloy rims for hybrid wheel bolts in all new MERCEDES-BENZ vehicles
- For e.g. MERCEDES-BENZ C Class type 204, 204X, E Class type 211, 212, 207; SLK type 172; M Class type 164, 166; S Class type 221, 222, CL Class type 216

s 17 mm



Ø 28 mm



Made in Germany



## Wheel hub grinder

- ✓ Prevents incorrect wheel bolt tightening torque caused by corrosion
- ✓ Quick and easy removal of rust and dirt from contact surfaces of wheel hubs and brake discs with wheel bolt support
- ✓ Wear-resistant: approx. 100 vehicles per wheel
- ✓ Open-pored abrasive material and cup-shaped grinding disc reduce the formation of dust to a minimum
- ✓ No formation of sparks

### 4960 R-160/4

EAN-No. 4000896218820

- 11 mm outside hexagon with 3 contact surfaces for attachment e.g. to pneumatic, cordless and corded drilling machines
- Contents (4-piece set):  
 1 base component  
 3 grinding wheels Ø 160 mm



s 11 mm ◯



∅	↻	∅
Inside	rpm	Passenger car wheel hub
75 mm	500	160 mm

4



YouTube clip

### 4960 R-0160/3, EAN-No. 4000896218790

## Spare grinding wheels

- With hook and loop fastener for quick changing of grinding wheels
- 3 spare grinding wheels Ø 160 mm



3

### 4960 V-160/2

EAN-No. 4000896218394

- With 12<sup>5</sup>/<sub>16</sub> inside square collet for attachment e.g. to pneumatic, cordless and corded impact wrenches
- Contents (2-piece set):  
 1 base component  
 1 grinding wheel Ø 160 mm



12<sup>5</sup>/<sub>16</sub>



∅	↻	∅
Inside	rpm	Passenger car wheel hub
75 mm	500	160 mm

Before



After



12<sup>5</sup>/<sub>16</sub>

2



YouTube clip

### 4960 V-0160/3, EAN-No. 4000896218813

## Spare grinding wheels

- With hook and loop fastener for quick changing of grinding wheels
- 3 spare grinding wheels Ø 160 mm



3

### 4960 F-160/2

EAN-No. 4000896218387

## Rim flange cleaner

- For optimum cleaning of the contact surface on the rim inside
- 11 mm outside hexagon with 3 contact surfaces for attachment e.g. to pneumatic, cordless and corded drilling machines
- With centre hole guidance and integrated sander for cleaning the wheel centring
- For wheel centring diameter: min. 51 mm
- Contents (2-piece set):  
 1 base component  
 1 grinding wheel Ø 160 mm



s 11 mm ◯



YouTube clip

### 4960 F-0160/3, EAN-No. 4000896218806

## Spare grinding wheels

- With hook and loop fastener for quick changing of grinding wheels
- 3 spare grinding wheels Ø 160 mm



3

↻	∅
rpm	Passenger car wheel hub
500	160 mm





# Wheels | Tyres

## 4960 N-45/12

EAN-No. 4000896186860

### Wheel hub grinder set for PASSENGER CARS

- Base component made of aluminium with 8-point profile enables safe and firm attachment of the grinding wheels
- With hexagon insert for firm hold at the device
- For wheel hubs with stud bolts (diameter of grinding zone 40 or 50 mm), e.g. **FORD, PORSCHE, Volvo**, Japanese passenger cars
- Wear-resistant: approx. 50 vehicles per wheel
- **Contents (12-piece set):**
  - 1 Aluminium base component
  - 6 grinding wheels  $\varnothing$  50 mm
  - 5 grinding wheels  $\varnothing$  40 mm



12

### Spare grinding wheels

- Hook and loop fastener for quick changing of grinding wheels
- 5 Spare grinding wheels (small)

#### 4960 N-50/5

EAN-No. 4000896187126

$\varnothing$  50 mm



5

#### 4960 N-40/5

EAN-No. 4000896187232

$\varnothing$  40 mm



5

## 9041 D-1

EAN-No. 4000896212378

### Tyre inflator, digital

- Optimal readability even in poor light conditions
- Hose with plug-in nipple
- Handle with integrated suspension hook
- Manometer measuring range: 0–12 bar, graduation: 0,01 bar
- Manometer diameter: 63 mm
- Display toggles between bar / PSI / kg/cm<sup>2</sup>
- Manometer can be turned

Device dimensions:  
262 x 105 x 40 mm



mm  
400



HAZET No.	g	max. bar
9041 D-1	0,385	12

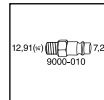

## 9041 G-1

EAN-No. 4000896212385

### Tyre inflator, calibrated

- Calibrated device with optimally readable, large manometer
- Hose with plug-in nipple
- Handle with integrated suspension hook
- Manometer measuring range: 0–10 bar, graduation: 0.1 bar
- Manometer diameter: 80 mm

Device dimensions:  
220 x 150 x 90 mm

mm  
1000  
Flexible hose



HAZET No.	g	max. bar
9041 G-1	0,585	10

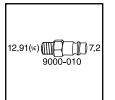

## 9041-1, EAN-No. 4000896147076

### Tyre inflator

- Handle with operating lever and discharge knob, hose with integrated plug-in nipple
- Max. pressure: 8 bar

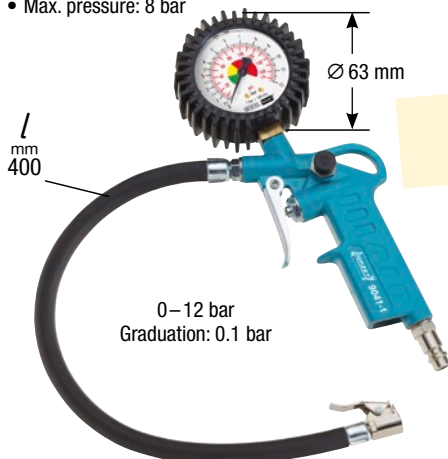

mm  
400

0–12 bar  
Graduation: 0.1 bar

mm  
63

**Top seller!**

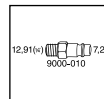

## 705 V

EAN-No. 4000896196388

### Four-way rim wrench for cars

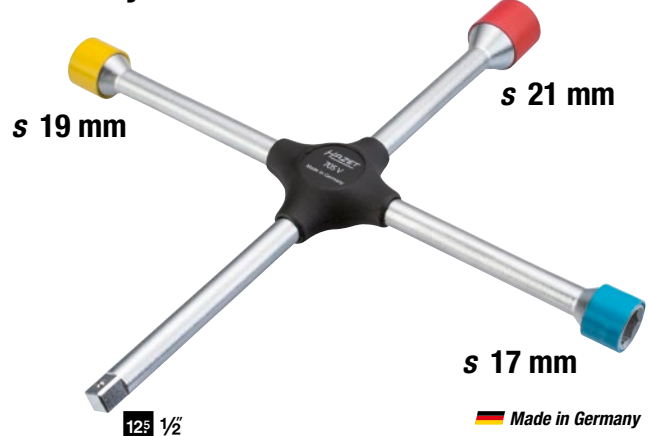

s 19 mm

s 21 mm

s 17 mm

12<sup>5</sup> 1/2

Made in Germany



## 4591/4

EAN-No. 4000896219650

### Pipe stopper set, 4 pieces

- Very quick closure of pipes prevents liquids from escaping
- For sealing pipelines in brake systems, air conditioning systems, power steering and fuel systems that cannot be secured with a flexible hose clamp
- For single sealing in sizes of 6,3 mm (1/4") - 8 mm (5/16") - 10 mm (3/8") and for double sealing (e.g. banjo connections) in size 10 mm (3/8")



**NEW!**

4

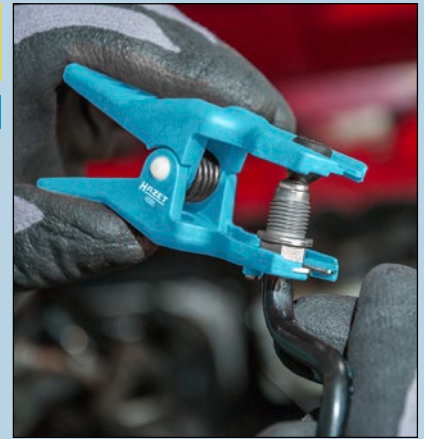

## 4760-11

EAN-No. 4000896222346

### Disassembly/Assembly auxiliary tool

- For securely holding **glow and spark plugs**
- Prevents the glow and spark plugs from falling down and becoming damaged during disassembly/assembly
- Auxiliary tool for screwing and unscrewing glow and spark plugs, especially in constricted spaces
- Full rubber design
- Length of 230 mm enables more careful threading and unthreading

**NEW!**

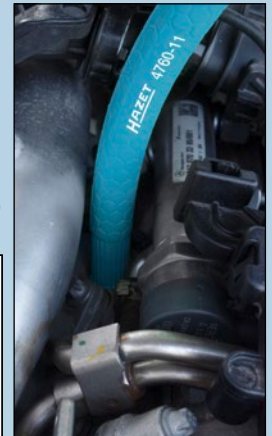

## 4798-6/8

EAN-No. 4000896210763

### Universal injector extractor tool set

- Enables the removal of the injectors without removing the electrical connector or injector head
- Advantage: without any previous injector defect, reinstallation is possible without recalibration
- Universal set for removing diesel injectors on the brands **Bosch, Delphi, Siemens, Denso** using a sliding hammer



*Incl. special adapter!*

8

YouTube clip



## 4798-7/14

EAN-No. 4000896210756

### Universal injector tool set, Denso

- Enables the removal of the injectors without removing the electrical connector or injector head
- For **Denso** injectors: 23670 → 30080; MB416600 → MB40A; 5870 → 13H50B; 11L 12182; 23670 → 26011; 23670 → 0R050; 10J 06798. Installed on e.g. **TOYOTA, NISSAN, MAZDA, OPEL / VAUXHALL, LEXUS**
- The extractor system securely grips the supply and overflow oil line connection
- Including 5 injector adapters and sliding hammer



14

YouTube clip

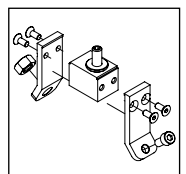
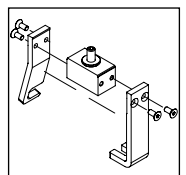





## 4798-5/25

EAN-No. 4000896210688

### Universal injector removal tool set, mechanical with Bosch adapter

- Huge amount of time saving since neither cylinder head nor engine have to be removed
- Especially for disassembling very tight injectors
- Heavy duty supporting bridge can be individually adapted to the space available and supporting options on the cylinder head
- Feed shaft M18 and thrust bearing ensure high tractive power
- Including adapter for **Bosch** solenoid valve injectors
- Removal of **Siemens**, **Denso** and **Delphi** injectors using the optionally available accessories



25

Optionally extendable with hydraulic cylinder, e.g. HAZET 12 t (4798-9/6) or 20 t (4798-20)

YouTube clip



h x w x d:  
120 mm x 490 x 410 mm

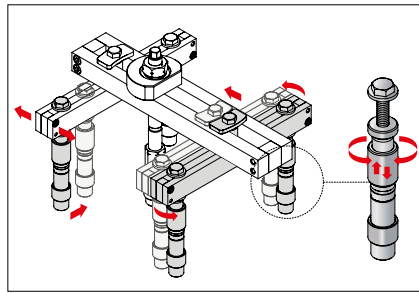
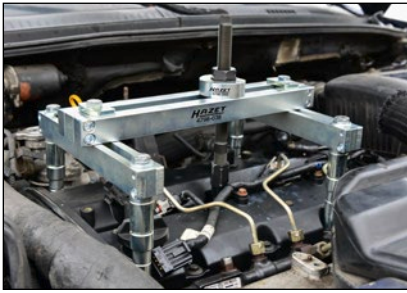

4798-15



4798-16



4798-17



4798-13



4798-14



4798-18

HAZET No.	■	S mm	Injector socket	EAN-No. 4000896 +
4798-15	128 1/2	25	Siemens	210640
4798-16	128 1/2	27	Siemens	210657
4798-17	128 1/2	28	Bosch	210664
4798-13	128 1/2	29	Bosch	210527
4798-14	128 1/2	30	Bosch	210633
4798-18	128 1/2	10	Special screwdriver socket for solenoid valve screw connection	210695

## 4798-11/5

EAN-No. 4000896210671

5

### Injector adapter set, Bosch

- Expansion set with spindle and thrust bearing
- For engines in which 2 injectors are held with a double holder, whereby 2 injectors always have to be extracted at the same time during removal
- Spindle M18 x 1.5, length: 220 mm
- For use with HAZET 4798-5/25



## 4798-12/13

EAN-No. 4000896210701

13

### Injector adapter set RENAULT

- Creates a straight contact surface for injector tools to perform an optimal disassembly procedure of the injectors
- For **RENAULT** 2.0 dCi M9R engines with piezo injectors
- Expansion set with special supporting crossbars and feed shaft
- For use with HAZET 4798-5/25



## 4798-22

EAN-No. 4000896210510

### Adapter plate, RENAULT

- Lateral mounting of the plate on the engine creates a straight contact surface for HAZET 4798-5/25
- For **RENAULT**, **OPEL**, **NISSAN** 2.2 → 2.5 dCi / engine code G9T, G9U





**NEW!**

**4562-1**

EAN-No. 4000896222353

## Operating tool for Henn® clamps

- Universally in use for proper operation of Henn clamps on cooling water and charging air hoses. **Handle shift enables operation even on Henn clamps that are difficult to access**
- Length: 100 mm
- Width: 20 mm (in the functional range)



Handle can be shifted by 90°



Made in Germany

**4798-21/2**

EAN-No. 4000896210770

## Injector adapter set, Siemens

- Enables partial disassembly of the injector and therefore also direct connection with a feed shaft
- For disassembling **Siemens** injectors M25 x 1 and M14 x 1
- For use with HAZET 4798-5/25



**4798-10/3**

EAN-No. 4000896210725

## Injector adapter set, Denso

- Enables partial disassembly of the injector and therefore also direct connection with a feed shaft
- For disassembling **Denso** injectors M25 x 0.75 and M25 x 0.5
- For use with HAZET 4798-5/25



**4798-8/8**

EAN-No. 4000896210749

## Injector removal tool MERCEDES-BENZ (Bosch / Delphi), 12 t

- Huge amount of time saving since the engine does not have to be removed to disassemble the injectors
- The 12 t hydraulic cylinder enables simplified loosening of very tight injectors
- For **MERCEDES-BENZ** 2.1 I, 2.2 I, 3.0 I V6 (CDI 2.1 I, 2.2 I **Delphi**, CDI 3.0 I V6 Bosch), Vito, CLK, Sprinter, Viano, Vario as well as M, GL, C, GLK, E, CLS, S, R, G-Class, **CHRYSLER** 3.0 I V6
- Operation of hydraulic cylinders using e.g. HAZET 600N-19

*Approx. 6 hours  
 time saving possible!*



YouTube clip







# Oil service



Das Werkzeug

## 3420-1

EAN-No. 4000896224159

### FORD socket for plastic oil drain plug

- Perfectly designed for plastic oil drain plugs
- Prevents damage resulting from the use of e.g. unsuitable extraction tools
- Special socket for operating the plastic oil drain plug for e.g. **CITROËN** C4, C5, Spacetourer, Jumpy, DS4, DS5 with 2.0 Blue HDi engine since 09.13-; **FORD** Mondeo, S-Max, Kuga, Galaxy, Focus, C-Max with 2.0 TDCi engine since 09.14-; **FORD** (USA) Edge with 2.0 TDCi engine since 08.15-; **FORD** (Australia) Kuga, Escape, Mondeo with 2.0 TDCi engine since 09.14-; **OPEL** Grandland X 2.0 D since 11.17-; **PEUGEOT** 308, 508, 3008, 5008, Expert, Traveller with 2.0 Blue HDi engine since 11.13-; **TOYOTA** Proace Verso, bus, box, platform with 2.0 D engine since 02.16-; **OPEL/VAUXHALL** Grandland X 2.0 D since 10.17-
- Length: 32 mm



14 mm

**NEW!**

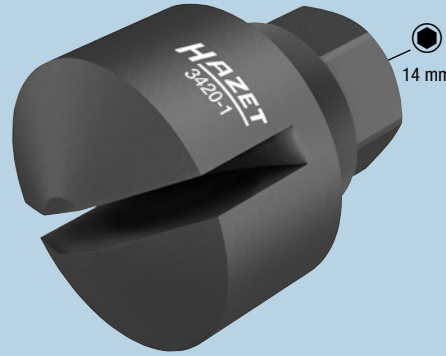

Made in Germany

## 850 LG-GE 10

EAN-No. 4000896223572

### TORX® articulated wrench socket

- Disassembly of the gearbox holder: time saving approx. 20 minutes
- Much better accessibility of the screw connection on EGR valve and cooler enables further time saving approx. 15 minutes
- For operating the oil pan screw connection in the engine and automatic gearbox and for removing the EGR cooler, EGR valve, valve cover etc. in **MERCEDES-BENZ** etc. in the OM 651 engine
- Use and extension permanently connected
- Output: TORX E 10
- Total length: 150 mm

6.3 1/4

**NEW!**



E 10

6.3 1/4

Made in Germany

## 197 N-1 / 197-2

### Multifunctional drain pans



HAZET No.	Contents l	EAN-No. 4000896+	
197 N-1	6	198924	
197-2	16	146802	

## 197-50, EAN-No. 4000896210008

### Multifunctional drain pan, 50 l

- Resistant to acid and alkaline solutions
- Can be used as a cleaning pan, dirt pan, oil pan, storage pan, disinfection pan, leakage pan, transport pan, feed pan
- Can be used in sanitary and heating construction, the motor vehicle industry and workshops, for hunting equipment, chemical/laboratory use, food industry/butcheries, fishing, pet supplies, horse accessories, etc.
- From TÜV-certified production in accordance with DIN ISO 16901

**Universal application with huge capacity!**

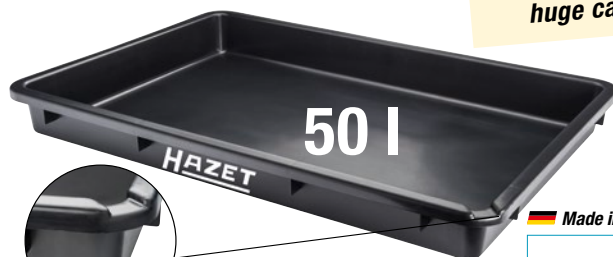

Made in Germany

Internal dimensions (W x D x H):  
800 x 520 x 100 mm





Das Werkzeug

# Brakes



## 4968/14A

EAN-No. 4000896221158

### Universal brake tool set

- All important tools for professional brake disassembly/assembly as well as for cleaning with direct access
- Revised set contents adapted to today's needs

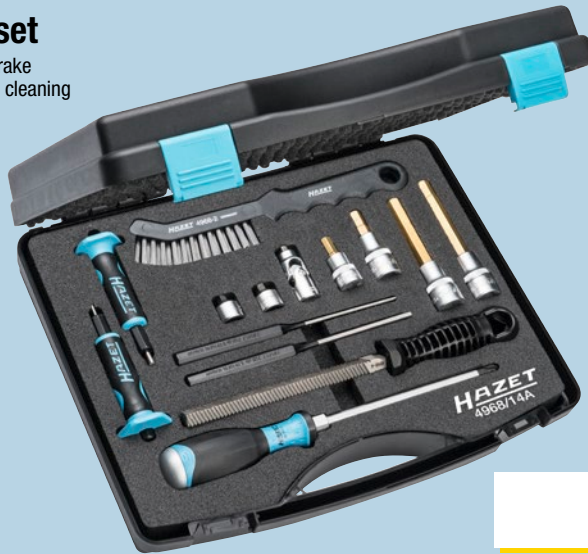

14 **NEW!**

## 4968/2H

EAN-No. 4000896221820

### Hook set

- Surface dip-insulated
- Length: 190 mm
- Hook  $\varnothing$ : 7 mm

2 **NEW!**

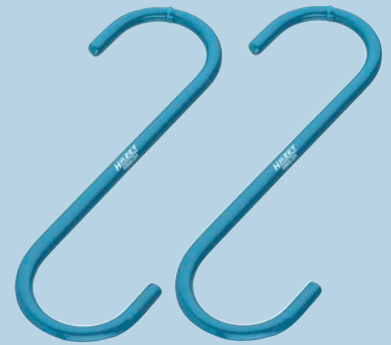

1x		4968-6
1x		4968-2
4x		751KHS-3 · 751KHS-4 748LGB-3 · 748LGB-4
1x		810U-PH3
1x		8801K-7
1x		986LG-11
1x		2784-1
1x		2584-8
1x		2901G-7
1x		986-9
1x		986LG-9

## 163-548/14

EAN-No. 4000896224197

### Universal brake tool set, individually in 1/3 insert



1/3

## 986 Lg-11, EAN-No. 4000896216536

### Brake calliper screwdriver socket

- Problem-free operation of the brake calliper fitting
- Brake calliper screw connection on:  
 e.g. **MERCEDES-BENZ** ML-Class, Type 166, model years 2011 →,  
**FORD** Mondeo model years 2014 →,  
 C-Max, S-Max and Galaxy model years 2015 →

s 11 mm



12 1/2 **TIN**

12 1/2

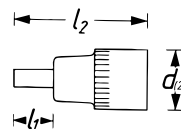

$l_1$ mm	$l_2$ mm	$d_2$ mm
60	98	23

Made in Germany

## 4968-6, EAN-No. 4000896218431

### Square brake calliper file

- Extra slim design
- For easy removal of stubborn brake dust, rust and dirt from the brake calliper
- 10 x 10 mm



$l_1$ mm	$l_2$ mm
155	265

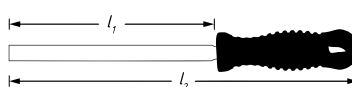

Made in Germany

## 4968-12, EAN-No. 4000896219964

### Brake line scraper

- Curved design enables work even in cramped and hard-to-reach areas
- For removing dirt, underbody protection and rust on brake lines, application is possible by pulling or pushing
- Replaceable blade
- For brake line  $\varnothing$  4.75 mm



$l$ mm
245



Made in Germany





# Brakes

4956-4

EAN-No. 4000896222339

## Brake disc vernier calliper / diameter

- Rapid determination of the brake disc diameter, without disassembling the wheels, helps avoid incorrect orders
- For determining the brake disc diameter through rim openings
- **Measuring range: 200 - 400 mm**

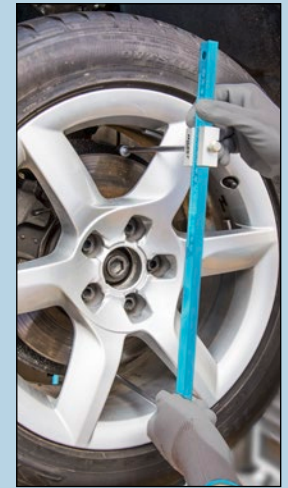
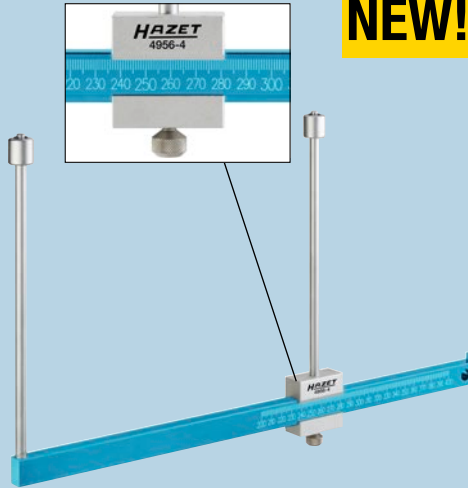
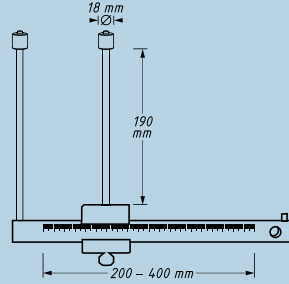

4956-3, EAN-No. 4000896219032

## Calliper gauge for brake discs / thickness gauge

- **Measurement without wheel removal**
- Effortless measurement on the vehicle in the course of direct receptions in the presence of the customer
- **Measuring range: 0 - 60 mm** (also suitable for application on commercial vehicles)
- Easy application
- **Note:** Information on the wear limits – Please observe vehicle manufacturer's data!
- Length: 395 mm



## 1847 Clamp pliers



1847-1



1847-90

90°

YouTube clip



1847/3

3

90°

1847

1847-090/2



1847-02/2

Made in Germany



HAZET No.	Description	Application / mounting	EAN-No. 4000896 +
1847-1	Pliers for axle boot clamps	For passenger car axle boot strips. For e.g. on VW, AUDI, OPEL/VAUXHALL, BMW, MERCEDES-BENZ, HONDA, NISSAN, MAZDA	007004
1847	Clamp pliers for axle boots	For installing axle boots made of Hytrel and clamps made of special stainless steel with pre-set torque values, in conjunction with e.g. torque wrench HAZET 6110-1 CT	050918
1847/3	Clamp pliers for axle boots 1847 with replaceable jaws 90° (1847-090/2)		206902
1847-90	Clamp pliers for axle boots 90°, angled	Collet chuck 90° for activating stainless steel bands with specified torque tightening values	206728
1847-090/2	Pair of clamping jaws, angled 90°	Pair of clamping jaws 90° for difficult to access stainless steel bands	206711
1847-02/2	Pair of clamping jaws for 1847 (yields pliers 1847-22)	Pair of clamping jaws for steering gear boots AUDI A4 / A5 / A6 / A7 / Q5	174447



15

**NEW!**

## 1847-12/15

EAN-No. 4000896221288

### Circlip pliers set

- Easier, damage-free assembly of the drive shaft joint: Damage to the serration of joint and shaft is avoided with internal circlip during assembly of the drive shaft joint
- Correct, centred insertion of the circlip when mounting the joint on the drive shaft
- Easy fixing of the locking pliers over the circlip without damaging the bellows
- The pliers automatically slip down when striking the joint
- Suitable for drive shafts from all manufacturers
- No other tools needed

#### Contents:

- 1 circlip pliers 1847-12
- 7 pairs of half shells in graduated diameter sizes:
- Half shells  $\varnothing$  : 19 · 21.4 · 22.3 – 23 · 23.8 – 24.6 · 26.2 – 26.9 · 28.5 – 29.2 · 30 mm

YouTube clip



#### Application tip:

- Insert appropriate half shells in pliers depending on shaft diameter
- Place pliers on serration with pre-assembled circlip and clamp
- Pre-positioning of the joint due to conical shape of the pliers makes it easier to introduce the serration without damage

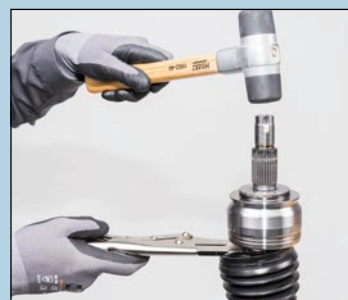
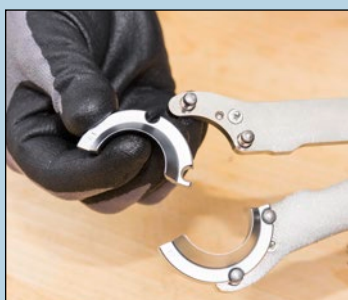

Made in Germany







# Chassis | Cardan shafts



Das Werkzeug

4933-1/11

EAN-No. 4000896223022

## Double cone wheel bearing tool set

- For unscrewing e.g. screwed wheel bearings in combination with HAZET sliding hammer 1969-17. Can be used for almost all wheel bearings
- In soft foam insert

### Contents:

- 1 x spindle total length: 305 mm  
Outside thread TR20 x 3
- Inside thread M20 x 1.5
- 2 x spindle nut TR20 x 3
- 2 x lock nut TR20 x 3
- 6 x cone



11 **NEW!**

YouTube clip



Made in Germany

1969-17

EAN-No. 4000896223015

## Sliding hammer

- Striking weight: 6 kg
- Coupler thread: M20 x 1.5
- Total length: 890 mm

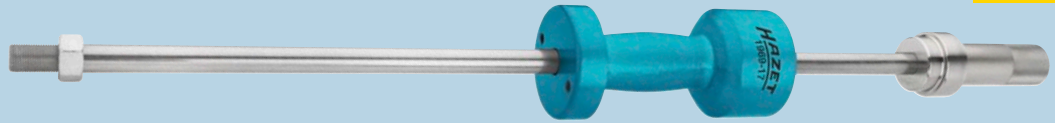

12 **NEW!**

4935-11/12, EAN-No. 4000896217434

## Drive shaft disassembly / assembly set

- For disconnecting the drive shaft joint and pulling in the shaft through the wheel hub with just one tool
- Disconnecting the drive shaft joint from the shaft using the sleeves or spindles in conjunction with e.g. HAZET sliding hammer 4797-1 (not included)
- Pulling in the drive shaft through the wheel hub on vehicles where the drive shaft is very difficult to pull through the wheel hub
- Suitable for all vehicle brands
- For drive shafts with outside and inside thread

### Contents (12-piece set):

- 2 Spindles (M14, M16) for pulling the drive shaft through the wheel hub or for disconnecting the joint from the shaft in case of joints with inside thread
- 2 Sleeves for supporting on wheel hub
- 1 Spindle nuts
- 7 Screw sleeve adapters
  - M16 x 1.5 (VAG, MAZDA)
  - M18 x 1.5 (Volvo, SUZUKI, OPEL/VAUXHALL)
  - M20 x 1.5 (MERCEDES-BENZ, VAG, MITSUBISHI, MAZDA)
  - M22 x 1.5 (FIAT, PSA, BMW, FORD, OPEL/VAUXHALL, HYUNDAI)
  - M24 x 1.5 (RENAULT, BMW, MERCEDES-BENZ, OPEL/VAUXHALL, MAZDA, HONDA, VAG)
  - M27 x 1.5 (PSA, BMW, FORD)
  - M30 x 1.5 (MERCEDES-BENZ, PSA, BMW)



YouTube clip



Made in Germany





Das Werkzeug

# Chassis



## 4902/4

EAN-No. 4000896219308

### Inside spring vice set for AUDI, 4 pieces

- Internal guidance of the tensioning jaws prevents spring from sliding out
- For disassembly and assembly of the coil springs on the rear axle (standard chassis)

- AUDI**
- A4 (8K2, B8) 1.8 TFSI, model years 2008 → 2016, A4 (8K2, B8) 2.0 TFSI, model years 2008 → 2016
  - A4 (8K2, B8) 2.0 TDI, model years 2008 → 2016
  - A4 (8K2, B8) 2.7 TDI model years 2007 → 2013
  - A4 Avant (8K5, B8) 1.8 TFSI, model years 2008 → 2016
  - A4 Avant (8K5, B8) 2.0 TFSI, model years 2008 → 2016
  - A4 Avant (8K5, B8) 2.0 TDI, model years 2008 → 2016
  - A4 Avant (8K5, B8) 1.8 TFSI quattro, model years 2008 → 2016
  - A4 Avant (8K5, B8) 2.0 TFSI quattro, model years 2008 → 2016
  - A4 Avant (8K5, B8) 2.0 TDI quattro, model years 2008 → 2016
  - A4 Avant (8K5, B8) 3.2 FSI quattro, model years 2008 → 2012
  - A4 Avant (8K5, B8) 3.0 TDI quattro, model years 2008 → 2012

- Pendulum 6-point head provides a uniform distribution of power with the integrated twist protection
- Both-sided counterholder of the spindle possible
- Plastic box with foam inlay
- **Contents (4-piece set):**
  - 1 inside spring vice 4902-4
  - 1 tensioning jaw 4902-28
  - 1 tensioning jaw 4902-29
  - 1 tubular box wrench 4902-224, s 24 mm

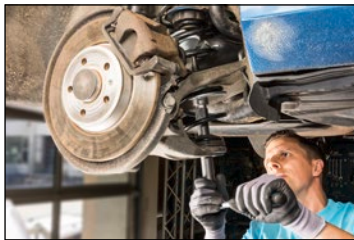
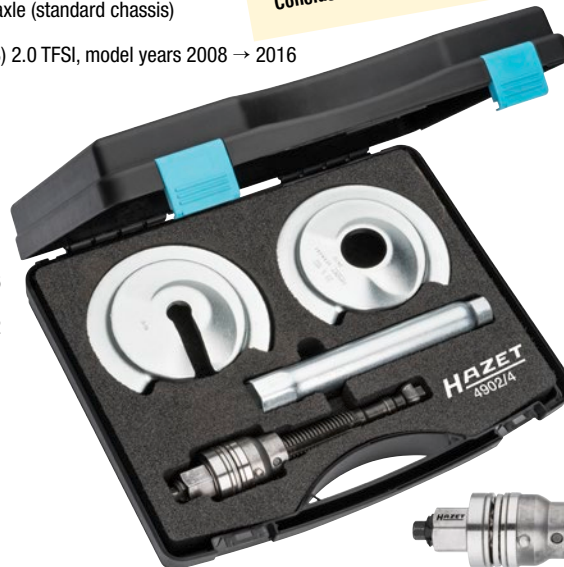

Made in Germany



**Tip for users:**

- Easy handling for just one user
- Removal of surrounding components and time-consuming extra work is no longer necessary for spring disassembly:
  - No need for disassembly of axle parts
  - Axle alignment not necessary
  - Disassembly and assembly possible in just 6 minutes per side

**Conclusion: Tremendous time saving!**

4

YouTube clip



## 4902/6, EAN-No. 4000896121694

### Inside spring vice set

- Installation and removal of the coil spring on the rear axle
- Optimally coordinated to the confined spaces in the following vehicles

- BMW**
- 1-series E87 hatchback model years 2003 → 2011
  - E81 hatchback model years 2006 → 2013
  - E82 coupé 2006 → 2014
  - E88 convertible model years 2007 → 2015
  - X1 E84 model years 2009 - 2015
  - 3-series E90 notchback model years 2004 → 2012
  - E91 touring model years 2004 → 2013
  - E92 coupé model years 2005 → 2013
  - E93 convertible model years 2005 → 2013

- Pendulum 6-point head for uniform distribution of power
- With integrated anti-twist protection
- Internal guidance of the tensioning jaws prevents spring from sliding out
- Both-sided spindle operation possible
- Plastic box with soft foam insert

- **Contents (6-piece set):**
  - 4902-1, -10, -11, -210, -224
  - 4910-1

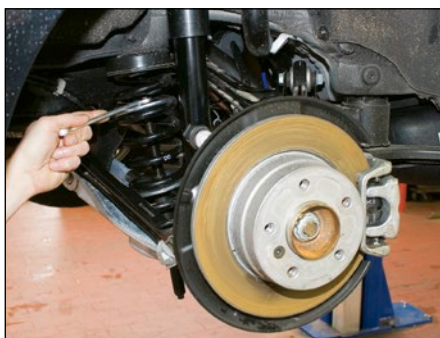
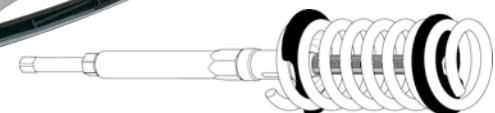

Made in Germany

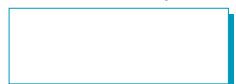

6

YouTube clip



TecAlliance

Data supplied





## 4903/4

EAN-No. 4000896180561

### Stationary universal spring vice

#### New seating and assembly concept

- Swivelling in horizontal or vertical working position
- HAZET recommendation for ergonomic working height: adjust vertically, operate horizontally
- Damage to shock absorbers and head plates impossible (no overload risk)
- Simple, lockable strut mount

#### High safety

- Consistently reliable mounting of head plates
- Thread damage to piston rod impossible
- Permanent fixation of spring throughout operation

#### Secure investment by using existing components of SYSTEM 4900

- Existing basic units 4900-2 A and all tensioning jaws of System 4900 may be used
- Use of future applications is assured

#### Allows record keeping by scaling

- If recurring, significant time savings by scaling
- Firm fixation eliminates readjustment at the same spring strut (left / right)

#### Can be used for almost any strut / shock absorber among others for MERCEDES-BENZ, W203

#### Load-free disassembly / assembly with completely relieved shock absorber

- ❶ 4900-2 A basic unit
- ❷ 4903-1 basic support
- ❸ 4903-2 clamping disc (adjustable)
- ❹ 4903-3 tensioning jaw (adjustable)
- Ⓜ safety adapter included (Ⓜ)

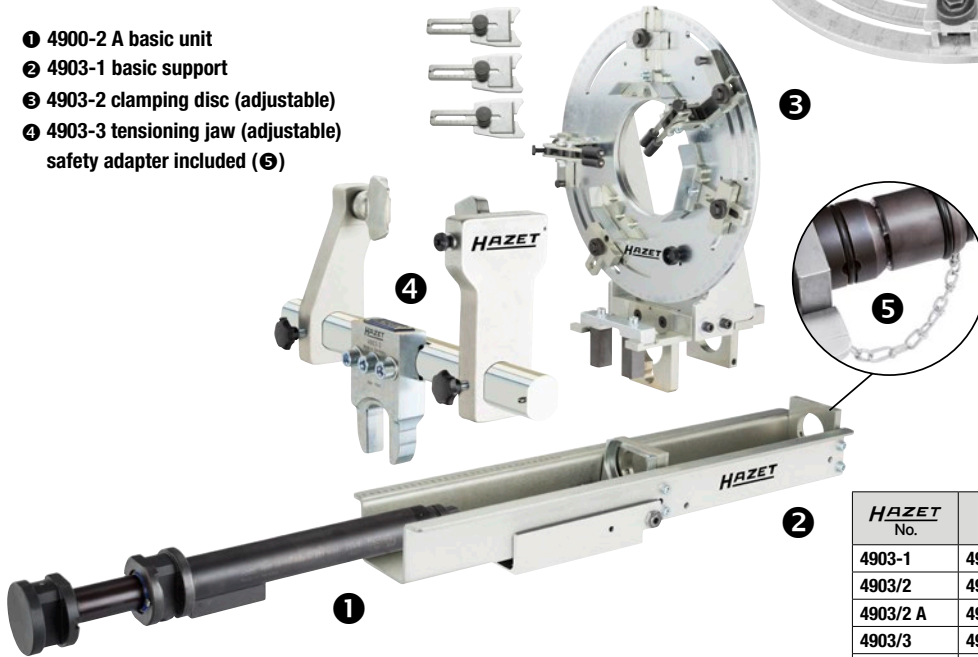

Application video 4903/4 W 203



Application video 4903/4



Made in Germany

HAZET No.	Description	EAN-No. 4000896 +
4903-1	4903-1	179824
4903/2	4903-2 + 4903-3	180530
4903/2 A	4903-1 + 4900-2 A	180547
4903/3	4903-1 + 4903-2 + 4903-3	180554
4903/4	4903-1 + 4903-2 + 4900-2 A + 4903-3	180561

Safety spring vice 4903/4



Spring strut fixation



Swivelling

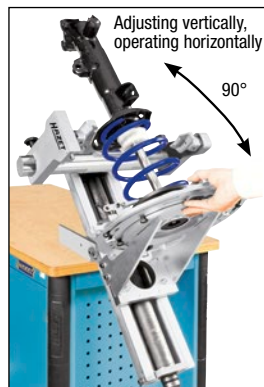

Optimum working height approx. 1,30 m

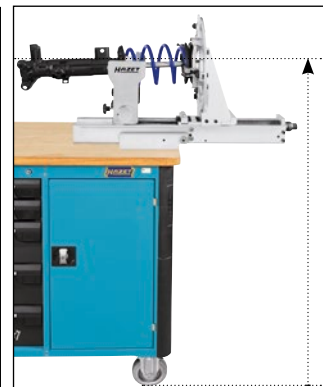

Operating

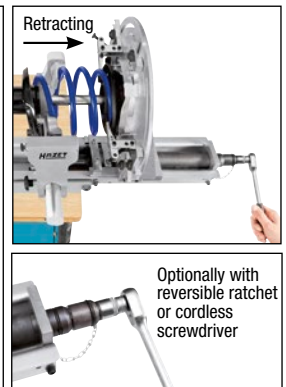



Das Werkzeug

# Chassis



**4900-2 A/5**, EAN-No. 4000896086054

## HAZET Safety spring vice set

- Suitable for impact wrenches
- Closed system – maintenance-free!
- Variable system thanks to easily replaceable tensioning jaws
- With socket rail for machinist's vice
- No further specialty tool necessary

**Contents (5-piece set):**

1 basic unit and 4 tensioning jaws, 2 x 4900-11 and 4900-12 each  
 May be used for approx. 100 different vehicle types



4900-2 A



2 x 4900-12



2 x 4900-11

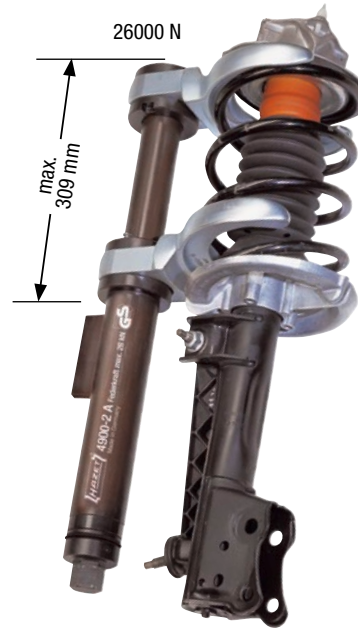

26000 N

max. 309 mm

5

YouTube clip



Further information:



Made in Germany

**4915/15**, EAN-No. 4000896179213

## Shock absorber tool set

- For repair work at the spring strut e.g. shock absorber, strut mounting, coil spring
- For retaining the piston rod when removing and installing the spring strut
- Attention: Follow vehicle manufacturer's specifications concerning torque values
  - Use with torque wrench e.g. HAZET 6291-1 CT together with insert box-end wrench 6630 d-21
  - Application of an impact wrench may damage the thrust bearing and the piston rod



12<sup>5</sup> 1/2 15

**2780-1**, EAN-No. 4000896082858

## Shock absorber crown wrench

- For operating the upper journal screw connection in MERCEDES-BENZ Type 203 (C-Class from 2000)



Made in Germany

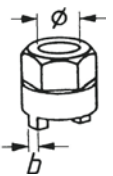

HAZET No.	∅ mm	mm	b mm
2780-1	14,1	22	2,6

**4912-4**, EAN-No. 4000896222551

## Spreader for wheel bearing housing

- For extending spring strut and supporting joint supports (for disconnecting the spring strut from the wheel bearing housing), e.g. on MERCEDES-BENZ Sprinter, Type 910 with front wheel drive since 2018



7,8 x 11 mm

12<sup>5</sup> 1/2

Made in Germany

**NEW!**

## 4912 Other spreaders for wheel bearing housing

12<sup>5</sup> 1/2



5.5 x 8 mm



5 x 7 mm



6 x 8 mm

Made in Germany

HAZET No.	Application	∅	EAN-No. 4000896 +
4912-1	Application e.g. in VW Fox model years 2005 →, Polo model years 2002 →, New Beetle, Golf model years 1998 to 2004, Tiguan model years 2008 →, Eos model years 2006 →, Passat model years 2006 →, Touran model years 2003 →, Caddy model years 2004 →, T5 model years 2004 → AUDI A2 model years 2001 →, A3 model years 2004 →, A4 model years 2001 to 2008, A5 model years 2008 →, A6 model years 2008 →, TT model years 2007 → SEAT, SKODA	5.5 x 8 mm	156368
4912-2	Application on e.g. RENAULT, PEUGEOT, CITROËN	5 x 7 mm	155804
4912-3	Application e.g. for BMW · MINI	6 x 8 mm	217427









## Impact screwdriver socket set

### 900 SZ6/11, EAN-No. 4000896225378 **NEW!**

- Drive: Square hollow  with new outside 6-point  $s$  24 mm on socket for connection with HAZET adapter 1003 S-1 to 
- With borehole for locking pin or safety spring and groove for o-ring
- Surface: phosphatized, oiled
- Output: Outside 12-point traction profile
- In soft foam insert





Made in Germany

Made in Germany

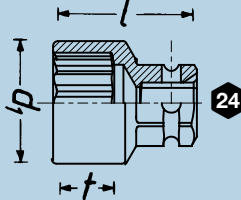
HAZET No.	l mm	d <sub>1</sub> mm	t mm	EAN-No. 4000896+
900 SZ6-19	40	28.8	11.6	225293
900 SZ6-21	40	30	11.7	225309
900 SZ6-22	40	30	11.7	225316
900 SZ6-24	44	35	17.5	225323
900 SZ6-27	45	38.8	17.9	225330
900 SZ6-30	50	42	23.3	225347
900 SZ6-32	50	44.5	22.2	225354
900 SZ6-36	60	50	25	225361



### 985 S **NEW!**

- Drive optionally  or outside 6-point  $s$  24 mm
- Can also be used with HAZET adapter 1003S-1 with  for transmission of high release forces
- For screw connections on commercial vehicles and cars e.g. on chassis, brake systems (brake carriers) and engines
- With borehole for locking pin or safety spring and groove for o-ring
- Supplement for HAZET set 985S/11



Made in Germany

HAZET No.	S mm	l <sub>1</sub> mm	l <sub>2</sub> mm	EAN-No. 4000896+
985 S-22	22	20.5	45	218219
985 S-24	24	-	45	218226

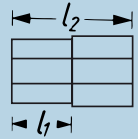



### 1007 S-7/4, EAN-No. 4000896115416

#### Adapter

- With replaceable  impact insert adapter

Made in Germany

HAZET No.	Designation	EAN-No. 4000896+
1007 S-7/4	Impact adapter	215416
1003 S-07	Replaceable impact insert adapter 	215409

The enormous force of the  drive results in high load on and increased wear of the  output.

The 6-point adaption means the  output is replaceable, thereby making the adapter more versatile!



### 990 S/11, EAN-No. 4000896162406

- In soft foam insert



Made in Germany

### 985 S/11, EAN-No. 4000896211951

- In soft foam insert



Made in Germany



## Impact socket set

### 3047-36, EAN-No. 4000896190683 (12-point)

- At only 47 mm  $\varnothing$ , the outer diameter is considerably smaller than conventional standard sockets
- Optimally suited to the given spaces in the wheel hub
- For **OPEL/AUXHALL** Corsa D since 2006, Adam since 2012, Mokka since 2012
- **CHEVROLET** Trax since 2013
- Also suitable for **BMW, SEAT** and **VW** vehicles



Made in Germany



### 900 SZ/4, EAN-No. 4000896156375 (12-point)

- For the operation of screwed connections on drive shafts and cardan shafts
- s 24 mm for **VW** Touran since 2006 and Passat C
- s 30 mm for the axle shaft nut on **VW** Golf 4, Polo, New Beetle, **AUDI** TT 1.8, **ŠKODA** Octavia, Superb, Fabia
- s 32 mm for the operation of screwed connections on cardan shafts in the wheel hub on **VW** Touareg since 2003
- s 36 mm for axle shaft nut on **BMW** 3, 5, 7 series, Z3, M3, **VW** Polo since 2001, Golf Plus 1.8 TDI since 2005, **SEAT** Ibiza since 2002



Made in Germany



### 900 SK/4, EAN-No. 4000896201785 (6-point)

- s 13 17 19 21 mm
- Particularly suitable for 9012 M / 9012 MT

**Extra short!**



**Caution:**

- Follow vehicle manufacturer's specifications concerning torque values
- Operation with impact wrench damages thrust bearings and piston rod!

Made in Germany



### 2534-1

EAN-No. 4000896224227

**NEW!**

### Clamp washer operating tool

- For quick and easy operation of clamp washers
- Prevents damage to underfloor panels and heat shields
- For operating the clamp washers on underfloor panels and heat shields on e.g. **AUDI, SEAT, ŠKODA, VW, FORD**
- Length: 22 mm
- Operating range  $\varnothing$ : 27 mm

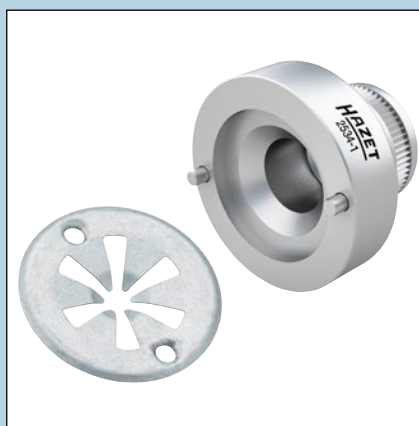
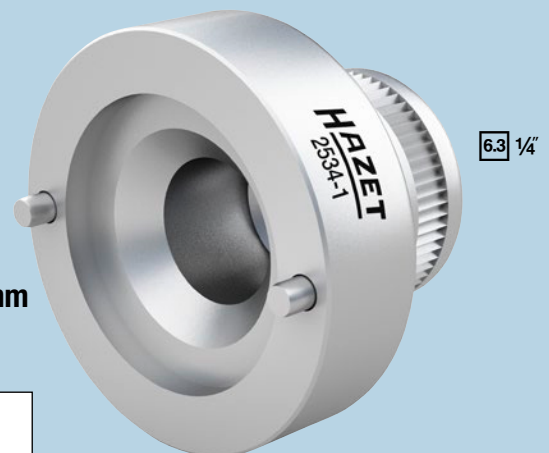

Made in Germany







## 1965/2

EAN-No. 4000896223008

### 2 NEW!

### Universal hook/wedge set, 2 pieces

- Two helpful tools in one set
- For universal use
- Plastic wedge suitable for loosening components, e.g. door clips as well as for lifting and alignment work
- Universal hook for surface-friendly loosening of e.g. window rubber, door seals, carpets, interior trim
- Plastic wedge: Length: 214 mm, width: 26.5 mm
- Universal hook: Length: 180 mm



## 2152 N/3

EAN-No. 4000896204151

### 3

### Electronic set

- Torque tester for motor vehicle electricity and electronics
- For troubleshooting on electronic components
- 3–48 V
- Tension display LED: 5 V, 12 V, 24 V, 48 V
- Polarity display: LED for positive or negative, AC voltage with illuminated LED
- Probe tip, needle with sliding mechanism,
- Additional: Crocodile clip and probe tip for attaching



## 4670-1/12, EAN-No. 4000896132898

### System cable release tool assortment

- Basic set for approx. 80% of all passenger car plug contacts

**OEM quality!**

Examples:



**Made in Germany**

Comprehensive range of system cable release tools, see also Tool catalogue 2019 from page 444

### 12

## 2598-1, EAN-No. 4000896204144

### Door handle tool

- For the operation of the locking hooks when removing/installing the door handle
- Disassembly and assembly of the closing cylinder housing (door handle) with doors without closing cylinders (operation of the hard-to-reach locking hook of the bearing support)
- For e.g. VW Passat model years 2005 →, Tiguan model years 2008 →, Golf 6 model years 2008 →, Golf 7 model years 2012 →, Amarok model years 2010 →, Beetle model years 2011 →
- For the assembly of the door lock VW Fox model years 2005 →



**Made in Germany**

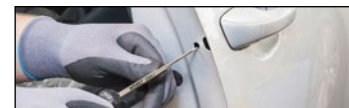

## 428-3.5

EAN-No. 4000896218509

### Radar head nut-driver

- ACC: Adaptive-Cruise-Control for e.g. AUDI / VW vehicles

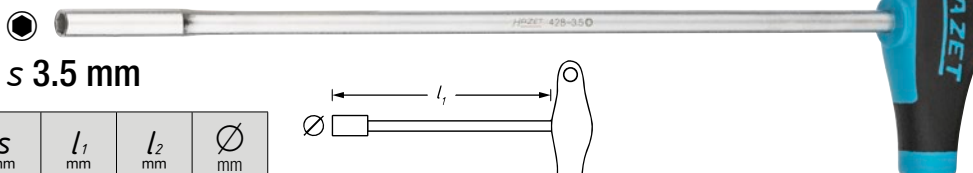

s 3.5 mm

S mm	l <sub>1</sub> mm	l <sub>2</sub> mm	Ø mm
3.5	230	256	7.2

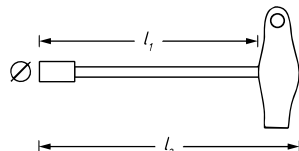

**Made in Germany**

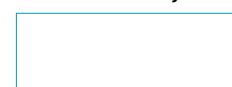



**NEW!**

*Assistant*<sup>®</sup>

179NXL-8/321

EAN-No. 4000896224395



179NXL-8  
 Made in Germany

Tool trolley  
 with 321 expert  
 tools!



Das Werkzeug

+  
**CUP FOR  
 FREE!**



163-549/160

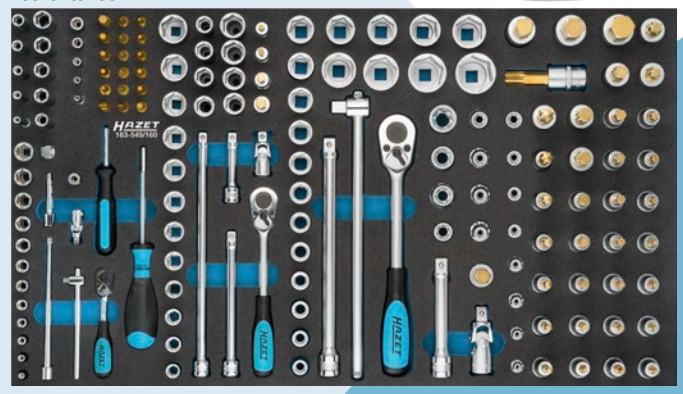

163-478/40



163-479/26



163-480/57



163-522x50

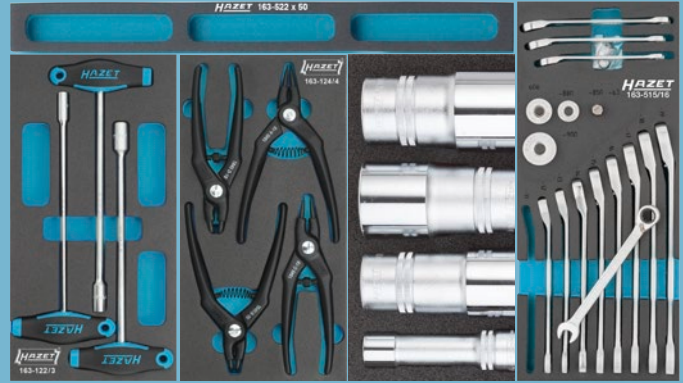

163-122/3

163-124/4

163-459/15

163-515/16

Your HAZET specialist dealer

